

GB | PROGRAM 2014
2015

Q-railing®

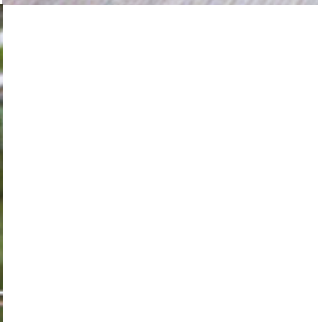



Your choice in railing systems



MOD 0775
14.0775.001.12 95



MOD 55
14.55xx.001.12 95



MOD 29
14.29xx.001.12 96



MOD 29
14.29xx.000.12 96



MOD 0774
14.0774.042.12 100
14.0774.048.12 100



MOD 8926
13.8926.233.12 98



MOD 9328
14.9328.033.12 97



MOD 9329
14.9329.033.12 97



MOD 0547
14.0547.054.12 92



MOD 0548
14.0548.054.12 92



MOD 3503
14.3503.054.00 93



MOD 9012
14.9012.051.12 92



MOD 4925 / 4900
14.4925.262.12 125
14.4900.262.12 125



MOD 4312
14.4312.262.12 126



MOD 4320
14.4320.262.12 126



MOD 5792
14.5792.262.00 126



MOD 4901
14.4901.063.12 122



MOD 5728
14.5728.063.12 122

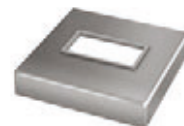

MOD 4513
14.4513.063.12 123

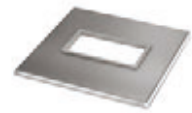

MOD 4512
14.4512.063.12 123



MOD 4558
14.4558.063.12 123



MOD 280x
13.280x.000.12 173
14.280x.000.12 173



MOD 7401
13.7401.3xx.12 162
14.7401.3xx.12 162



MOD 7402
13.7402.3xx.12 162
14.7402.3xx.12 162



MOD 7403
13.7403.3xx.12 162
14.7403.3xx.12 162

Over 125 brand new products

NEW



MOD 9325 
14.9325.042.12 99
14.9325.048.12 99



MOD 9326 
14.9326.042.12 99
14.9326.048.12 99



MOD 6940 
14.6940.030.12 54



MOD 0149 
13.0149.000.12 176



MOD 0520 
13.0520.066.12 176
14.0520.066.12 176



MOD 0148 
13.0148.000.12 183



MOD 0143 / 0144 
13.0143.044.12 182
14.0143.044.12 182



MOD 4819 
14.4819.042.12 99
14.4819.048.12 99



MOD 0521 
24.0521.033.19 98



MOD 5792 
13.5792.233.00 98



MOD 4711 
14.4711.042.12 125
14.4711.048.12 125



MOD 4711 
14.4711.000.12 125



MOD 0147 
13.0147.044.12 182
14.0147.044.12 182



MOD 6738 
13.6738.042.12 66
13.6738.048.12 66



MOD 6320 
14.6320.042.12 64
14.6320.048.12 64



MOD 0142 
13.0142.044.10 219
14.0142.044.10 219



MOD 0520 
13.0520.066.10 219
14.0520.066.10 219



MOD 0148 
13.0148.044.10 220
14.0148.044.10 220



MOD 0051 
41.0051.242.12 234
41.0051.248.12 234



MOD 0013 
19.0013.000.00 237

INDEX

1 GLASS RAILING SYSTEMS

11 - 72



COMPONENTS FOR RAILING BASES

LINEAR FIXATION

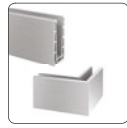

Top mount
Easy Glass® Slim 19 - 21
Easy Glass® 3kN 28 - 31



Fascia mount
Easy Glass® Slim 22 - 26
Easy Glass® 3kN 32 - 36

GLASS INFILLS



Q-glass (16,76 mm) 52

POINT FIXATION



Top mount
Base glass clamps 38 - 40



Fascia mount
Glass adaptors
- Blok 41 - 46
- Ø 50, 60, 70, □ 50 mm 47 - 50

U-PROFILES AND COMPONENTS FOR CAP RAILS



Square 54, 55 - 58
Rectangular 59 - 61



Oval 62
Round 63 - 72

2 BALUSTER RAILING SYSTEMS

73 - 252



COMPONENTS FOR RAILING BASES

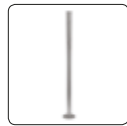

Quickrail® 82
Linear Line 92 - 93
Square Line® 40x40 102 - 108
Square Line® 60x30 122 - 123

Q-line 129 - 143
Q-line polished 212 - 213
Welding parts 226 - 228
Ultra Range (2205 stainless steel) 248

COMPONENTS FOR INFILLS

GLASS INFILLS

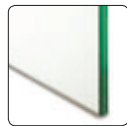

Q-glass (8,76 mm) 85, 148
Quickrail® Glass frame tube 84 - 86
Linear Line 95 - 96, 100

Q-line Glass frame tube 145 - 148
Q-line polished 214 - 216
Ultra Range (2205 stainless steel) 249

Glass infill holders: see chapter 3

TUBE AND BAR INFILLS



Quickrail® 87 - 88
Linear Line 97 - 98
Square Line® 40x40 109

Square Line® 60x30 109
Q-line 150 - 159
Q-line polished 217

CABLE INFILLS



Quickrail® 89
Square Line® 40x40 161 - 167

Square Line® 60x30 161 - 167
Q-line 161 - 167

WEB INFILLS - EASY Q-WEB®

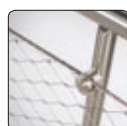

Square Line® 40x40 169 - 171
Square Line® 60x30 169 - 171

Q-line 169 - 171

COMPONENTS FOR INFILLS

PLATE INFILLS

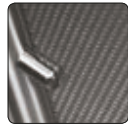

Square Line® 40x40
Square Line® 60x30

172 - 174
172 - 174

Q-line
Q-line polished

172 - 174
218

COMPONENTS FOR HANDRAILS



Quickrail®
Linear Line
Square Line® 40x40
Square Line® 40x10
Square Line® 60x30
Q-line

90
99, 100
110 - 117
119 - 120
125 - 126
175 - 210

Q-line polished
Welding parts
Q-lights
Bendywood
Naturail
Ultra Range (2205 stainless steel)

219 - 224
228 - 232
234 - 239
241
243 - 246
250 - 252

3 GLASS INFILL HOLDERS 253 - 294



Glass clamps
Glass clamps Ultra Range
(2205 stainless steel)
Glass clamps polished

260 - 284
249
214 - 216



Glass connectors
Hinges
Door locks

287
288
289



Glass adaptors
- Spider
- Ø 25, Ø 30, Ø 50 mm

290 - 292
293 - 294

4 ACCESSORIES 295 - 320



Rubber inlays
Cover caps
Security pins
Fixing materials
Accessories for railing systems
Consumable articles

298 - 299
299
299
301 - 310
311
312

Care and maintenance
Drilling and tapping
Tools
Displays
Promotion

313
314
315 - 317
318 - 319
319 - 320

5 SERVICE 321 - 369



Prefix (prefabricated products)
Drilling, milling

324 - 336
337, 338, 365

Cutting
2D and 3D bending

338 - 351
353 - 369

INFORMATION 80, 370 - 380

Tested/Static calculation (baluster railing systems)
Order form

80
370

Keyword index
Icon index

371 - 374
379

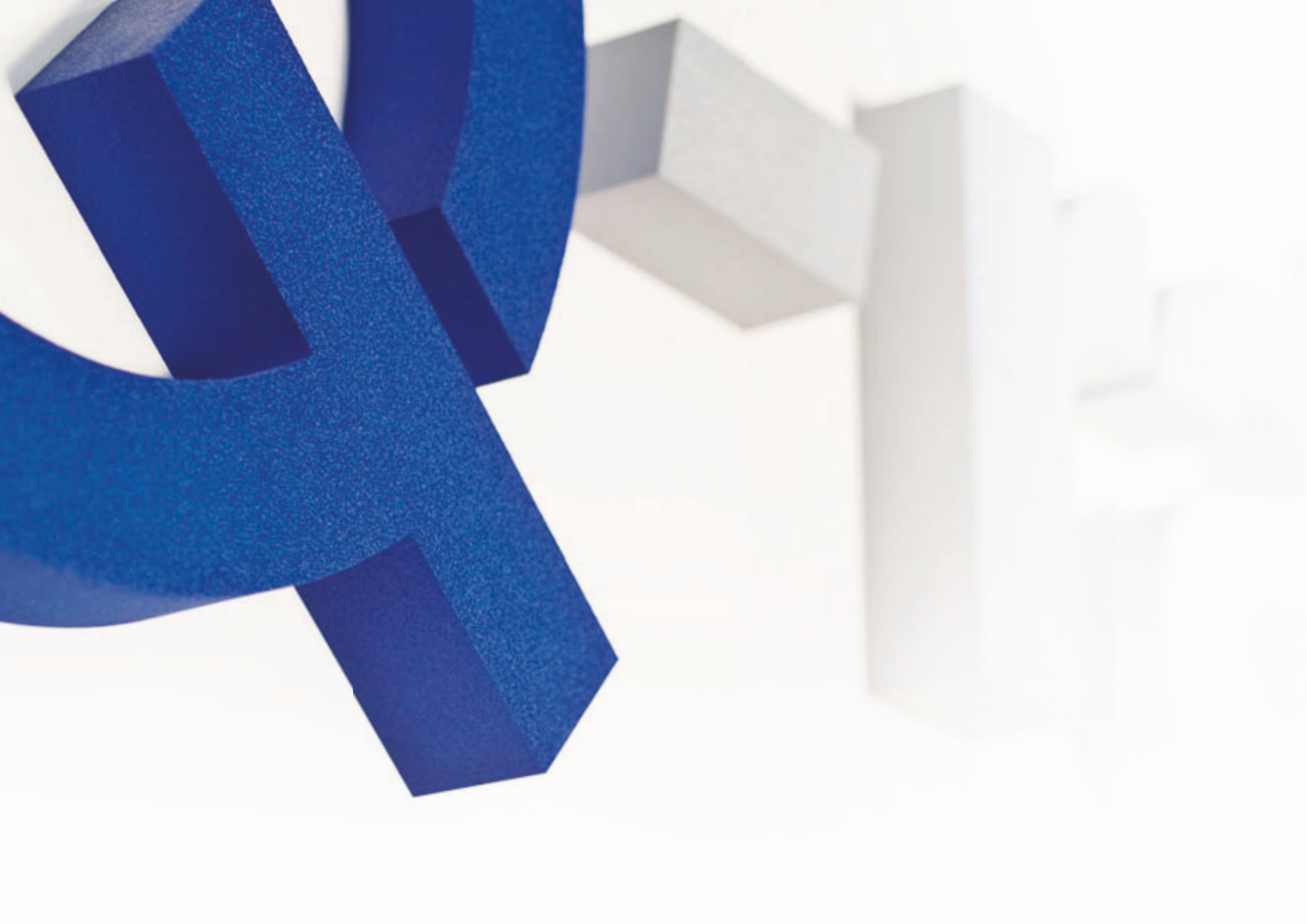

Q-RAILING

Welcome to Q-railing, your source for innovative, high grade, designer railing systems and glass balustrades. Our products function as supports and handrails along steps and stairways, and as safety barriers around balconies and between floor levels.

Q-railing offers fully modular systems and over 4,000 individual railing parts. You can choose coordinated components from one system, or combine products from any of our various systems to create a completely unique look!

Safety – and the reliable quality upon which safety depends – always comes first. Q-railing is ISO 9001:2008 certified. Our products have been thoroughly tested by internationally-leading Enforcing Authorities and come with a number of quality marks and

certifications for various countries; all of our stainless steel, aluminium and glass products have a CE qualification. It's no surprise that you will find our railing systems and balustrades installed around the world in homes, shops and malls, as well as in offices and public buildings, museums, stadiums and airports.



Management System
ISO 9001:2008
ID 9105072449

WHY Q-RAILING?

Quality

Get the high quality your projects demand

- Consistent surfaces and colours
- Extremely accurate measurements and tolerances
- No need for reworking

Easy ordering

Start construction without delay

- 99% of products are immediately available from stock
- 24/7 ordering in our Webshop
- Phone and email ordering available during business hours
- Same-day shipping for orders placed before 12.00 on business days for in-stock items

Wide range

Choose from a large variety of railing system items

- Everything is modular; mix and match among styles and systems
- Designed to be easy to install
- Round, square, oval and flat shapes
- Parts made of stainless steel 304, 316 or 2205, aluminium, wood or zinc

Innovation

Deliver a perfect end result every time

- Approximately 150 new products introduced each year
- We develop new designs and new solutions to make installation even faster and easier
- Products are designed so that welding is not necessary

Safety

Know that all products and systems have been extensively tested

- Products are tested in Q-railing's own test laboratory
- Safety is guaranteed by certification from international testing institutions and internationally-leading Enforcing Authorities

Design

Benefit from our design focus

- Timeless design and stunning aesthetics
- Easy installation methods that provide significant savings during the building process
- Safety and practicality always assured

Customized Prefixing, Cutting and Bending

Let us do the preparatory work for you

- Prefixed baluster posts made to your exact specifications
- Pre-cut bars, tubes and base shoes, all ready for installation
- Custom-bent tubes in 2D or 3D, with absolutely no risk



WHAT YOU NEED TO KNOW ABOUT OUR MATERIALS

Aluminium

Lightweight yet strong, aluminium has a naturally-occurring oxide layer that protects the metal from corrosion. This layer can be further strengthened by anodisation, providing even greater weather resistance. Unless stated otherwise in our catalogue, all of Q-railing's aluminium products are brushed and anodised, making them ideal for both indoor and outdoor use.

Cleaning: Aluminium products can be cleaned with warm water and soap.

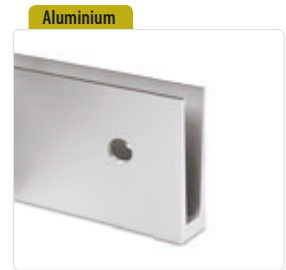

Zinc

Robust and inexpensive, zinc die-cast products can be a cost-effective alternative to other metals. However, because they can corrode, these products should be protected by a varnish or coating, and are only recommended for straightforward indoor use.

Cleaning: Zinc die-cast products can be cleaned with warm water and soap.



304, 316 or 2205?

Although not visible to the naked eye the variance between different grades of stainless steel lies in its composition. As steel is naturally corrosive, different elements are added to make it stainless. The industry standard for interior use is a 304 grade stainless steel. In comparison 316 stainless steel contains 2% molybdenum to make the material more resistant to corrosion caused by cracks, tension and pitting. For outdoor use we normally recommend 316 grade stainless steel as the tougher composition gives better resistance in these harsh environments. However, for swimming pools and coastal areas, stainless steel 316 is not always the most suitable material. This is why Q-railing is the first to provide you with a product range in stainless steel 2205.

The higher nitrogen content and other trace elements of this duplex stainless steel mean that it is even resistant to the aggressive effects of chlorine, salts or high humidity.

The key word with stainless steel is that it is stain 'less' but not completely corrosion-proof as is commonly thought.

We recommend that you should treat the entire structure with Q-ultra-clean as soon as it is installed to clean away any harmful residue. Repeating this on a regular basis will ensure long-lasting perfection.



Cleaning

Stainless steel products can be cleaned with:

- Q-ultra-clean* Which removes dirt and surface corrosion and reinforces the protective passive layer.
- Q-cleaner* A stainless steel cleaning spray that removes stains and enhances shine.
- Scotch®-Brite* Polishing pads to remove scratches.



WHAT PRODUCT QUALITY DO YOU NEED?:

Q-INFO		Zinc	Aluminium	304	316	2205
Category	Suitable for					
Low	Indoor structures (no wet spaces).	✓	✓	✓	✓	✓
Moderate	Indoor structures without noticeable chlorine and sulphur dioxide load (e.g. semi-chemical factories).	✓	✓	✓	✓	✓
Medium	Outdoor structures with moderate chlorine and sulphur dioxide load (e.g. inland, at least 25 km from the coast or other aquatic environments).	✗	✓	✗		✓
High	Outdoor structures with a high degree of corrosion due to chlorine and/or sulphur dioxide load; high humidity; accumulation of harmful substances (e.g. in coastal regions and swimming pool environments).	✗	!	✗	!	
		✗	!	✗	!	



GLASS RAILING
SYSTEMS

1

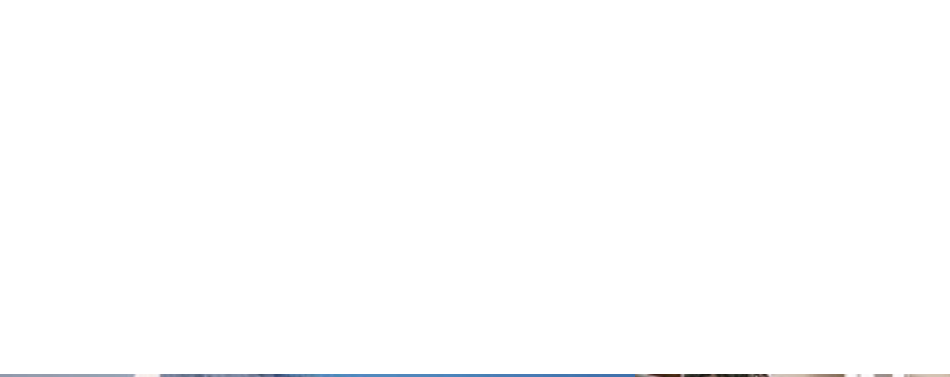

WHERE TRANSPARENCY MEETS DESIGN AND SAFETY

With its base shoes, base glass clamps and glass adapters this is the system that brings you ideal transparency for every possible interior and exterior. Combine the profiles, glass clamps and adapters with one of our Easy Glass® cap rails and Q-glass to get the perfect end result and an expansive sense of space.

When it comes to glass balustrades, it is all about achieving the perfect clear design without sacrificing safety... and Q-railing has done just that with our Easy Glass®. Easy Glass is approved for indoor and outdoor installations and available for light, medium to extra strong use.

The Easy Glass range gives you lots of options. Choices include linear fixation products, such as base profiles, as well as point fixation

products, such as glass adapters or base glass clamps. Combine these with round, square or oval cap rails to create a complete railing with the maximum possible transparency.

This versatile glass railing range gives you a complete system for every situation. Advantages include:

- Savings: Easy and smart installation (just 1-2 hours per metre) saves you time and money.
- Safety: Complies with national and international safety measures (test results available).
- Flexibility: Wide range of options to create the look you want.

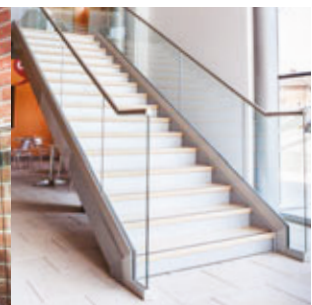
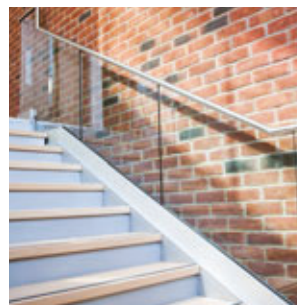
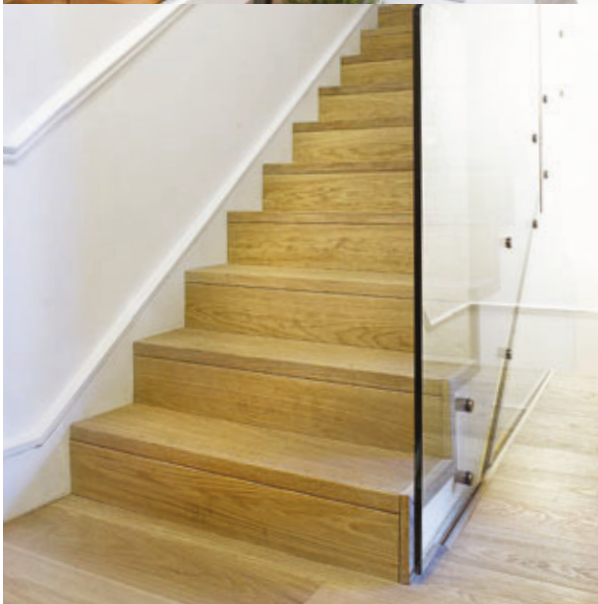



INDEX

GLASS RAILING SYSTEMS

Railing bases - linear fixation



16 - 17

Easy Glass®
Overview base profiles



19 - 21

Easy Glass® Slim
Top mount



22 - 26

Easy Glass® Slim
Fascia mount



28 - 31

Easy Glass® 3kN
Top mount



32 - 36

Easy Glass® 3kN
Fascia mount

Railing bases - point fixation



38 - 40

Easy Glass®
Base glass clamps



41 - 46

Easy Glass® Blok
Glass adapters



47

Easy Glass®
Glass adapters



48

Easy Glass®
Glass adapters
Ø 50 mm



50

Easy Glass®
Glass adapters
Ø 60 / 70 mm

Infills



52

Q-glass (16,76 mm)

Top/handrail



54

U-profiles



55 - 67

Cap rails, connectors and
end fittings -
satin



70 - 72

Cap rails, connectors and
end fittings -
polished



61, 68

Cap rails, connectors and
end fittings -
wood

OVERVIEW EASY GLASS® BASE PROFILES

Which profile is right for your project?

Easy Glass® Slim



The economical solution for light to medium use.

- For top and fascia mounting
- Light and easy to manoeuvre on-site
- With stainless steel finish or metal cladding

































		Use	Possible glass thickness (ESG & VSG from ESG**)
Slim top mount 16.6904.000.18 16.6904.500.18 16.6904.501.18		Light to medium	ESG 12 - 19 mm
			VSG (2 x ESG) 16,76 - 21,52 mm
Slim fascia mount 16.6905.000.18 16.6905.500.18		Light to medium	ESG 12 - 19 mm
			VSG (2 x ESG) 16,76 - 21,52 mm
3kN top mount 16.6908.000.18		Extremely heavy	ESG 19 - 25 mm
			VSG (2 x ESG) 20,76 - 31,52 mm
3kN fascia mount 16.6907.000.18		Extremely heavy	ESG 19 - 25 mm
			VSG (2 x ESG) 20,76 - 31,52 mm

Easy Glass® 3kN



The glass railing system that can cope with heavier loads, for extra strong use as in shopping centers, sports stadiums or museums.

- For top and fascia mounting
- Able to absorb linear side forces of up to 3 kN
- With stainless steel finish or metal cladding

Weight	Installation time	Suitable for stairways	Water drainage	Safety Wedge - No adjusting of the glass (fixed mounting)	Safety Wedge (For adjusting of the glass)	Cladding possible	Certificate*	For glass thickness (VSG from ESG**)	Certificate*	For glass thickness (VSG from ESG**)	Page
6,16 kg/m	1,0 - 1,5 hours/m	✓	✓	✓	-	✓	 16,76 / 17,52 / 20,76 / 21,52 mm  16,76 / 17,52 / 20,76 / 21,52 mm  16,76 / 17,52 / 20,76 / 21,52 mm  16,76 / 17,52 / 20,76 / 21,52 mm	 16,76 / 17,52 / 20,76 / 21,52 mm  16,76 / 17,52 mm  15 / 16,76 / 19 / 21,52 mm  12,76 / 13,52 / 16,76 / 17,52 / 20,76 / 21,52 mm	19 - 21		
5,96 kg/m	1,0 - 1,5 hours/m	✓	✓	✓	-	✓	 16,76 / 17,52 / 20,76 / 21,52 mm  16,76 / 17,52 / 20,76 / 21,52 mm  16,76 / 17,52 / 20,76 / 21,52 mm  16,76 / 17,52 / 20,76 / 21,52 mm	 16,76 / 17,52 / 20,76 / 21,52 mm  20,76 mm  15 / 19 / 21,52 mm  12,76 / 13,52 / 16,76 / 17,52 / 20,76 / 21,52 mm	22 - 26		
12,92 kg/m	1,5 - 2 hours/m	✓	✓	✓	-	✓	 20,76 / 21,52 / 24,76 / 25,52 / 30,76 / 31,52 mm  20,76 / 21,52 / 24,76 / 25,52 / 30,76 / 31,52 mm  20,76 / 25,52 / 30,76 / 31,52 mm  20,76 / 21,52 / 24,76 / 25,52 / 30,76 / 31,52 mm	 20,76 / 21,52 mm  25,52 mm  25 / 25,52 / 31,52 mm  20,76 / 21,52 / 24,76 / 25,52 / 30,76 / 31,52 mm	28 - 31		
12,85 kg/m	1,5 - 2 hours/m	✓	✓	✓	-	✓	 20,76 / 21,52 / 24,76 / 25,52 / 30,76 / 31,52 mm  20,76 / 21,52 / 24,76 / 25,52 / 30,76 / 31,52 mm  20,76 / 25,52 / 30,76 / 31,52 mm  20,76 / 21,52 / 24,76 / 25,52 / 30,76 / 31,52 mm	 20,76 / 21,52 mm  25,52 mm  25 / 25,52 / 31,52 mm  20,76 / 21,52 / 24,76 / 25,52 / 30,76 / 31,52 mm	32 - 36		

*Please note for specifications such as mounting and glass dimension measurements, see the respective certificates.

**VSG (2 x ESG): Laminated glass from toughened glass
ESG : Toughened glass





EASY GLASS® SLIM

The economical solution in our range of minimalist glass railing systems, Easy Glass® Slim's light weight makes its base shoe easy to manoeuvre on site. Plus, the safety wedge system gets installation done in no time! Slim is a complete and affordable solution that includes an integrated water drainage channel for practical use. It is suitable for 12-21.52 mm glass, and looks terrific when finished off with a cap rail.

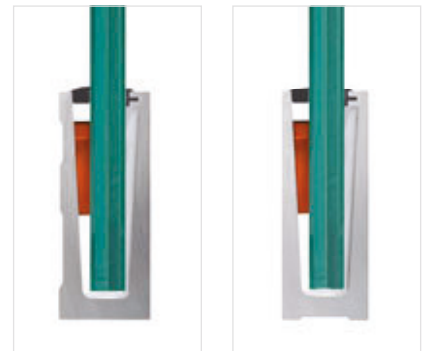

EASY GLASS® SLIM - Base shoe, top mount

15 µ anodisation

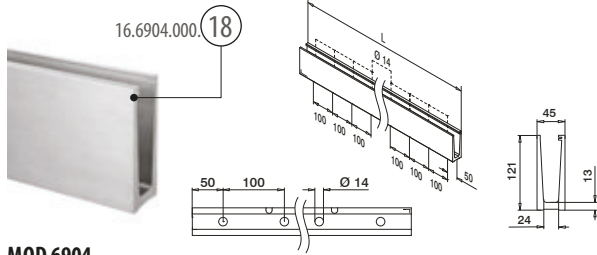

MOD 6904

Aluminium	Stainless steel effect	
INDOOR		
16.6904.501.18	QS-36 309	L = 5000 mm

25 µ anodisation

Aluminium	Stainless steel effect	
OUTDOOR		
16.6904.000.18	QS-519 309	L = 2500 mm
16.6904.500.18	QS-519 309	L = 5000 mm



Without holes

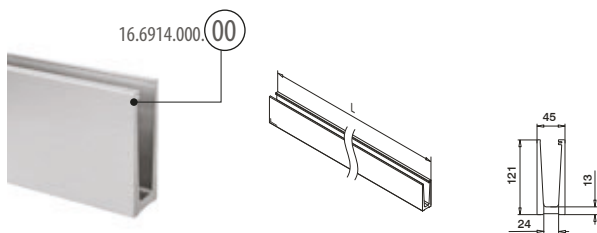

MOD 6914

Aluminium	No stainless steel effect	
INDOOR		
16.6914.500.00		L = 5000 mm



Safety Wedge System:
Glass is being clamped. Drilling is not necessary.

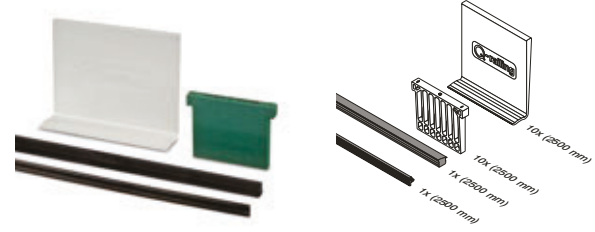

MOD 6904

Accessories		T	
19.6904.912.00		12	L = 5000 mm
19.6904.913.00	12,76 (6 - 0,76 - 6)		L = 5000 mm
19.6904.914.00	13,52 (6 - 1,52 - 6)		L = 5000 mm
19.6904.915.00	15		L = 5000 mm
19.6904.917.00	16,76 (8 - 0,76 - 8)		L = 5000 mm
19.6904.918.00	17,52 (8 - 1,52 - 8)		L = 5000 mm
19.6904.919.00	19		L = 5000 mm
19.6904.921.00	20,76 (10 - 0,76 - 10)		L = 5000 mm
19.6904.922.00	21,52 (10 - 1,52 - 10)		L = 5000 mm

19.6904.512.00	12	L = 25 m
19.6904.513.00	12,76 (6 - 0,76 - 6)	L = 25 m
19.6904.514.00	13,52 (6 - 1,52 - 6)	L = 25 m
19.6904.515.00	15	L = 25 m
19.6904.517.00	16,76 (8 - 0,76 - 8)	L = 25 m
19.6904.518.00	17,52 (8 - 1,52 - 8)	L = 25 m
19.6904.519.00	19	L = 25 m
19.6904.521.00	20,76 (10 - 0,76 - 10)	L = 25 m
19.6904.522.00	21,52 (10 - 1,52 - 10)	L = 25 m

Q-INFO

MOD 6904

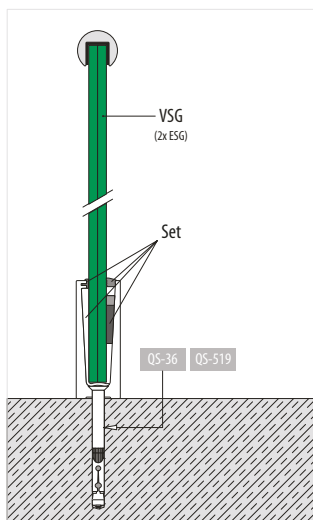

VSG (2x ESG): Laminated glass from toughened glass
ESG : Toughened glass

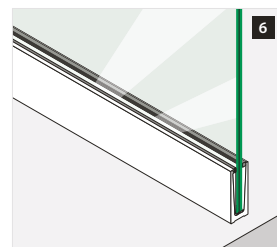
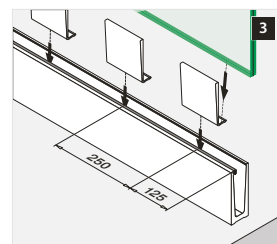
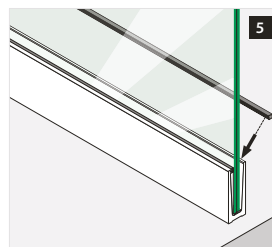
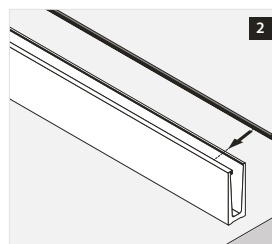
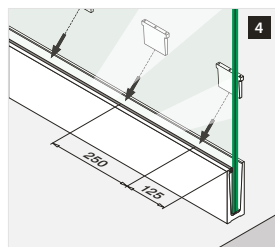
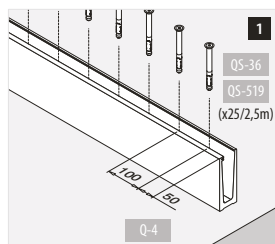

Please note for specifications such as mounting and glass dimension measurements, see the respective certificates.

EASY GLASS® SLIM - Connectors, top mount

Inner corner

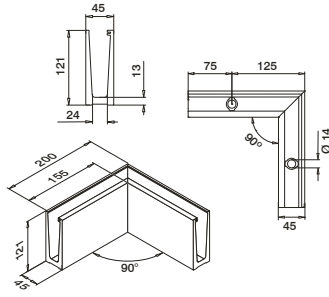

MOD 6313

Aluminium Stainless steel effect

OUTDOOR

16.6313.004.18

QS-519 309



1



Outer corner

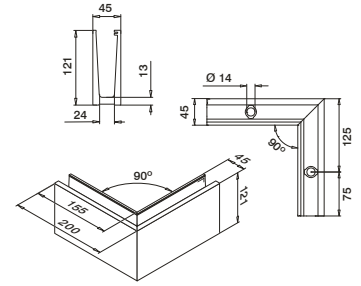

MOD 6314

Aluminium Stainless steel effect

OUTDOOR

16.6314.004.18

QS-519 309



1



EASY GLASS® SLIM - Cladding, top mount

Cladding frontside

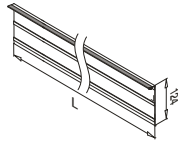

MOD 6920

304

INDOOR

13.6920.004.12



L = 2500 mm

316

OUTDOOR

14.6920.504.12



L = 5000 mm



L=5000mm

Cladding backside

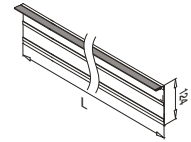

MOD 6921 / 6922

304

INDOOR

13.6921.124.12

T

12



L = 2500 mm

13.6921.134.12

12,76 - 13,52

L = 2500 mm

13.6921.154.12

15

L = 2500 mm

13.6921.174.12

16,76 - 17,52

L = 2500 mm

13.6921.194.12

19

L = 2500 mm

13.6921.214.12

20,76 - 21,52

L = 2500 mm

316

OUTDOOR

14.6922.124.12

T

12



L = 5000 mm

14.6922.134.12

12,76 - 13,52

L = 5000 mm

14.6922.174.12

16,76 - 17,52

L = 5000 mm

14.6922.214.12

20,76 - 21,52

L = 5000 mm



L=5000mm

Q-INFO

MOD 6313 / 6314

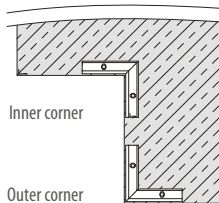

Inner corner

Outer corner

Q-INFO

MOD 6904 / 6914

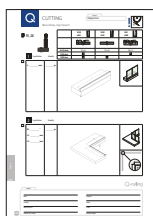

We can cut this article for you based on your specifications for length and required angles. Contact us for details, or see the 'Cutting' information on page 344, 345, 346, 350.

Q-INFO

MOD 6920 / 6921 / 6922

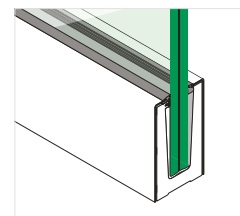
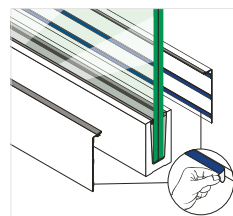

EASY GLASS® SLIM - End fittings and drainage profiles, top mount



Use without cladding
Left + right applicable

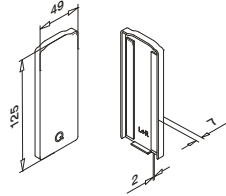

MOD 6734

Aluminium	Stainless steel effect	
OUTDOOR		
16.6734.004.18		1



Use with stainless steel cladding
Left + right applicable

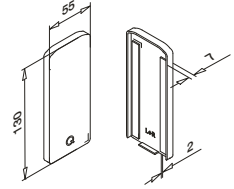

MOD 6734

Zinc	Stainless steel effect	
OUTDOOR		
10.6734.004.20		1



Use without cladding
For stairs
Left + right applicable

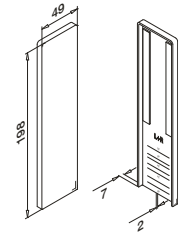

MOD 6736

Aluminium	Stainless steel effect	
OUTDOOR		
16.6736.004.18		1

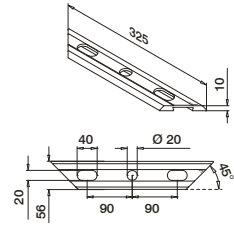

MOD 6948

Aluminium	Stainless steel effect	
OUTDOOR		
16.6948.004.18		8



International Design Model Protection

Q-INFO MOD 6734

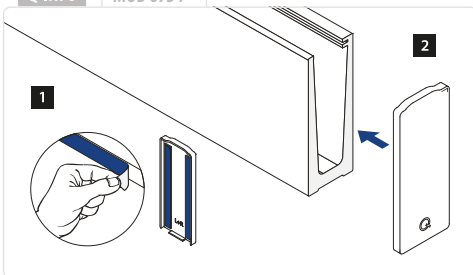

Q-INFO MOD 6736

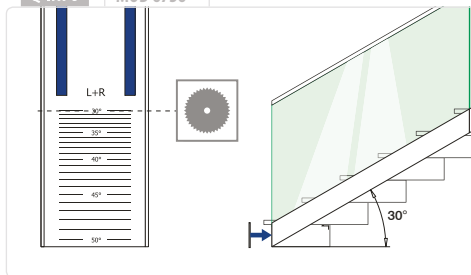

Q-INFO MOD 6948

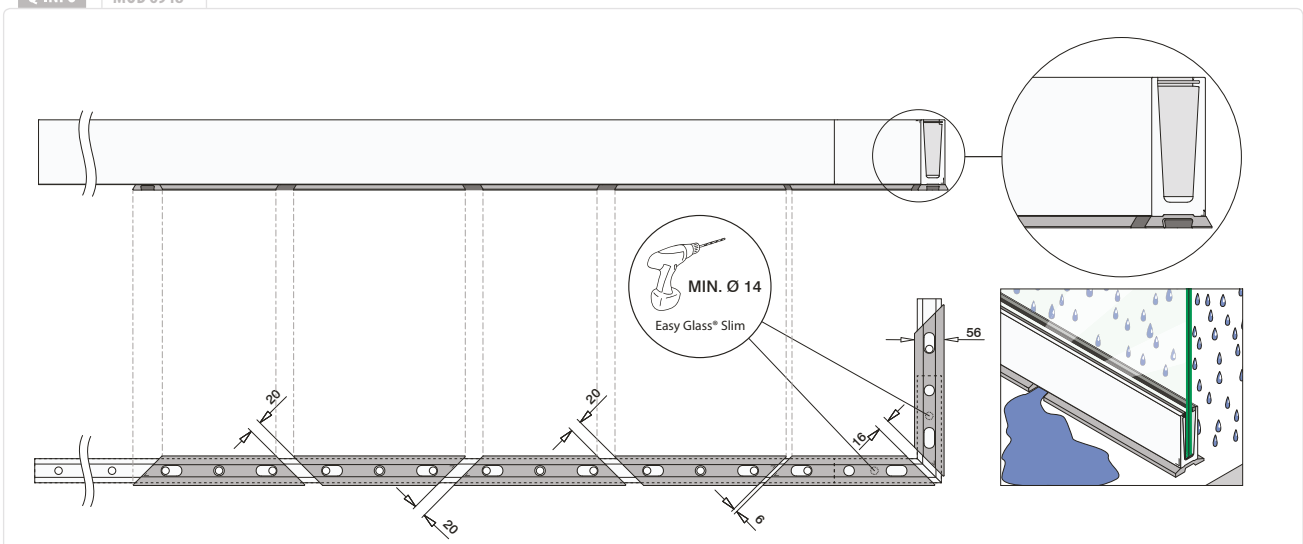

EASY GLASS® SLIM - Base shoe, fascia mount

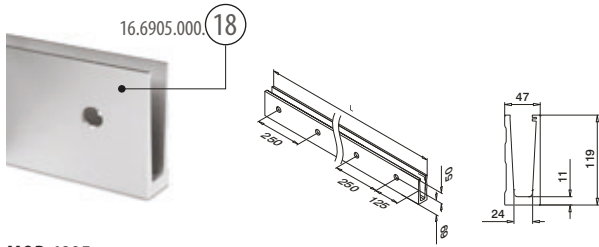

MOD 6905

Aluminium	Stainless steel effect	
OUTDOOR		
16.6905.000.18	QS-519 309	L = 2500 mm
16.6905.500.18	QS-519 309	L = 5000 mm



Safety Wedge System:
Glass is being clamped. Drilling is not necessary.

Accessories

EASY GLASS® - Multitool



MOD 6920

Accessories	Q	
19.6920.000.00	Q-71	1

International Design Model Protection

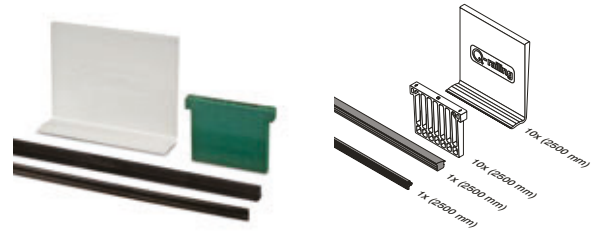

MOD 6904

Accessories	T	
19.6904.912.00	12	L = 5000 mm
19.6904.913.00	12,76 (6 - 0,76 - 6)	L = 5000 mm
19.6904.914.00	13,52 (6 - 1,52 - 6)	L = 5000 mm
19.6904.915.00	15	L = 5000 mm
19.6904.917.00	16,76 (8 - 0,76 - 8)	L = 5000 mm
19.6904.918.00	17,52 (8 - 1,52 - 8)	L = 5000 mm
19.6904.919.00	19	L = 5000 mm
19.6904.921.00	20,76 (10 - 0,76 - 10)	L = 5000 mm
19.6904.922.00	21,52 (10 - 1,52 - 10)	L = 5000 mm
19.6904.512.00	12	L = 25 m
19.6904.513.00	12,76 (6 - 0,76 - 6)	L = 25 m
19.6904.514.00	13,52 (6 - 1,52 - 6)	L = 25 m
19.6904.515.00	15	L = 25 m
19.6904.517.00	16,76 (8 - 0,76 - 8)	L = 25 m
19.6904.518.00	17,52 (8 - 1,52 - 8)	L = 25 m
19.6904.519.00	19	L = 25 m
19.6904.521.00	20,76 (10 - 0,76 - 10)	L = 25 m
19.6904.522.00	21,52 (10 - 1,52 - 10)	L = 25 m

Q-INFO

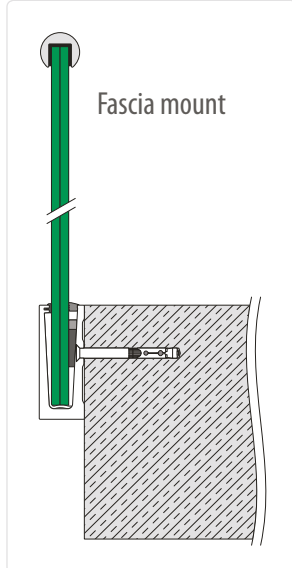

Q-INFO

MOD 6905

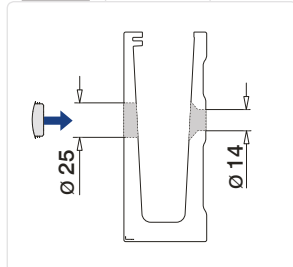

Q-INFO

MOD 6905

We can cut this article for you based on your specifications for length and required angles. Contact us for details, or see the 'Cutting' information on page 347, 348, 349, 351.

Q-INFO

MOD 6920



Q-INFO MOD 6905

Possible applications

Fascia mounting

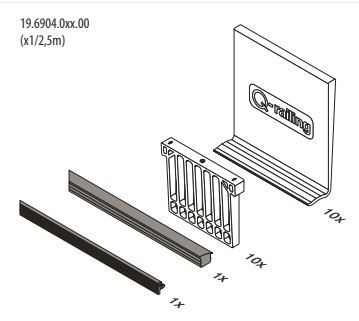
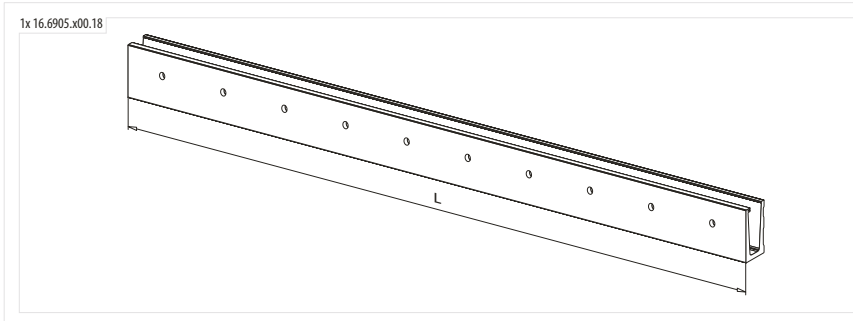
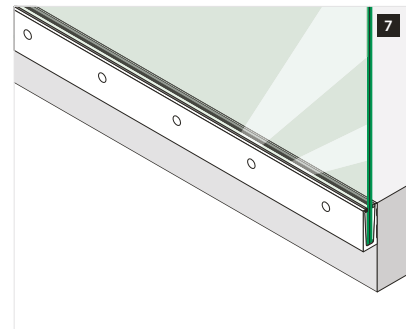
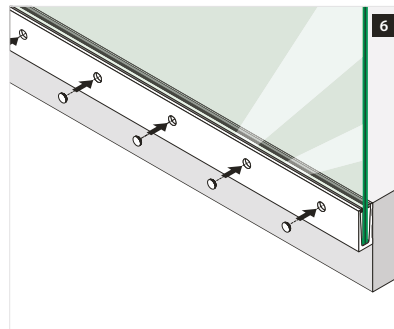
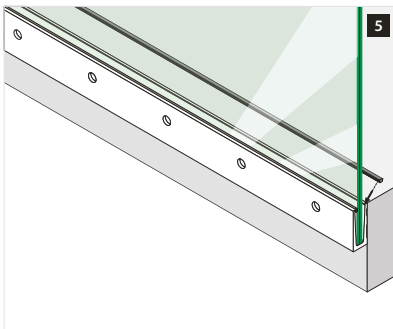
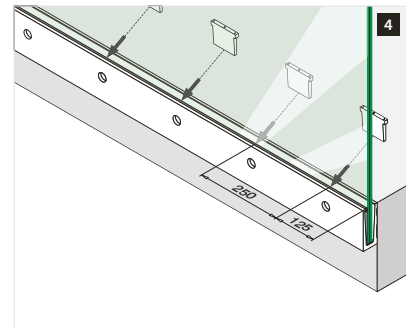
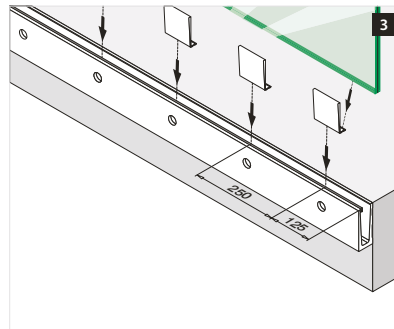
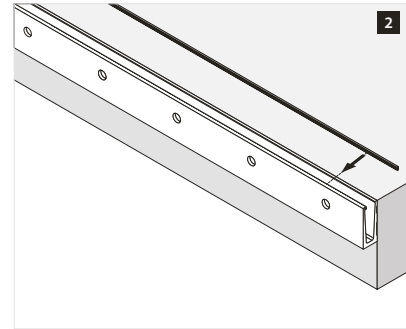
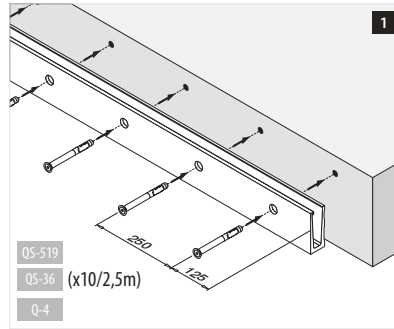
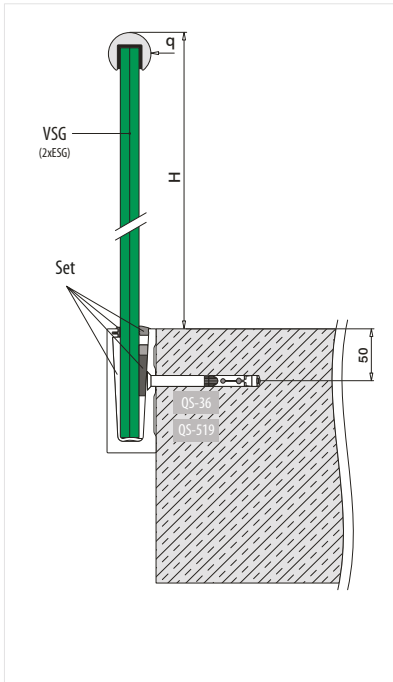

VSG (2x ESG): Laminated glass from toughened glass
 ESG : Toughened glass

Please note for specifications such as mounting and glass dimension measurements, see the respective certificates.

For more information, please visit our website: www.q-railing.com



Q-INFO MOD 6921

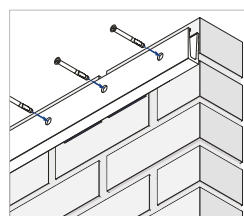
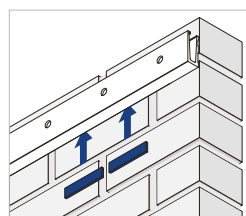

EASY GLASS® SLIM - Connectors, fascia mount

Inner corner

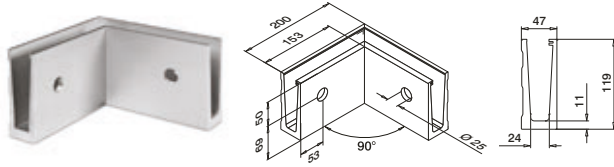

MOD 6315

Aluminium	Stainless steel effect	
OUTDOOR		
16.6315.005.18	QS-36 309 / QS-519 309	1



Outer corner

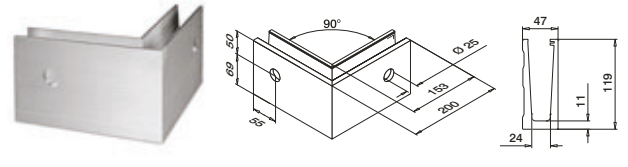

MOD 6316

Aluminium	Stainless steel effect	
OUTDOOR		
16.6316.005.18	QS-520 307 / QS-521 307	1



EASY GLASS® SLIM - Cladding, fascia mount

Cladding frontside



MOD 6920

304		
INDOOR		
13.6920.005.12	L = 2500 mm	
316		
OUTDOOR		
14.6920.505.12	L = 5000 mm	



Cladding frontside



MOD 6920

Aluminium	Stainless steel effect	
OUTDOOR		
16.6920.005.18	L = 2500 mm	

EASY GLASS® SLIM - Blind plugs for fascia mounting

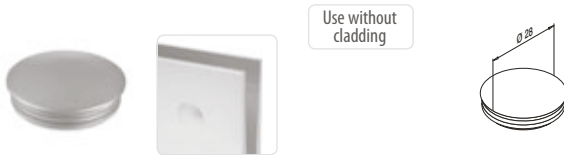

MOD 6922

ABS plastic		
OUTDOOR		
24.6922.007.36		10

Q-INFO MOD 6315 / 6316

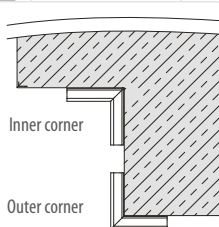

Q-INFO MOD 6922

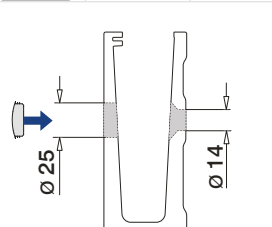

EASY GLASS® SLIM - End fittings, fascia mount - use with cladding

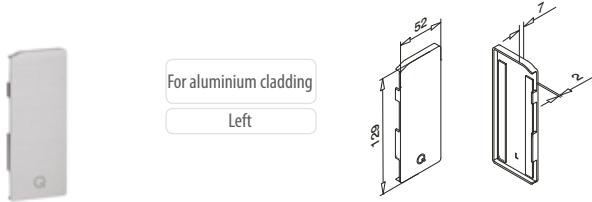

For aluminium cladding
Left

MOD 6734

Aluminium Stainless steel effect
OUTDOOR
16.6734.105.18 1

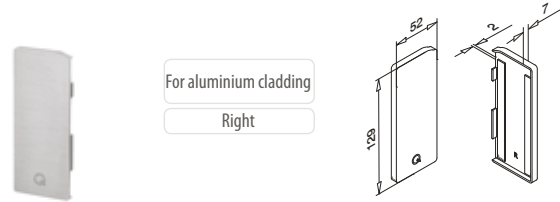

For aluminium cladding
Right

MOD 6735

Aluminium Stainless steel effect
OUTDOOR
16.6735.105.18 1

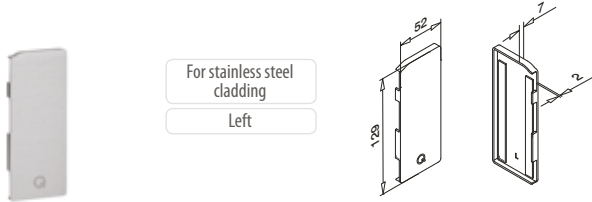

For stainless steel cladding
Left

MOD 6734

Zinc Stainless steel effect
OUTDOOR
10.6734.105.20 1

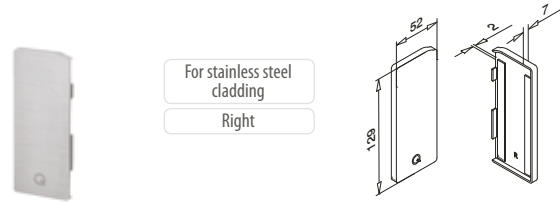

For stainless steel cladding
Right

MOD 6735

Zinc Stainless steel effect
OUTDOOR
10.6735.105.20 1

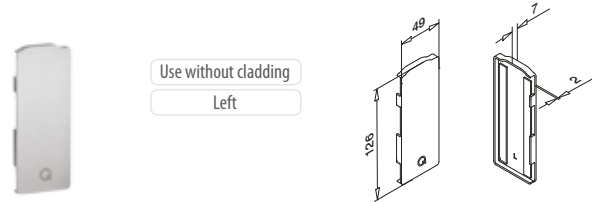

Use without cladding
Left

MOD 6734

Aluminium Stainless steel effect
OUTDOOR
16.6734.005.18 1

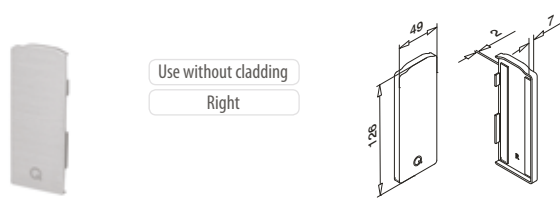

Use without cladding
Right

MOD 6735

Aluminium Stainless steel effect
OUTDOOR
16.6735.005.18 1

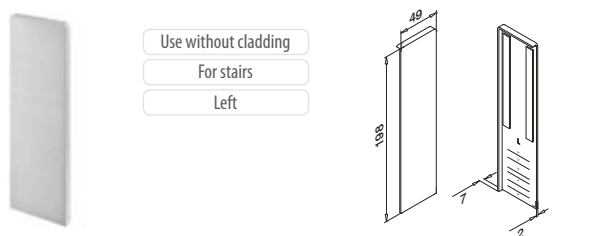

Use without cladding
For stairs
Left

MOD 6736

Aluminium Stainless steel effect
OUTDOOR
16.6736.005.18 1

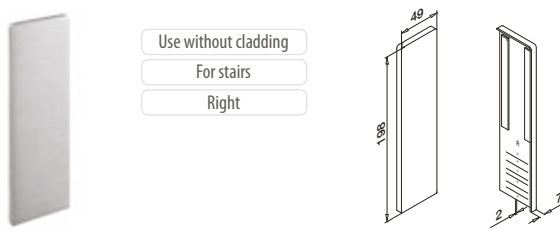

Use without cladding
For stairs
Right

MOD 6737

Aluminium Stainless steel effect
OUTDOOR
16.6737.005.18 1

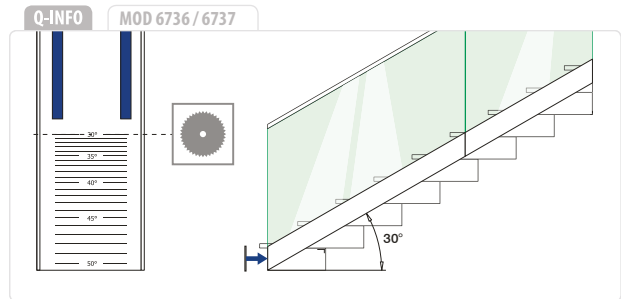
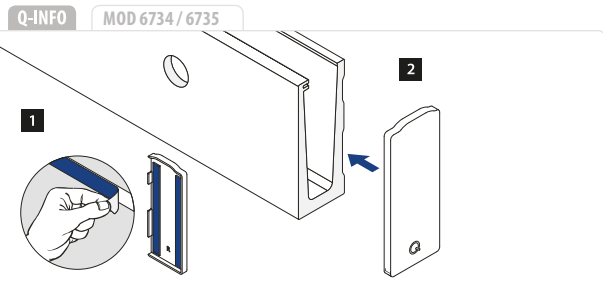

EASY GLASS® SLIM - Mounting plates, fascia mount

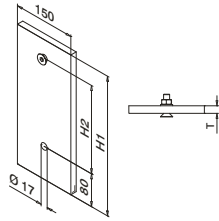

MOD 6951

Zinc-plated		H1	H2	T	
19.6951.250.15	QS-507 307	250	125	12	1
19.6951.340.15	QS-507 307	340	215	15	1

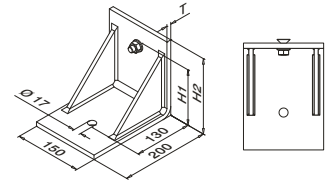

MOD 6952

Zinc-plated		H1	H2	T	
19.6952.120.15	QS-60 307 / QS-61 307	75	120	10	1
19.6952.170.15	QS-60 307 / QS-61 307	125	170	10	1

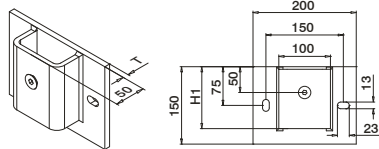

MOD 6953

Zinc-plated		H1	T	
19.6953.150.15	QS-60 307 / QS-61 307	120	10	1

Q-INFO MOD 6951 / 6952 / 6953

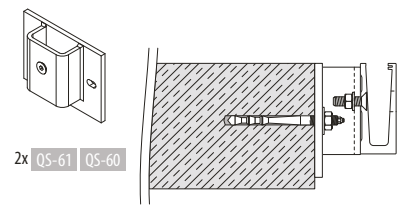
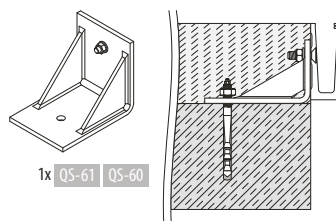
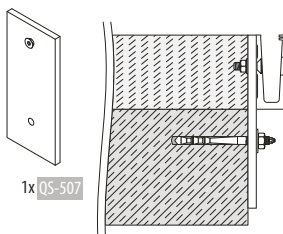



EASY GLASS® 3KN

Q-railing's 3kN was designed to cope with a heavy load while providing transparency to create visibility and an invigorating sense of freedom. The system is suitable for 19 - 31.52 mm glass and able to absorb linear side forces up to 3kN while meeting worldwide safety and building regulations. The system is easily installed on site, with no welding required - our safety wedge system guarantees the perfect connection between the glass and the base shoe. To top it off, finished cap rails are available in a wide range of materials and sizes.



GOEDKEURING
VOLGENS BB2012
EUROCODES
1990-1999:2011
NEN 2608

GOEDKEURING
VOLGENS BOUWBESLUIT
NEN 6702
NEN-EN 1991-1-1

**APPROVED
to BS 6180**



EASY GLASS® 3KN - Base shoe, top mount

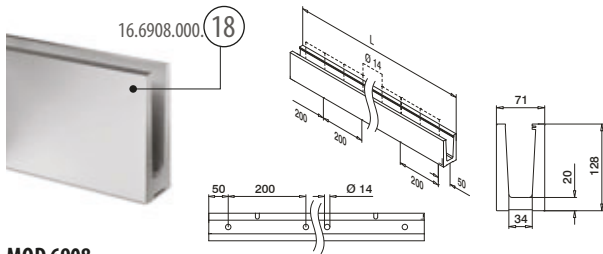

MOD 6908

Aluminium Stainless steel effect
OUTDOOR
 16.6908.000.18 QS-73 307 / QS-74 303 L = 2500 mm

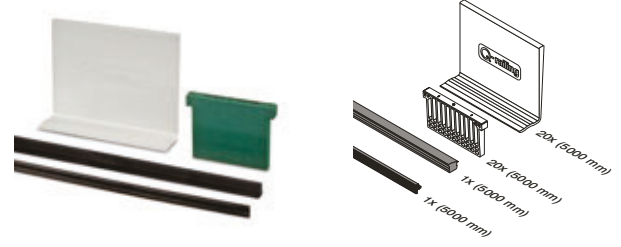

MOD 6907

Accessories		
	T	
19.6907.919.00	19	L = 5000 mm
19.6907.921.00	20,76 (10 - 0,76 - 10)	L = 5000 mm
19.6907.922.00	21,52 (10 - 1,52 - 10)	L = 5000 mm
19.6907.924.00	24,76 (12 - 0,76 - 12)	L = 5000 mm
19.6907.925.00	25	L = 5000 mm
19.6907.926.00	25,52 (12 - 1,52 - 12)	L = 5000 mm
19.6907.932.00	31,52 (15 - 1,52 - 15)	L = 5000 mm
19.6907.519.00	19	L = 25 m
19.6907.521.00	20,76 (10 - 0,76 - 10)	L = 25 m
19.6907.522.00	21,52 (10 - 1,52 - 10)	L = 25 m
19.6907.524.00	24,76 (12 - 0,76 - 12)	L = 25 m
19.6907.525.00	25	L = 25 m
19.6907.526.00	25,52 (12 - 1,52 - 12)	L = 25 m
19.6907.532.00	31,52 (15 - 1,52 - 15)	L = 25 m

Accessories

EASY GLASS® - Multitool



MOD 6920

Accessories
 19.6920.000.00 Q Q-71 1

International Design Model Protection

Safety Wedge System:
 Glass is being clamped. Drilling is not necessary.

Q-INFO MOD 6908

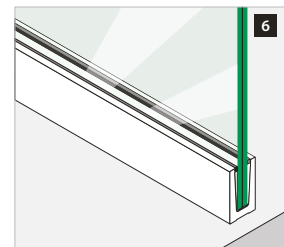
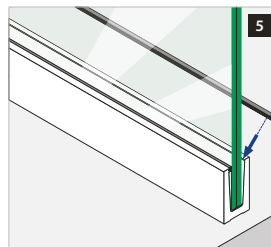
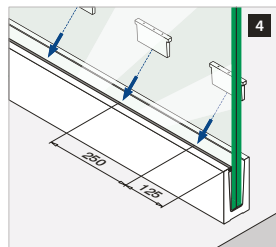
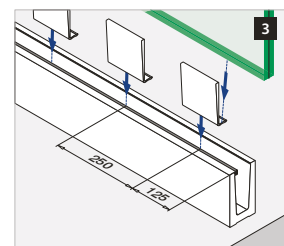
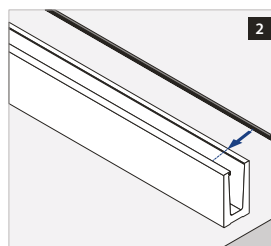
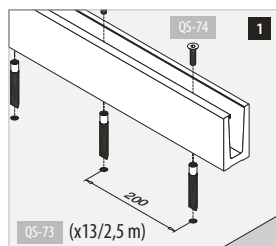
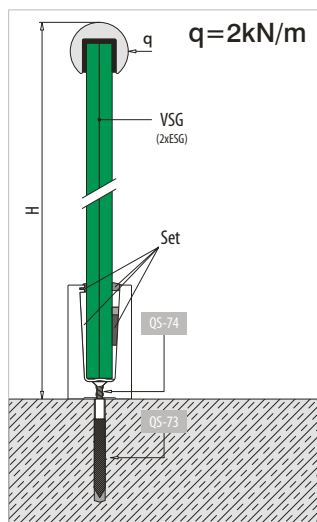

VSG (2x ESG): Laminated glass from toughened glass
 ESG : Toughened glass

Please note for specifications such as mounting and glass dimension measurements, see the respective certificates.

EASY GLASS® 3KN - Connectors, top mount

Inner corner

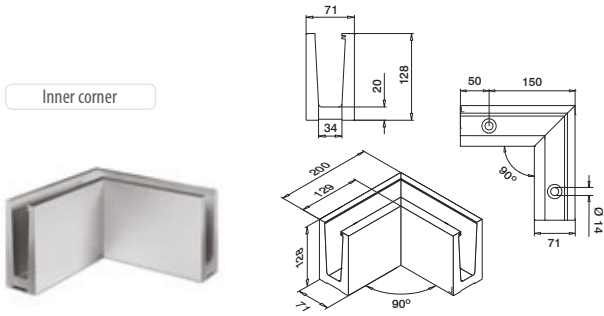

MOD 6313

Aluminium	Stainless steel effect		
OUTDOOR			
16.6313.008.18	QS-73 307 / QS-74 303		1



Outer corner

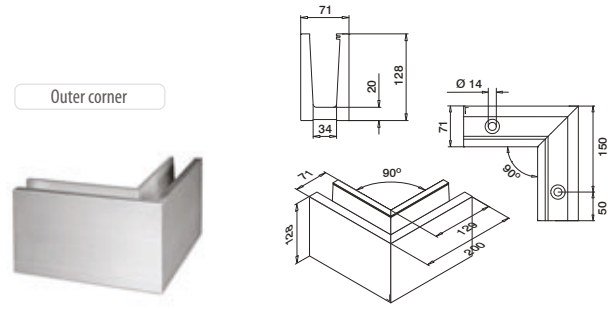

MOD 6314

Aluminium	Stainless steel effect		
OUTDOOR			
16.6314.008.18	QS-73 307 / QS-74 303		1



EASY GLASS® 3KN - Cladding, top mount

Cladding frontside



MOD 6920

304		
INDOOR		
13.6920.008.12	L = 2500 mm	

Cladding backside



MOD 6921

304	T	
INDOOR		
13.6921.198.12	19	L = 2500 mm
13.6921.218.12	20,76 - 21,52	L = 2500 mm
13.6921.258.12	24,76 - 25,52	L = 2500 mm
13.6921.328.12	31,52	L = 2500 mm

Q-INFO

MOD 6908

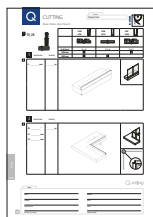

We can cut this article for you based on your specifications for length and required angles. Contact us for details, or see the 'Cutting' information on page 344, 345, 346, 350.

Q-INFO

MOD 6920 / 6921

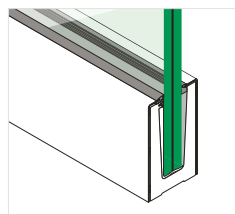
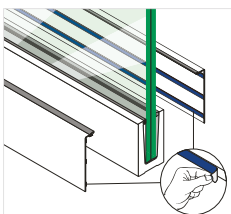

Q-INFO

MOD 6313 / 6314

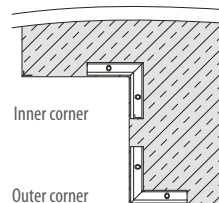

Q-INFO



Q-23
Q-cleaner
300 ml
19.0601.000.00

EASY GLASS® 3KN - End fittings, top mount

Use without cladding

Left + right applicable

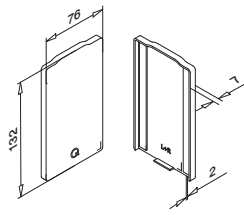

MOD 6734

Aluminium Stainless steel effect

OUTDOOR

16.6734.008.18



1

Use with stainless steel cladding

Left + right applicable

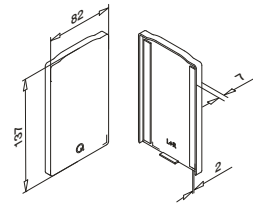

MOD 6734

Zinc Stainless steel effect

OUTDOOR

10.6734.008.20



1

Use without cladding

For stairs

Left + right applicable

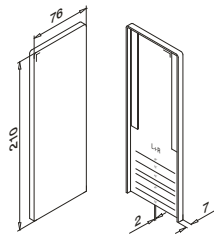

MOD 6736

Aluminium Stainless steel effect

OUTDOOR

16.6736.008.18



1



Q-INFO MOD 6734

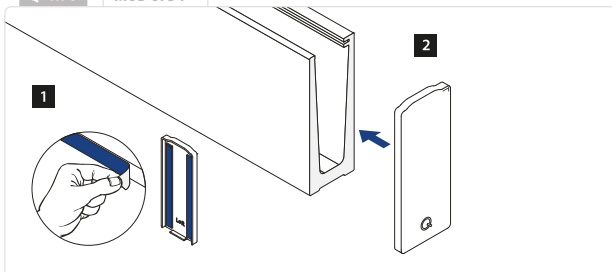

Q-INFO MOD 6736

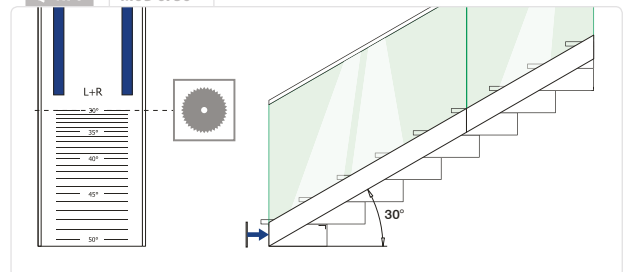

EASY GLASS® 3KN - Mounting plates, top mount

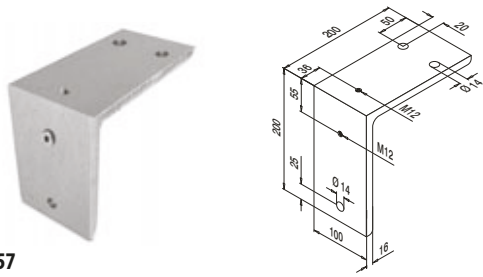

MOD 6957

Zinc-plated

19.6957.200.15	QS-507 307	1
----------------	------------	---



EASY GLASS® 3KN - Drainage profiles, top mount

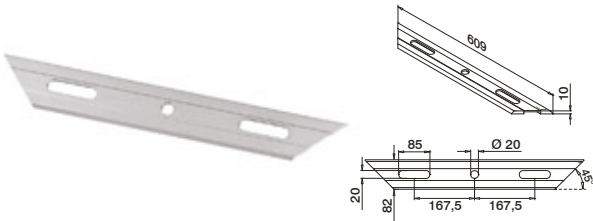

MOD 6948

Aluminium

Stainless steel effect

OUTDOOR

16.6948.008.18		4
----------------	--	---

International Design Model Protection

Q-INFO MOD 6957

3kN

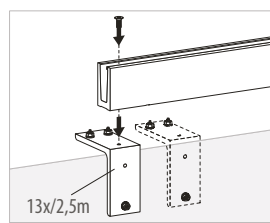
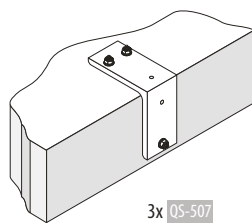
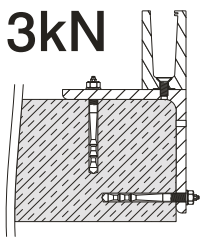

Q-INFO MOD 6948

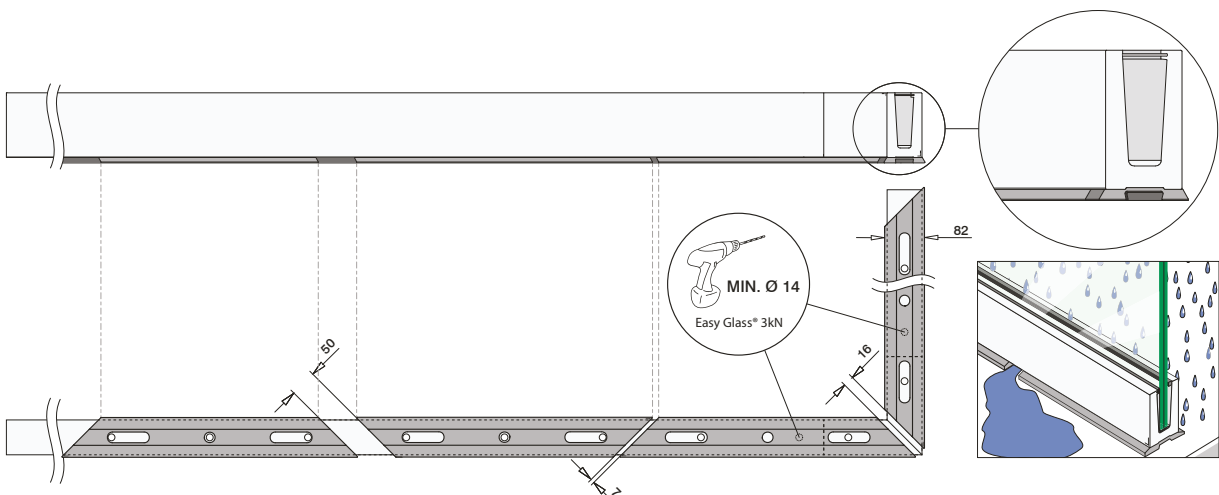

EASY GLASS® 3KN - Base shoe, fascia mount

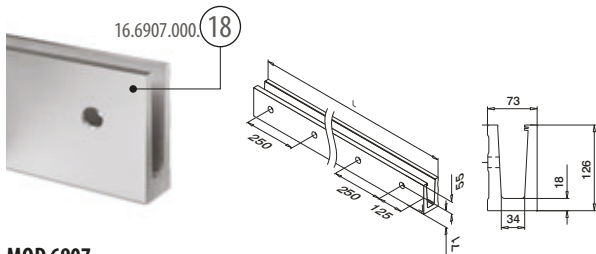

MOD 6907

Aluminium	Stainless steel effect
OUTDOOR	
16.6907.000.18	QS-73 307 / QS-74 303 L = 2500 mm



Accessories

EASY GLASS® - Multitool



MOD 6920

Accessories	Q	
19.6920.000.00	Q-71	1

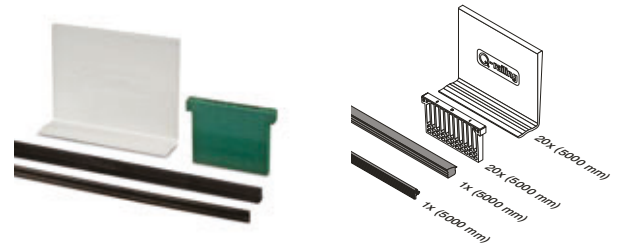

MOD 6907

Accessories		
	T	
19.6907.919.00	19	L = 5000 mm
19.6907.921.00	20,76 (10 - 0,76 - 10)	L = 5000 mm
19.6907.922.00	21,52 (10 - 1,52 - 10)	L = 5000 mm
19.6907.924.00	24,76 (12 - 0,76 - 12)	L = 5000 mm
19.6907.925.00	25	L = 5000 mm
19.6907.926.00	25,52 (12 - 1,52 - 12)	L = 5000 mm
19.6907.932.00	31,52 (15 - 1,52 - 15)	L = 5000 mm
19.6907.519.00	19	L = 25 m
19.6907.521.00	20,76 (10 - 0,76 - 10)	L = 25 m
19.6907.522.00	21,52 (10 - 1,52 - 10)	L = 25 m
19.6907.524.00	24,76 (12 - 0,76 - 12)	L = 25 m
19.6907.525.00	25	L = 25 m
19.6907.526.00	25,52 (12 - 1,52 - 12)	L = 25 m
19.6907.532.00	31,52 (15 - 1,52 - 15)	L = 25 m

Safety Wedge System:
Glass is being clamped. Drilling is not necessary.

International Design Model Protection

EASY GLASS® 3KN - Connectors, fascia mount

Inner corner

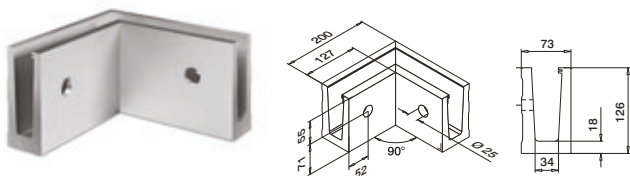

MOD 6315

Aluminium	Stainless steel effect
OUTDOOR	
16.6315.007.18	QS-73 307 / QS-74 303 1



Outer corner

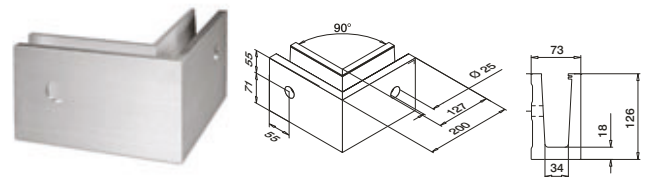

MOD 6316

Aluminium	Stainless steel effect
OUTDOOR	
16.6316.007.18	QS-73 307 / QS-74 303 1



Q-INFO MOD 6315 / 6316

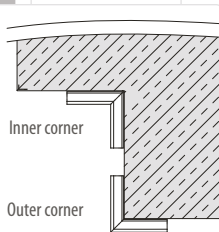

Q-INFO MOD 6907 / 6315 / 6316

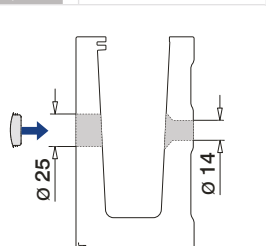

Q-INFO MOD 6907

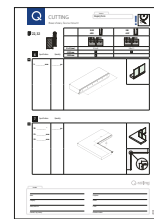

We can cut this article for you based on your specifications for length and required angles. Contact us for details, or see the 'Cutting' information on page 347, 348, 349, 351.

EASY GLASS® 3KN - Cladding, fascia mount

Cladding frontside



MOD 6920

304

INDOOR

13.6920.007.12

L = 2500 mm

Cladding frontside



MOD 6920

Aluminium

Stainless steel effect

OUTDOOR

16.6920.007.18

L = 2500 mm

EASY GLASS® 3KN - End fittings, fascia mount

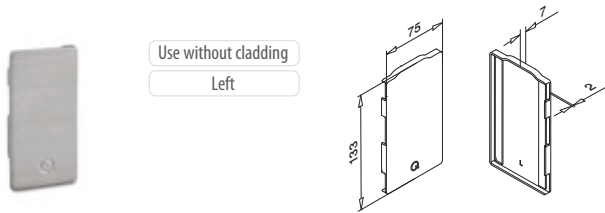

Use without cladding

Left

MOD: 6734

Aluminium

Stainless steel effect

OUTDOOR

16.6734.007.18

1

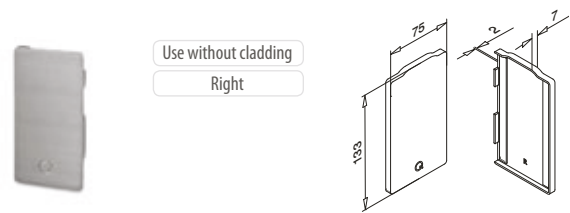

Use without cladding

Right

MOD: 6735

Aluminium

Stainless steel effect

OUTDOOR

16.6735.007.18

1

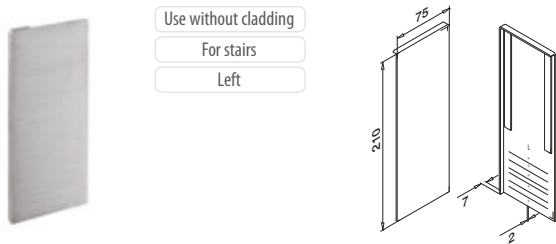

Use without cladding

For stairs

Left

MOD 6736

Aluminium

Stainless steel effect

OUTDOOR

16.6736.007.18

1

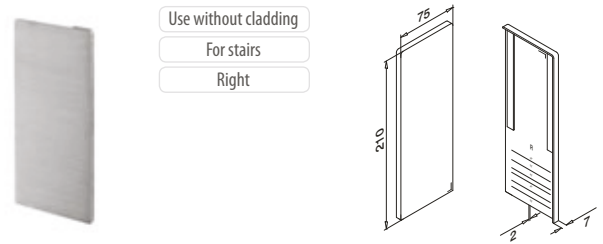

Use without cladding

For stairs

Right

MOD 6737

Aluminium

Stainless steel effect

OUTDOOR

16.6737.007.18

1



Q-INFO MOD 6734 / 6735

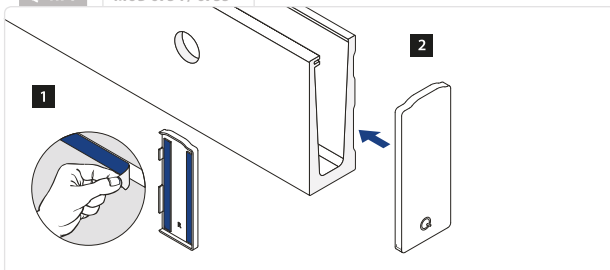

Q-INFO MOD 6736 / 6737

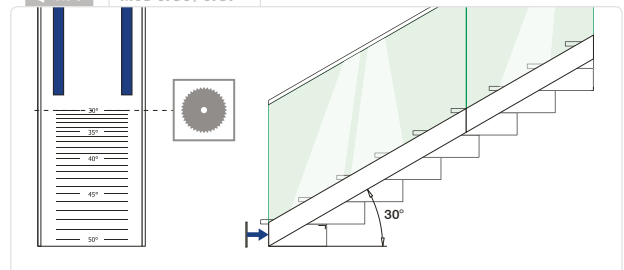

EASY GLASS® 3KN - End fittings, fascia mount



For stainless steel cladding
Left

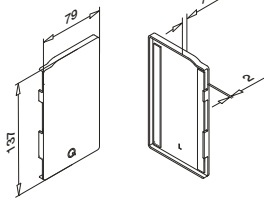

MOD 6734

Zinc	Stainless steel effect
OUTDOOR	
10.6734.107.20	1



For stainless steel cladding
Right

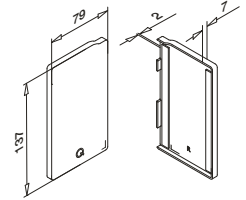

MOD 6735

Zinc	Stainless steel effect
OUTDOOR	
10.6735.107.20	1



For aluminium cladding
Left

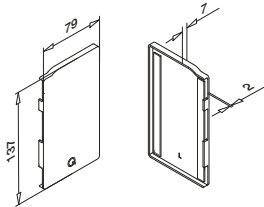

MOD 6734

Aluminium	Stainless steel effect
OUTDOOR	
16.6734.107.18	1



For aluminium cladding
Right

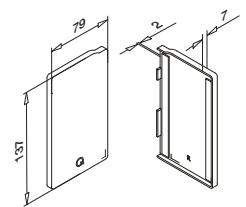

MOD 6735

Aluminium	Stainless steel effect
OUTDOOR	
16.6735.107.18	1

EASY GLASS® 3KN - Cover caps, fascia mount

Use without cladding

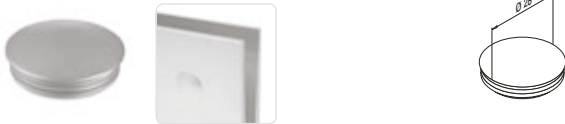

MOD 6922

ABS plastic	
OUTDOOR	
24.6922.007.36	10

Q-INFO

MOD 6922

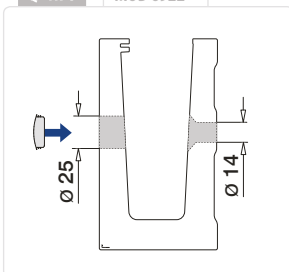

Q-INFO

MOD 6734 / 6735

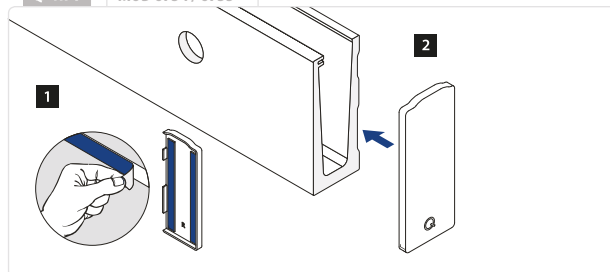

EASY GLASS® 3KN - Mounting plates, fascia mount

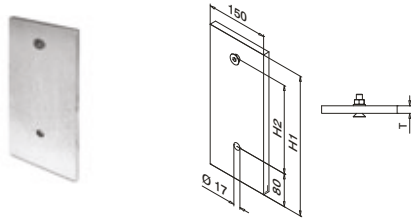

MOD 6954

Zinc-plated		H1	H2	T	
19.6954.250.15	QS-507 307	250	120	20	1
19.6954.340.15	QS-507 307	340	210	20	1

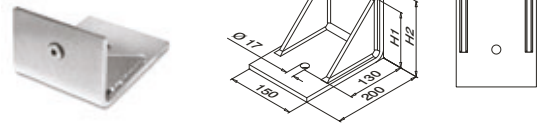

MOD 6955

Zinc-plated		H1	H2	T	
19.6955.175.15	QS-507 307	130	175	15	1

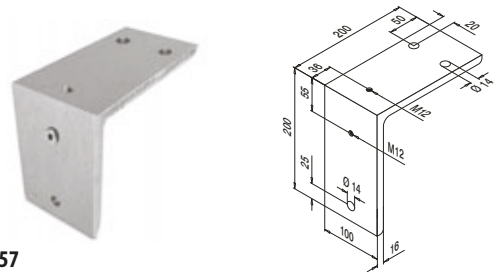

MOD 6957

Zinc-plated		H1	H2	T	
19.6957.200.15	QS-507 307				1



Q-INFO MOD 6957

3kN

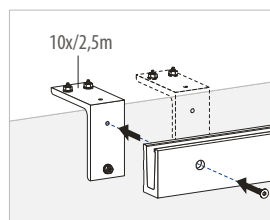
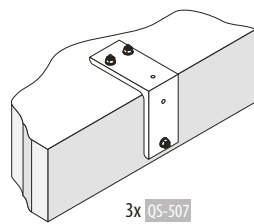
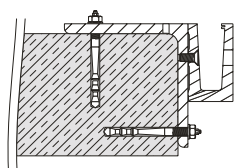

Q-INFO MOD 6954 / 6955

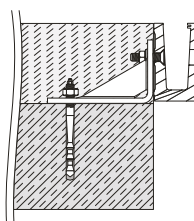
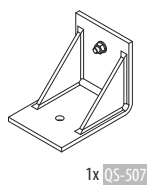
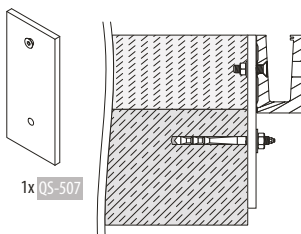

Q-INFO

MOD 6907

Possible applications

Mounting, fascia mount

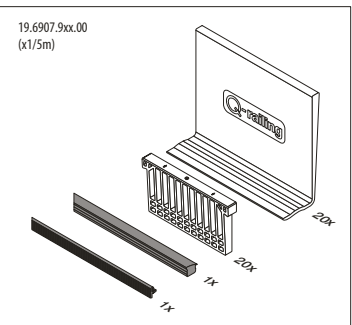
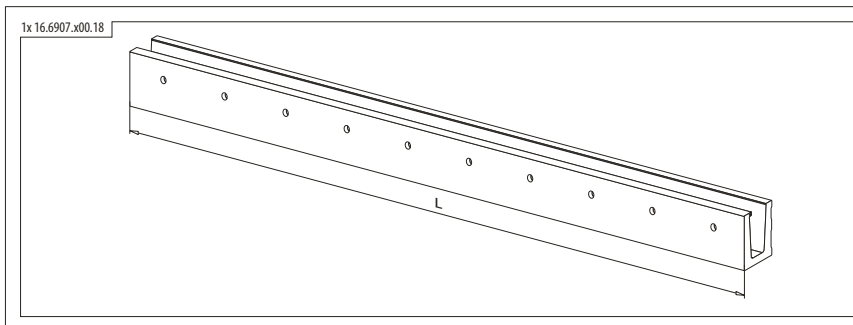
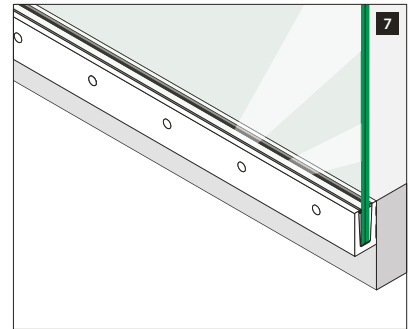
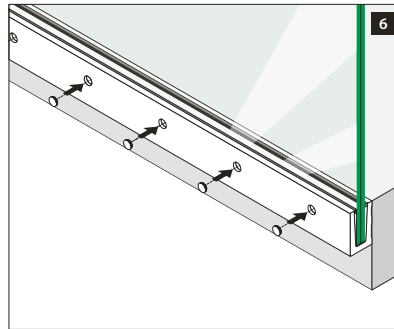
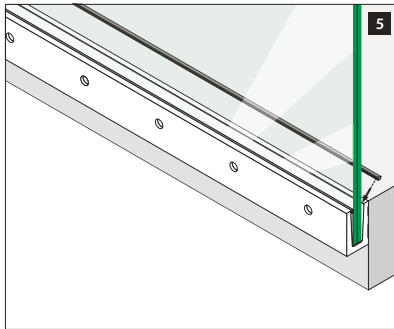
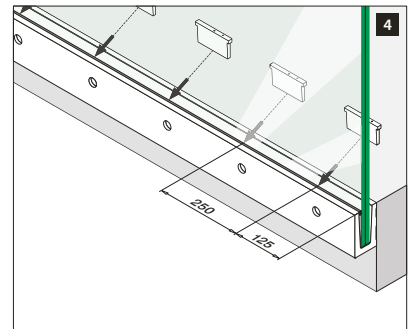
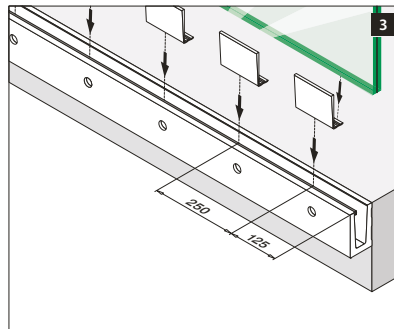
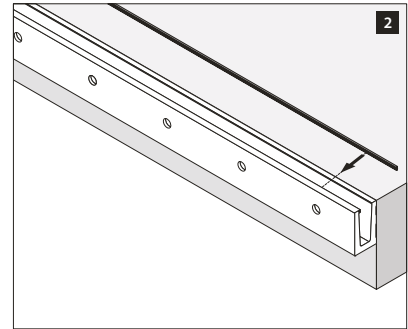
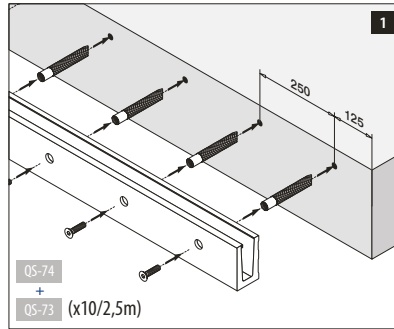
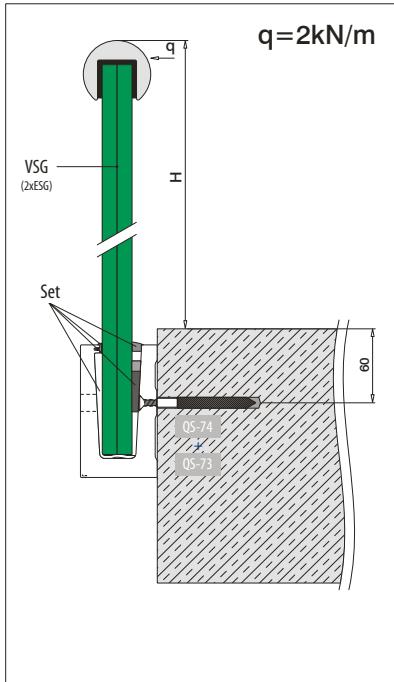

VSG (2x ESG): Laminated glass from toughened glass
ESG : Toughened glass

Please note for specifications such as mounting and glass dimension measurements, see the respective certificates.

For more information, please visit our website: www.q-railing.com



Q-INFO

MOD 6921

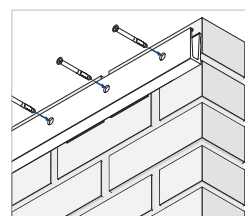
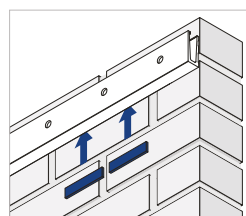



DESIGN
product

Q-railing®



Top mount

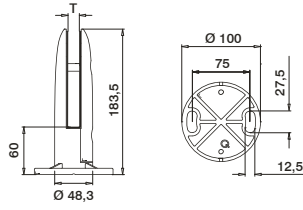

MOD 61

316				
OUTDOOR		T	QS-519	309
14.6112.000.12		12	QS-519	309
14.6113.000.12	12,76 (6 - 0,76 - 6)		QS-519	309
14.6114.000.12	13,52 (6 - 1,52 - 6)		QS-519	309
14.6115.000.12		15	QS-519	309
14.6117.000.12	16,76 (8 - 0,76 - 8)		QS-519	309
14.6118.000.12	17,52 (8 - 1,52 - 8)		QS-519	309



Infloor

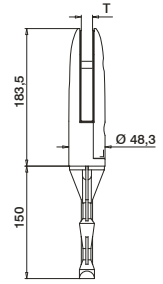

MOD 61

316				
OUTDOOR		T		
14.6112.100.12		12		1
14.6113.100.12	12,76 (6 - 0,76 - 6)			1
14.6114.100.12	13,52 (6 - 1,52 - 6)			1
14.6115.100.12		15		1
14.6117.100.12	16,76 (8 - 0,76 - 8)			1
14.6118.100.12	17,52 (8 - 1,52 - 8)			1

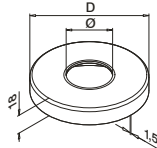

MOD 0512

316				
OUTDOOR		Ø	D	
14.0512.048.12		48,3	Ø 105	2

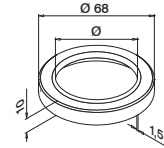

MOD 0517

316				
OUTDOOR		Ø		
14.0517.048.12		48,3		2

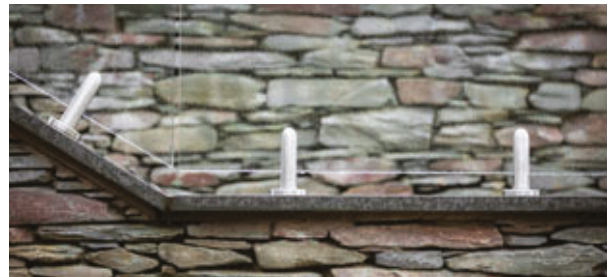

Q-INFO MOD 611x.000

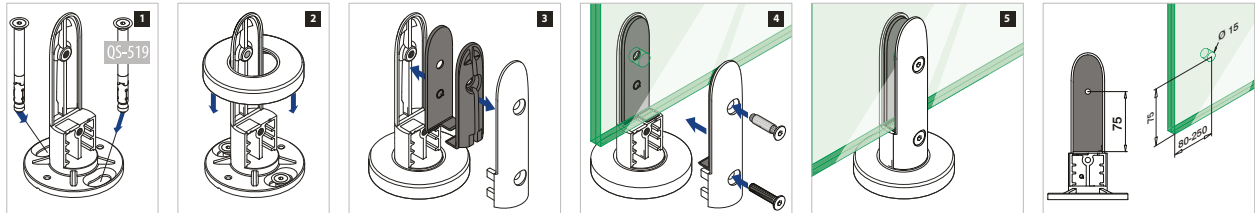

Q-INFO MOD 611x.100

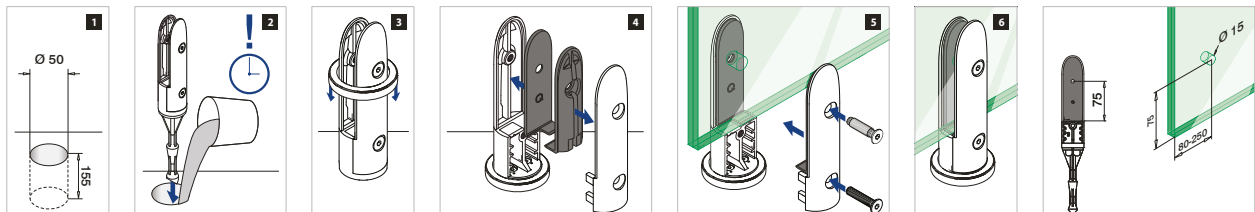



Top mount

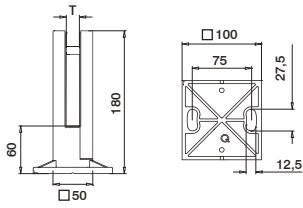

MOD 62

316

OUTDOOR	T		
14.6212.000.12	12	QS-519	309 1
14.6213.000.12	12,76 (6 - 0,76 - 6)	QS-519	309 1
14.6214.000.12	13,52 (6 - 1,52 - 6)	QS-519	309 1
14.6215.000.12	15	QS-519	309 1
14.6217.000.12	16,76 (8 - 0,76 - 8)	QS-519	309 1
14.6218.000.12	17,52 (8 - 1,52 - 8)	QS-519	309 1



Infloor

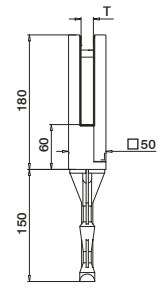

MOD 62

316

OUTDOOR	T		
14.6212.100.12	12		1
14.6213.100.12	12,76 (6 - 0,76 - 6)		1
14.6214.100.12	13,52 (6 - 1,52 - 6)		1
14.6215.100.12	15		1
14.6217.100.12	16,76 (8 - 0,76 - 8)		1
14.6218.100.12	17,52 (8 - 1,52 - 8)		1

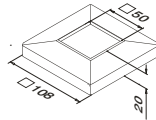
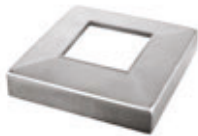

MOD 4511

316

OUTDOOR		
14.4511.050.12	2	

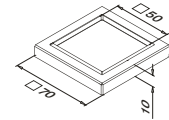

MOD 4517

316

OUTDOOR		
14.4517.050.12	2	



Q-INFO

MOD 621x.000

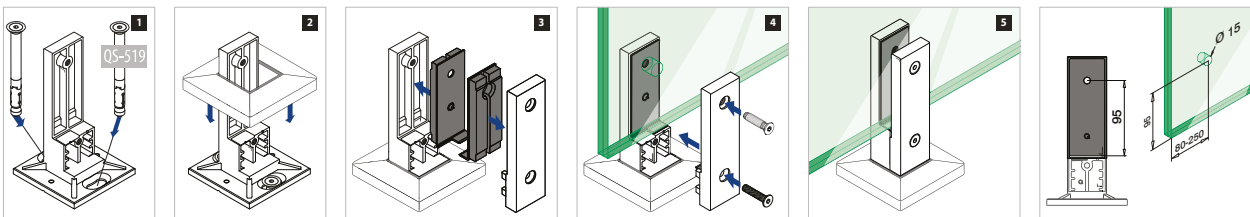

Q-INFO

MOD 621x.100

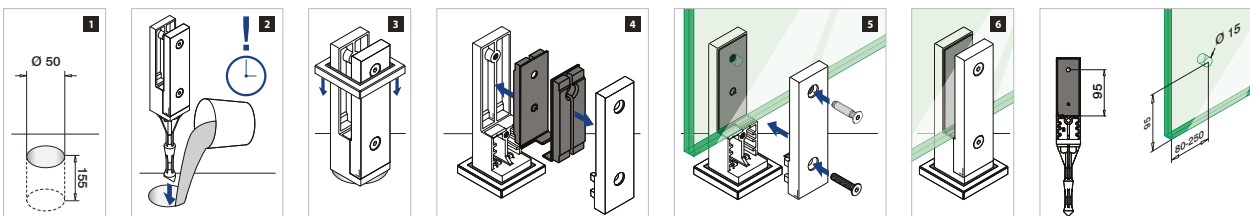

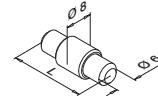
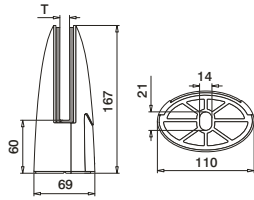

Security pins for glass clamps, optional use for model 6000

MOD 5015

Accessories	For MOD	L	
19.5015.030.00	6000	30	4

MOD 6000

316	T		
OUTDOOR			
14.6012.000.12	12	QS-60 307	1
14.6013.000.12	12,76 (6 - 0,76 - 6)	QS-60 307	1
14.6014.000.12	13,52 (6 - 1,52 - 6)	QS-60 307	1
14.6015.000.12	15	QS-60 307	1
14.6017.000.12	16,76 (8 - 0,76 - 8)	QS-60 307	1
14.6018.000.12	17,52 (8 - 1,52 - 8)	QS-60 307	1



International Design Model Protection

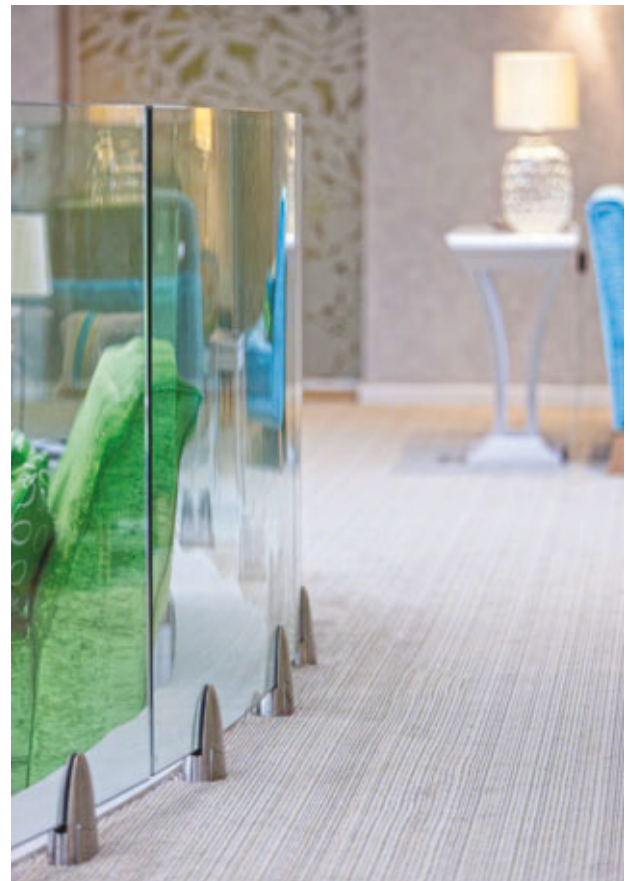

Please order security pins and fixing bolts separately.

Q-INFO MOD 5015

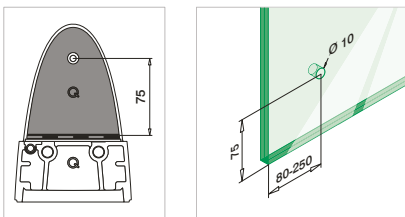

Q-INFO MOD 6000

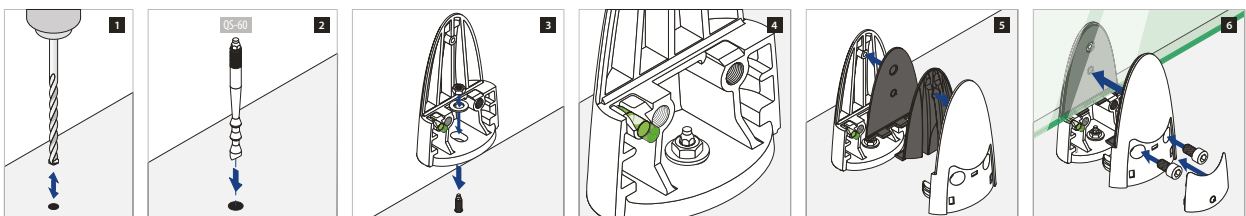

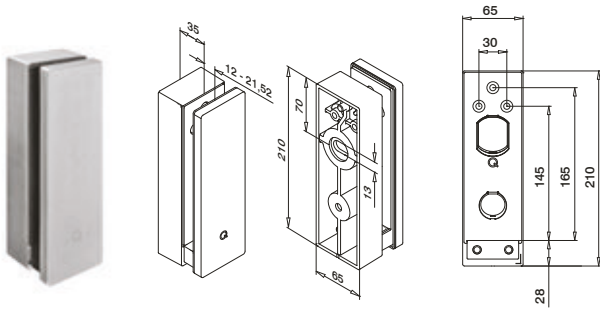

MOD 0763

304		
INDOOR		
13.0763.000.12	QS-61	307
		1
316		
OUTDOOR		
14.0763.000.12	QS-60	307
		1



International Design Model Protection

For more information, please visit our website: www.q-railing.com

Q-INFO

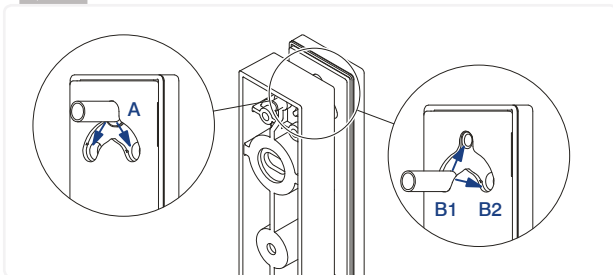

Q-INFO

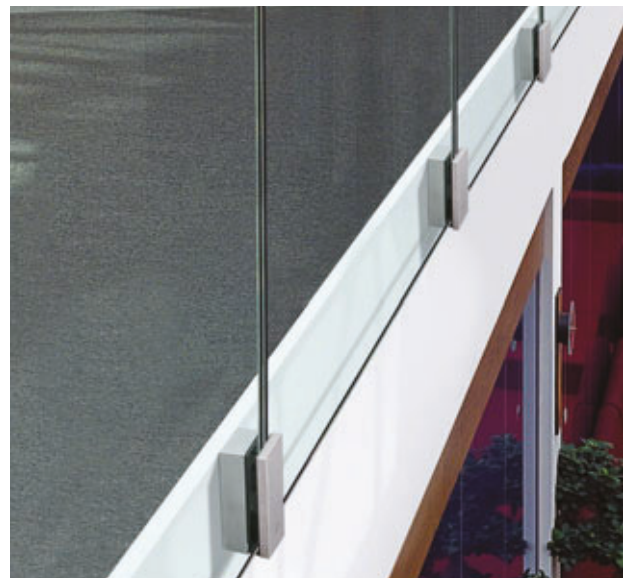
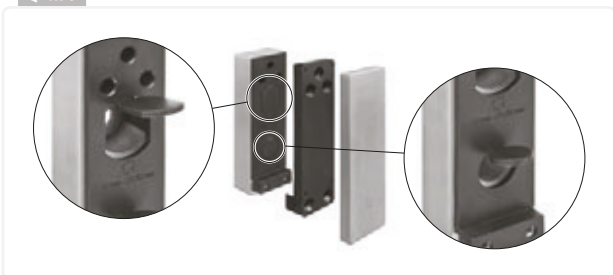

Q-INFO

Possible applications

Fascia mount

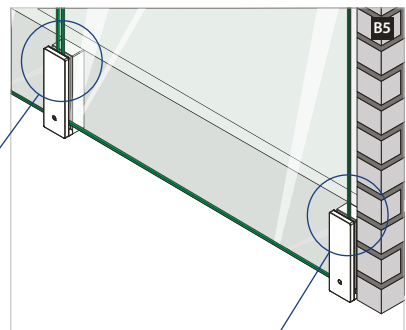
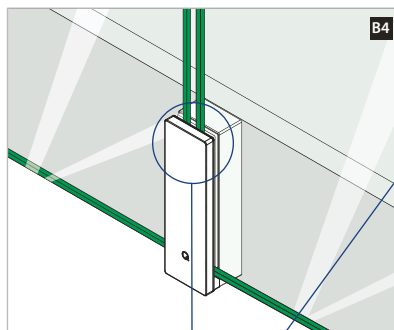
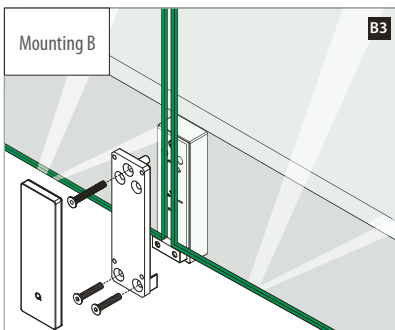
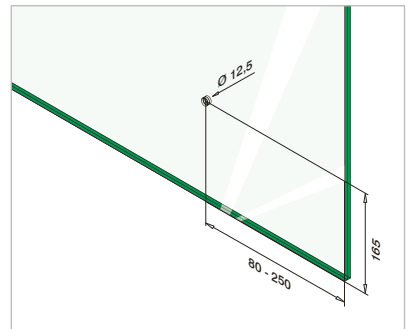
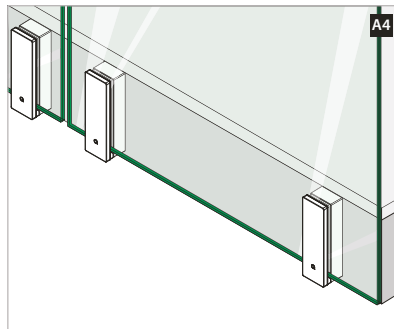
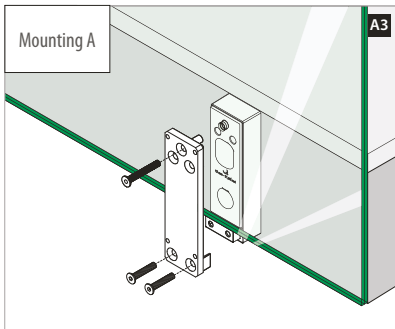
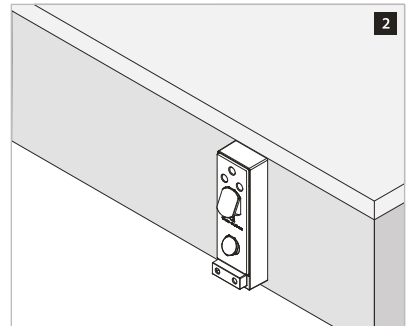
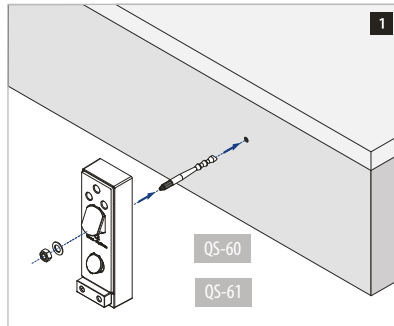
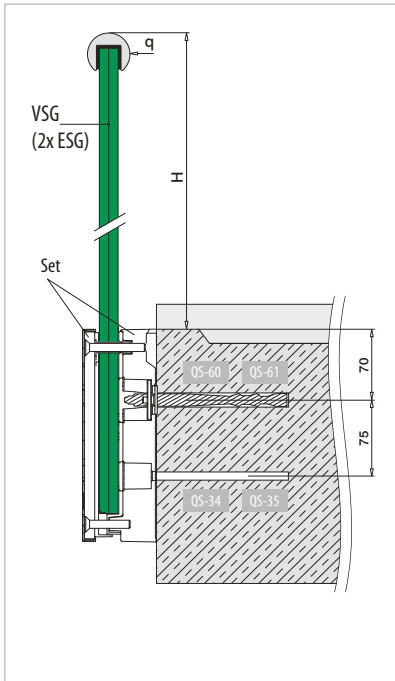

VSG (2x ESG): Laminated glass from toughened glass
 ESG : Toughened glass

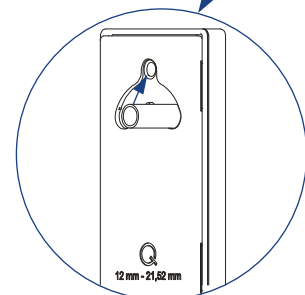
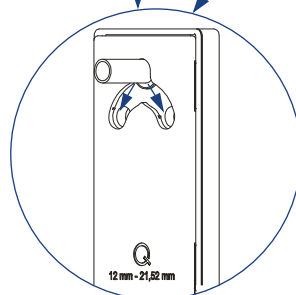



DESIGN
product

Q-railing®

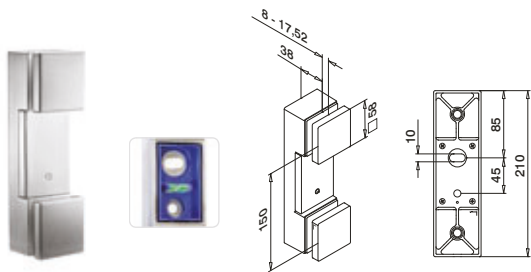

MOD 4762

316

OUTDOOR

14.4762.000.12

QS-64 306

1



International Design Model Protection

Q-INFO

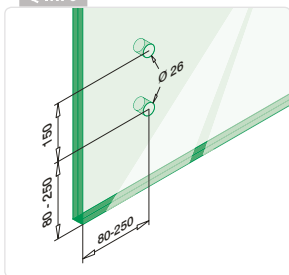

Q-INFO

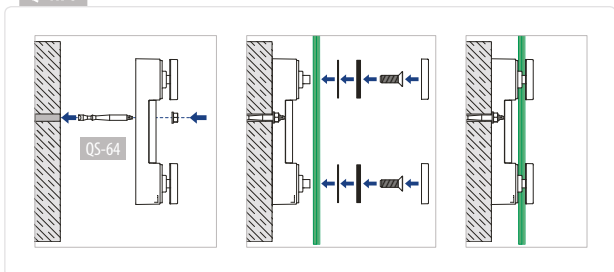

Q-INFO

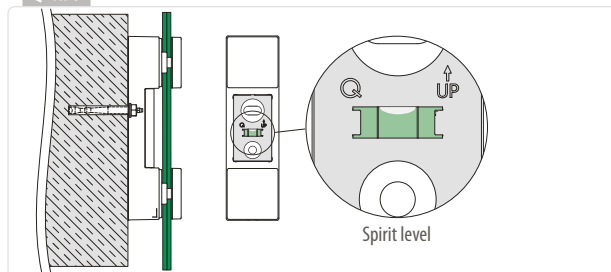

Angle NOT adjustable

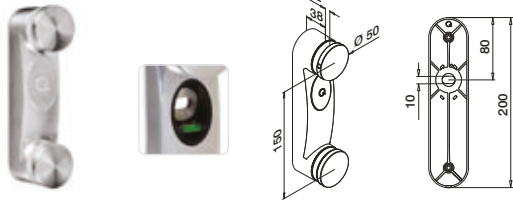

MOD 0762

304		
INDOOR		
13.0762.000.12	QS-63 307	1
316		
OUTDOOR		
14.0762.000.12	QS-62 307	1



International Design Model Protection

Angle NOT adjustable

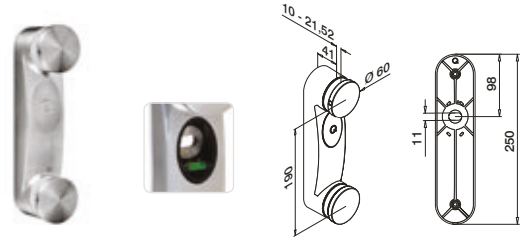

MOD 0761

304		
INDOOR		
13.0761.000.12	QS-75 307	1
316		
OUTDOOR		
14.0761.000.12	QS-75 307	1



International Design Model Protection

Angle NOT adjustable

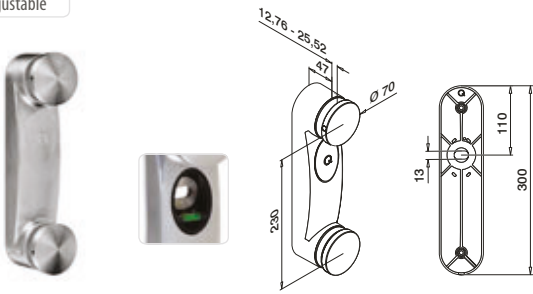

MOD 0760

304		
INDOOR		
13.0760.000.12	QS-61 307	1
316		
OUTDOOR		
14.0760.000.12	QS-60 307	1



International Design Model Protection

Q-INFO

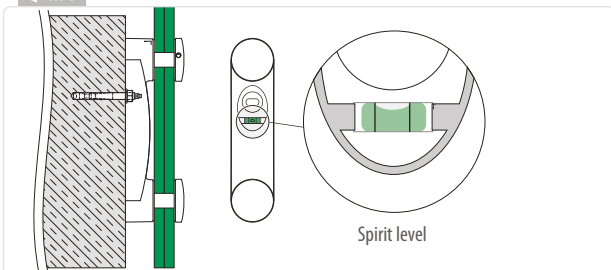

Q-INFO

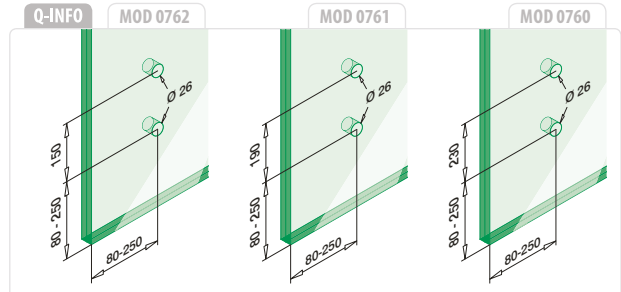

Angle adjustable

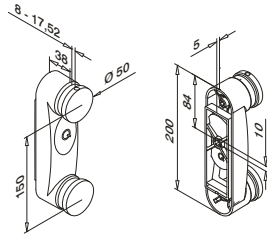

MOD 0766

304		
INDOOR		
13.0766.000.12	QS-528 307 / QS-29 303	1
316		
OUTDOOR		
14.0766.000.12	QS-529 307 / QS-30 303	1



International Design Model Protection

Angle adjustable

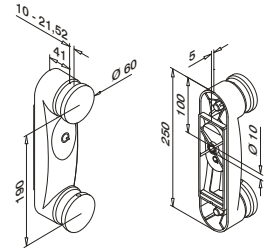

MOD 0765

304		
INDOOR		
13.0765.000.12	QS-521 307 / QS-67 303	1
316		
OUTDOOR		
14.0765.000.12	QS-520 307 / QS-68 303	1



International Design Model Protection

Angle adjustable

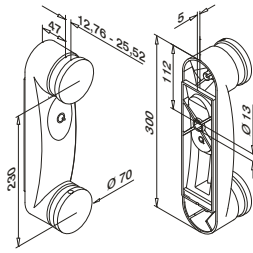

MOD 0764

304		
INDOOR		
13.0764.000.12	QS-505 307 / QS-551 303	1
316		
OUTDOOR		
14.0764.000.12	QS-73 307 / QS-552 303	1



International Design Model Protection

Q-INFO

MOD 0766

MOD 0765

MOD 0764

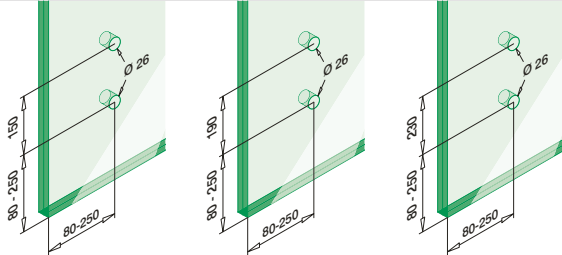

Q-INFO

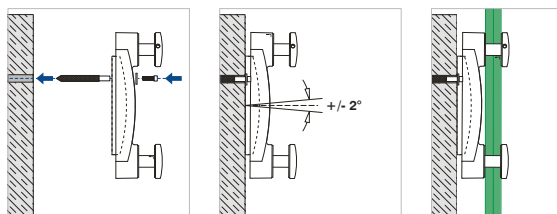

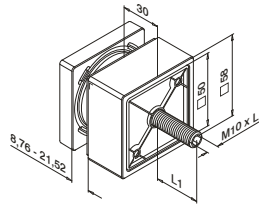

MOD 4747

316

OUTDOOR	L	L1	
14.4747.300.12	80	17	2



DESIGN product

International Design Model Protection

Q-INFO

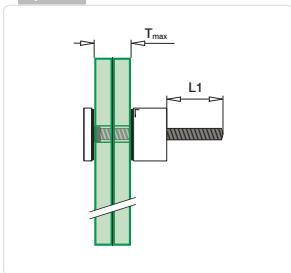

Q-INFO

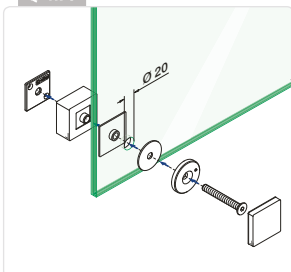

Q-INFO

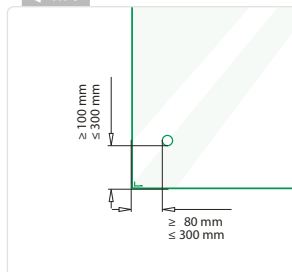

Flat - glass

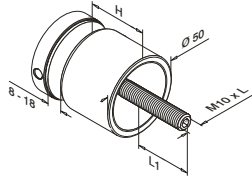

MOD 0747

304				
INDOOR	H	L	L1	
13.0747.000.12	10	50	10	2
13.0747.300.12	30	80	20	2
13.0747.400.12	40	80	10	2
13.0747.500.12	50	90	10	2

316				
OUTDOOR	H	L	L1	
14.0747.000.12	10	50	10	2
14.0747.300.12	30	80	20	2
14.0747.400.12	40	80	10	2
14.0747.500.12	50	90	10	2

Zinc	Raw				
INDOOR		H	L	L1	
10.0747.000.00		10	50	10	2
Zinc	Stainless steel effect				
OUTDOOR		H	L	L1	
10.0747.000.20		10	50	10	2



Flat - glass

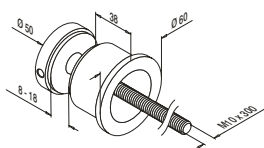

MOD 0748

316		
OUTDOOR		
14.0748.350.12	2	



Flat - glass

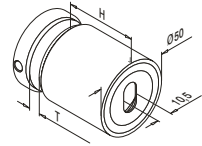

MOD 0749

304						
INDOOR	H	T				
13.0749.300.12	30	8 - 18	QS-521	307 / QS-532	303	2
13.0749.400.12	40	8 - 21,52	QS-521	307 / QS-532	303	2
13.0749.500.12	50	8 - 21,52	QS-521	307 / QS-532	303	2

316						
OUTDOOR	H	T				
14.0749.300.12	30	8 - 18	QS-520	307 / QS-533	303	2
14.0749.400.12	40	8 - 21,52	QS-520	307 / QS-533	303	2
14.0749.500.12	50	8 - 21,52	QS-520	307 / QS-533	303	2



Infills

SATIN

Glass connectors

Glass - glass

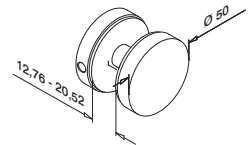

MOD 0742

304		
INDOOR		
13.0742.050.12	2	
316		
OUTDOOR		
14.0742.050.12	2	



Q-INFO

MOD 0747

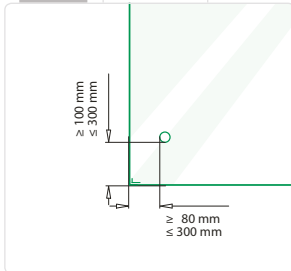

Q-INFO

MOD 0747

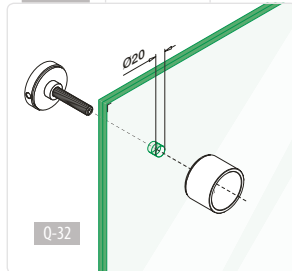

Q-INFO

MOD 0748.350

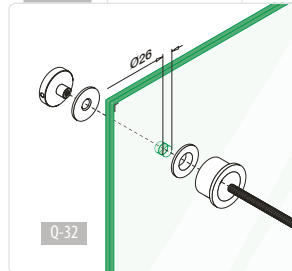

Q-INFO

MOD 0742

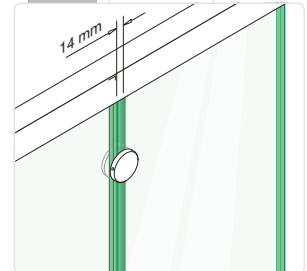

Q-INFO

MOD 0749

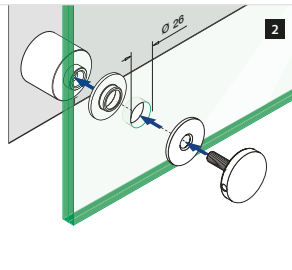
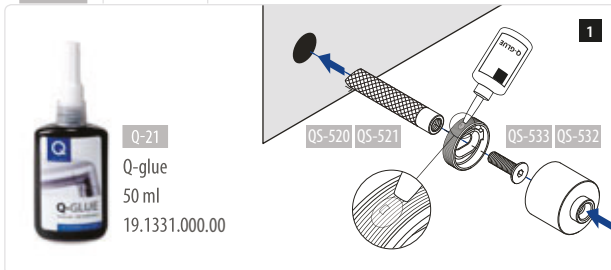



Flat - glass

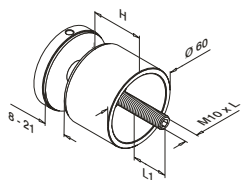

MOD 0745

304				
INDOOR	H	L	L1	
13.0745.300.12	30	90	27	2
13.0745.400.12	40	100	27	2
13.0745.500.12	50	110	27	2
316				
OUTDOOR	H	L	L1	
14.0745.300.12	30	90	27	2
14.0745.400.12	40	100	27	2
14.0745.500.12	50	110	27	2



Flat - glass

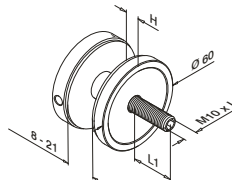

MOD 0745

304				
INDOOR	H	L	L1	
13.0745.000.12	10	70	27	2
316				
OUTDOOR	H	L	L1	
14.0745.000.12	10	70	27	2



Flat - glass

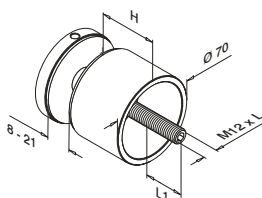

MOD 0748

304				
INDOOR	H	L	L1	
13.0748.300.12	30	90	28	2
13.0748.400.12	40	100	28	2
13.0748.500.12	50	110	28	2
316				
OUTDOOR	H	L	L1	
14.0748.300.12	30	90	28	2
14.0748.400.12	40	100	28	2
14.0748.500.12	50	110	28	2



Flat - glass

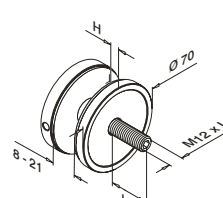

MOD 0748

304				
INDOOR	H	L	L1	
13.0748.000.12	10	70	28	2
316				
OUTDOOR	H	L	L1	
14.0748.000.12	10	70	28	2



Q-INFO MOD 0748.x00

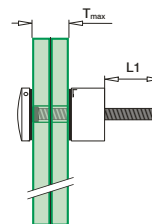

Q-INFO 0745.000

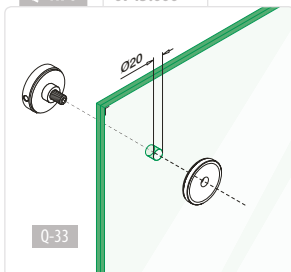

Q-33

Q-INFO 0745.x00

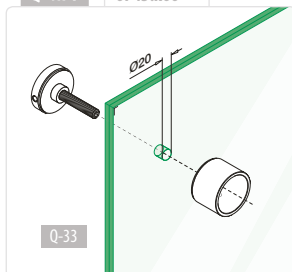

Q-33

Q-INFO 0748.000

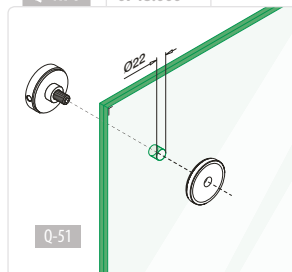

Q-51

Q-INFO 0748.x00

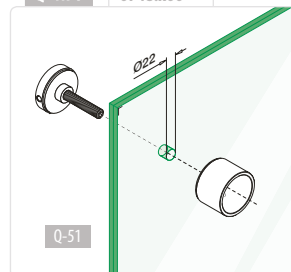

Q-51

TEMPERED LAMINATED GLASS · TEMPERED LAMINATED GLASS
CE
Q-GLASS
TEMPERED LAMINATED GLASS

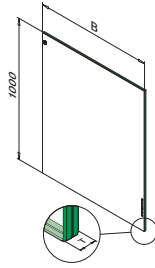
MOD 10 - VSG (2x ESG)* - H=1000 mm

Glass		
OUTDOOR	B	T
50.1001.082.00	100	16,76 (8 - 0,76 - 8)
50.1002.082.00	200	16,76 (8 - 0,76 - 8)
50.1003.082.00	300	16,76 (8 - 0,76 - 8)
50.1004.082.00	400	16,76 (8 - 0,76 - 8)
50.1005.082.00	500	16,76 (8 - 0,76 - 8)
50.1006.082.00	600	16,76 (8 - 0,76 - 8)
50.1007.082.00	700	16,76 (8 - 0,76 - 8)
50.1008.082.00	800	16,76 (8 - 0,76 - 8)
50.1009.082.00	900	16,76 (8 - 0,76 - 8)
50.1009.582.00	950	16,76 (8 - 0,76 - 8)
50.1010.082.00	1000	16,76 (8 - 0,76 - 8)
50.1110.082.00	1100	16,76 (8 - 0,76 - 8)
50.1210.082.00	1200	16,76 (8 - 0,76 - 8)

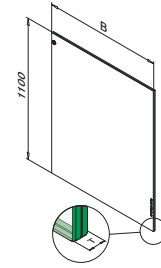
MOD 11 - VSG (2x ESG)* - H=1100 mm

Glass		
OUTDOOR	B	T
50.1101.082.00	100	16,76 (8 - 0,76 - 8)
50.1102.082.00	200	16,76 (8 - 0,76 - 8)
50.1103.082.00	300	16,76 (8 - 0,76 - 8)
50.1104.082.00	400	16,76 (8 - 0,76 - 8)
50.1105.082.00	500	16,76 (8 - 0,76 - 8)
50.1106.082.00	600	16,76 (8 - 0,76 - 8)
50.1107.082.00	700	16,76 (8 - 0,76 - 8)
50.1108.082.00	800	16,76 (8 - 0,76 - 8)
50.1109.082.00	900	16,76 (8 - 0,76 - 8)
50.1109.582.00	950	16,76 (8 - 0,76 - 8)
50.1110.082.00	1000	16,76 (8 - 0,76 - 8)

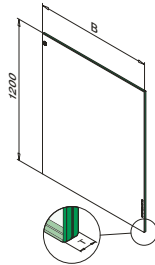
MOD 12 - VSG (2x ESG)* - H=1200 mm

Glass		
OUTDOOR	B	T
50.1201.082.00	100	16,76 (8 - 0,76 - 8)
50.1202.082.00	200	16,76 (8 - 0,76 - 8)
50.1203.082.00	300	16,76 (8 - 0,76 - 8)
50.1204.082.00	400	16,76 (8 - 0,76 - 8)
50.1205.082.00	500	16,76 (8 - 0,76 - 8)
50.1206.082.00	600	16,76 (8 - 0,76 - 8)
50.1207.082.00	700	16,76 (8 - 0,76 - 8)
50.1208.082.00	800	16,76 (8 - 0,76 - 8)
50.1209.082.00	900	16,76 (8 - 0,76 - 8)
50.1209.582.00	950	16,76 (8 - 0,76 - 8)
50.1210.082.00	1000	16,76 (8 - 0,76 - 8)



* VSG (2x ESG) : Laminated glass from toughened glass

Q-INFO
Calculation

$$H \text{ (m)} \times B \text{ (m)} \times 2,5 \times T_g \text{ (mm)} = \text{kg}$$

Example	H	B	T
	1,1 m	1,0 m	16 mm
	$1,1 \times 1,0 \times 2,5 \times 16 = 44,00 \text{ kg}$		

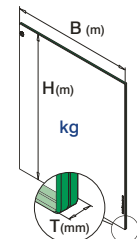
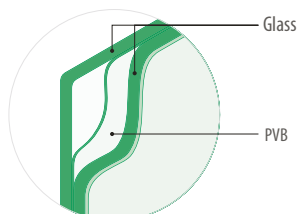
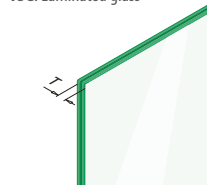
Q-INFO
VSG: Laminated glass

- Smooth
- Rounded edge
- Polished
- Rounded corners



EASY GLASS® - U-profiles and rubber inlays, rectangular

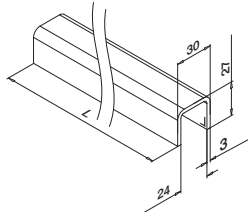

MOD 6940

316

OUTDOOR

14.6940.030.12

L = 5000 mm

NEW

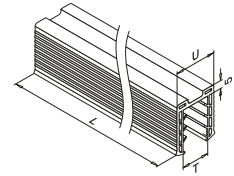

MOD 50

Accessories

	U	T	Icon
19.5042.008.00	24	8 - 11	L = 5000 mm
19.5042.011.00	24	11,5 - 13,5	L = 5000 mm
19.5042.015.00	24	15	L = 5000 mm
19.5042.016.00	24	16 - 17,5	L = 5000 mm
19.5042.019.00	24	19	L = 5000 mm
19.5042.022.00	24	20 - 21,5	L = 5000 mm

EASY GLASS® - U-profiles, rectangular

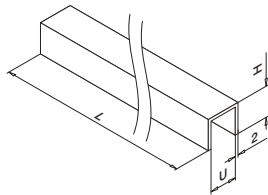

MOD 6945 / 6940

Aluminium

Stainless steel effect

OUTDOOR	U	T	H	Icon
16.6945.013.18	13,25	12,76	15	L = 2500 mm
16.6940.013.18	13,25	12,76	15	L = 5000 mm
16.6945.018.18	18	16,76 - 17,52	20	L = 2500 mm
16.6940.018.18	18	16,76 - 17,52	20	L = 5000 mm
16.6945.022.18	22	21,52	20	L = 2500 mm
16.6940.022.18	22	21,52	20	L = 5000 mm



Q-INFO

MOD 6940.013/018/022

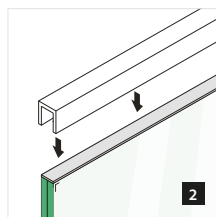
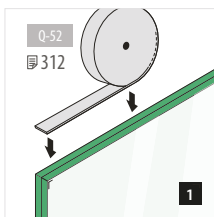

Q-INFO

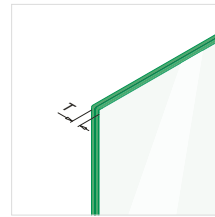

Q-INFO

MOD 6940.030

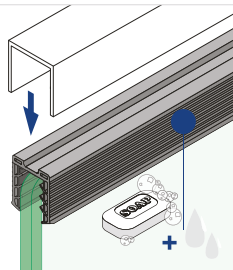
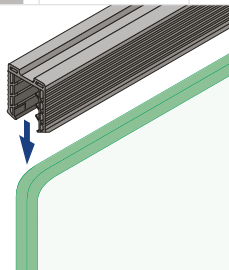

Q-24
Q-seal
310 ml
19.1340.310.00

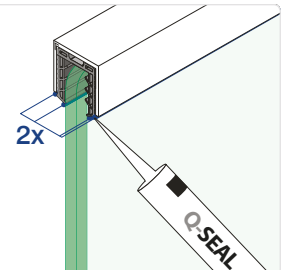

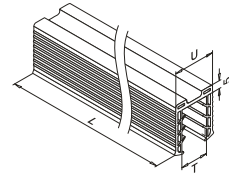
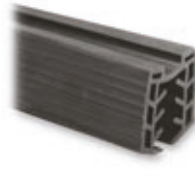
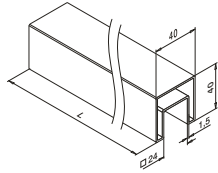

MOD 6925 / 6920

304

INDOOR	□	☐
13.6925.040.12	40 x 40	L = 2500 mm
13.6920.040.12	40 x 40	L = 5000 mm

316

OUTDOOR	□	☐
14.6925.040.12	40 x 40	L = 2500 mm
14.6920.040.12	40 x 40	L = 5000 mm



MOD 50 - □ 40 x 40 mm

Accessories

	U	T	☐
19.5042.208.00	24	8 - 11	L = 2500 mm
19.5042.211.00	24	11,5 - 13,5	L = 2500 mm
19.5042.215.00	24	15	L = 2500 mm
19.5042.216.00	24	16 - 17,5	L = 2500 mm
19.5042.219.00	24	19	L = 2500 mm
19.5042.222.00	24	20 - 21,5	L = 2500 mm

19.5042.008.00	24	8 - 11	L = 5000 mm
19.5042.011.00	24	11,5 - 13,5	L = 5000 mm
19.5042.015.00	24	15	L = 5000 mm
19.5042.016.00	24	16 - 17,5	L = 5000 mm
19.5042.019.00	24	19	L = 5000 mm
19.5042.022.00	24	20 - 21,5	L = 5000 mm

19.5042.508.00	24	8 - 11	L = 25 m
19.5042.511.00	24	11,5 - 13,5	L = 25 m
19.5042.515.00	24	15	L = 25 m
19.5042.516.00	24	16 - 17,5	L = 25 m
19.5042.519.00	24	19	L = 25 m
19.5042.522.00	24	20 - 21,5	L = 25 m

Q-INFO

MOD 6925 / 6920

Calculation basis for cap rails

calculated by **ONDRA**

	□ (mm)	A (cm ²)	I _x (cm ⁴)	I _y (cm ⁴)	W _x (cm ³)	W _y (cm ³)	M (kg/m)	R _{p0,2} (kN/cm ²)	R _m (kN/cm ²)
13.6925.040.12 / 13.6920.040.12	40 x 40	3,00	4,95	6,80	2,31	3,40	2,40	23	54
14.6925.040.12 / 14.6920.040.12	40 x 40	3,00	4,95	6,80	2,31	3,40	2,40	24	53

A = cross sectional area
 I_x / I_y = second moment of area
 W_x / W_y = section modulus
 M = weight
 R_{p0,2} = permissible stress
 R_m = minimum tensile strength

Q-INFO

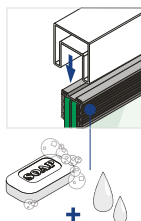
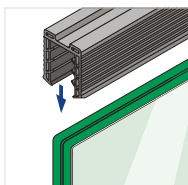

Q-24 Q-seal, 310ml
19.1340.310.00

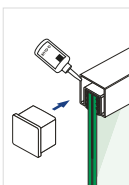
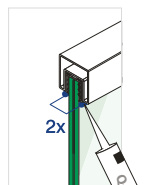

Q-21 Q-glue, 50 ml
19.1331.000.00

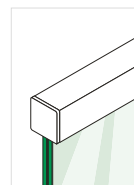

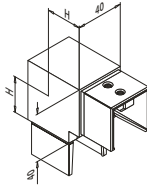

MOD 6303

304			
INDOOR	□	H	
13.6303.040.12	40 x 40	30	2
316			
OUTDOOR	□	H	
14.6303.040.12	40 x 40	30	2

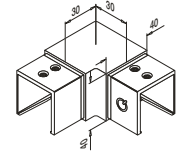

MOD 6313

304			
INDOOR	□		
13.6313.040.12	40 x 40		2
316			
OUTDOOR	□		
14.6313.040.12	40 x 40		2

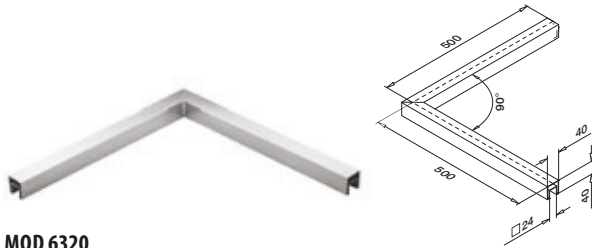

MOD 6320

316			
OUTDOOR	□		
14.6320.040.12	40 x 40		1



MOD 6302

304			
INDOOR	□	H	
13.6302.040.12	40 x 40	30	2
316			
OUTDOOR	□	H	
14.6302.040.12	40 x 40	30	2



MOD 6312

304			
INDOOR	□	H	
13.6312.040.12	40 x 40	30	2
316			
OUTDOOR	□	H	
14.6312.040.12	40 x 40	30	2



Q-INFO MOD 6320

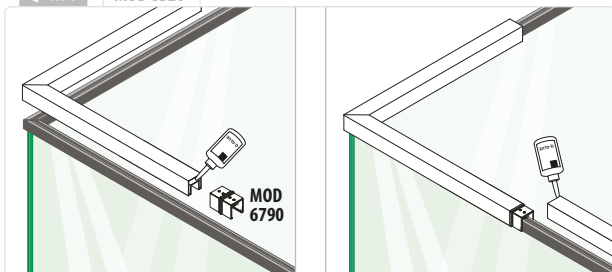

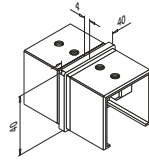

MOD 6790

304

INDOOR	□	
13.6790.040.12	40 x 40	2

316

OUTDOOR	□	
14.6790.040.12	40 x 40	2

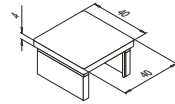

MOD 6732

304

INDOOR	□	
13.6732.040.12	40 x 40	2

316

OUTDOOR	□	
14.6732.040.12	40 x 40	2

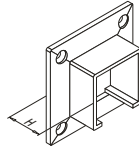
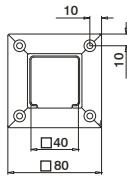

MOD 6505

304

INDOOR	□	H		
13.6505.040.12	40 x 40	29	QS-7	302
				2

316

OUTDOOR	□	H		
14.6505.040.12	40 x 40	29	QS-50	302
				2



Q-INFO



Q-23

Q-cleaner
300 ml
19.0601.000.00

Q-INFO



Q-22

Q-ultra-clean
500 ml
19.0610.000.00

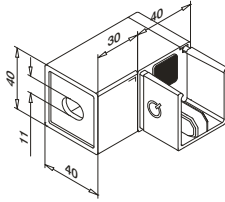

MOD 6507

316

OUTDOOR

14.6507.040.12	40 x 40	QS-64	306	2
----------------	---------	-------	-----	---



International Design Model Protection

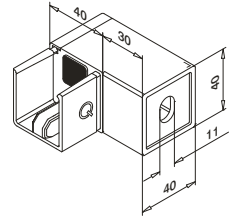

MOD 6508

316

OUTDOOR

14.6508.040.12	40 x 40	QS-64	306	2
----------------	---------	-------	-----	---



International Design Model Protection

Q-INFO

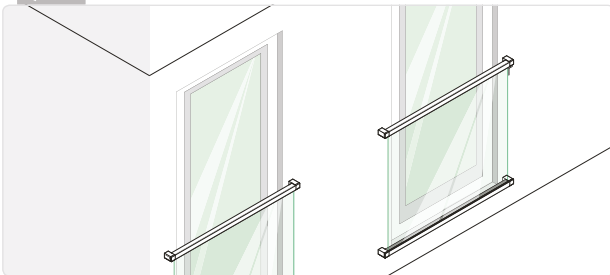

Q-INFO

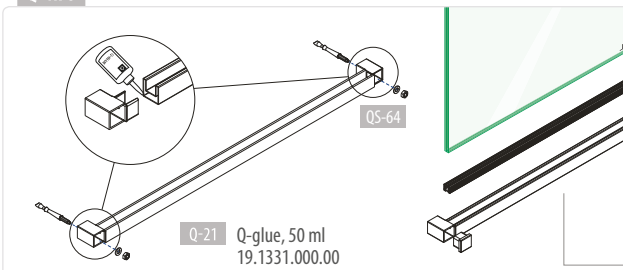

Q-21 Q-glye, 50 ml
19.1331.000.00

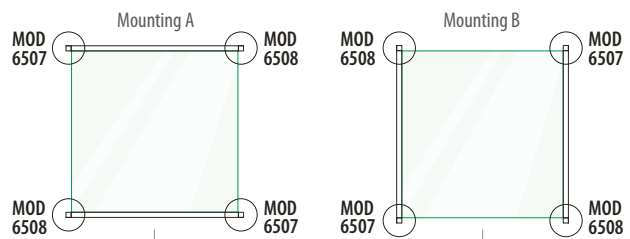

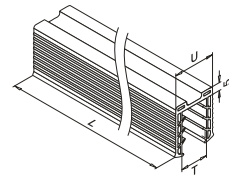
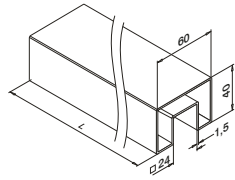

MOD 6925 / 6920

304

INDOOR	□	☐
13.6925.640.12	60 x 40	L = 2500 mm
13.6920.640.12	60 x 40	L = 5000 mm

316

OUTDOOR	□	☐
14.6925.640.12	60 x 40	L = 2500 mm
14.6920.640.12	60 x 40	L = 5000 mm



MOD 50 - □ 60 x 40 mm

Accessories

	U	T	☐
19.5042.208.00	24	8 - 11	L = 2500 mm
19.5042.211.00	24	11,5 - 13,5	L = 2500 mm
19.5042.215.00	24	15	L = 2500 mm
19.5042.216.00	24	16 - 17,5	L = 2500 mm
19.5042.219.00	24	19	L = 2500 mm
19.5042.222.00	24	20 - 21,5	L = 2500 mm

19.5042.008.00	24	8 - 11	L = 5000 mm
19.5042.011.00	24	11,5 - 13,5	L = 5000 mm
19.5042.015.00	24	15	L = 5000 mm
19.5042.016.00	24	16 - 17,5	L = 5000 mm
19.5042.019.00	24	19	L = 5000 mm
19.5042.022.00	24	20 - 21,5	L = 5000 mm

19.5042.508.00	24	8 - 11	L = 25 m
19.5042.511.00	24	11,5 - 13,5	L = 25 m
19.5042.515.00	24	15	L = 25 m
19.5042.516.00	24	16 - 17,5	L = 25 m
19.5042.519.00	24	19	L = 25 m
19.5042.522.00	24	20 - 21,5	L = 25 m

Q-INFO

MOD 6925 / 6920

Calculation basis for cap rails

calculated by **ONDRA**

	□ (mm)	A (cm ²)	I _x (cm ⁴)	I _y (cm ⁴)	W _x (cm ³)	W _y (cm ³)	M (kg/m)	R _{p0,2} (kN/cm ²)	R _m (kN/cm ²)
13.6925.640.12 / 13.6920.640.12	60 x 40	3,60	7,18	15,90	3,40	5,30	2,90	23	54
14.6925.640.12 / 14.6920.640.12	60 x 40	3,60	7,18	15,90	3,40	5,30	2,90	24	53

A = cross sectional area W_x / W_y = section modulus R_{p0,2} = permissible stress
 I_x / I_y = second moment of area M = weight R_m = minimum tensile strength

Q-INFO

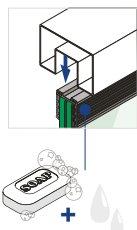
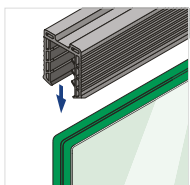

Q-24 Q-seal, 310ml
19.1340.310.00

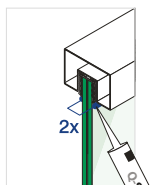

Q-21 Q-glue, 50 ml
19.1331.000.00

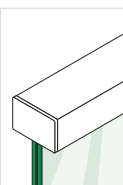
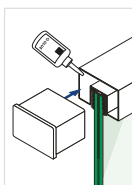

Q-INFO



Q-23
Q-cleaner
300 ml
19.0601.000.00

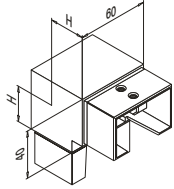

MOD 6303

304			
INDOOR	□	H	
13.6303.640.12	60 x 40	30	2
316			
OUTDOOR	□	H	
14.6303.640.12	60 x 40	30	2

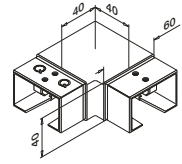

MOD 6313

304			
INDOOR	□		
13.6313.640.12	60 x 40		2
316			
OUTDOOR	□		
14.6313.640.12	60 x 40		2



25–55°
Downwards

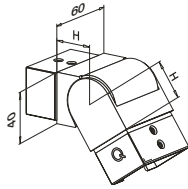

MOD 6302

304			
INDOOR	□	H	
13.6302.640.12	60 x 40	30	2
316			
OUTDOOR	□	H	
14.6302.640.12	60 x 40	30	2



25–55°
Upwards

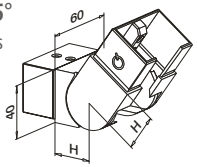

MOD 6312

304			
INDOOR	□	H	
13.6312.640.12	60 x 40	30	2
316			
OUTDOOR	□	H	
14.6312.640.12	60 x 40	30	2

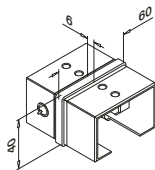

MOD 6790

304			
INDOOR	□		
13.6790.640.12	60 x 40		2
316			
OUTDOOR	□		
14.6790.640.12	60 x 40		2

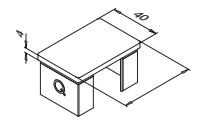

MOD 6732

304			
INDOOR	□		
13.6732.640.12	60 x 40		2
316			
OUTDOOR	□		
14.6732.640.12	60 x 40		2

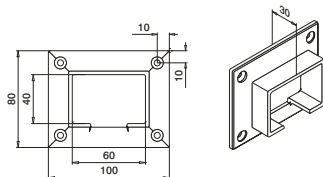

MOD 6505

304			
INDOOR	□		
13.6505.640.12	60 x 40	QS-7 302	2
316			
OUTDOOR	□		
14.6505.640.12	60 x 40	QS-50 302	2



EASY GLASS® -
Cap rails, rectangular

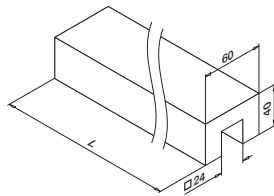

MOD 6920 - Beech, lacquered

Wood

INDOOR	□	▢
20.6920.640.40	60 x 40	L = 2500 mm

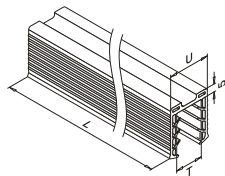
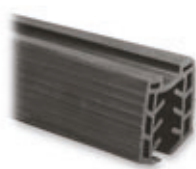

MOD 50 - □ 60 x 40 mm

Accessories			
	U	T	▢
19.5042.208.00	24	8 - 11	L = 2500 mm
19.5042.211.00	24	11,5 - 13,5	L = 2500 mm
19.5042.215.00	24	15	L = 2500 mm
19.5042.216.00	24	16 - 17,5	L = 2500 mm
19.5042.219.00	24	19	L = 2500 mm
19.5042.222.00	24	20 - 21,5	L = 2500 mm
19.5042.008.00	24	8 - 11	L = 5000 mm
19.5042.011.00	24	11,5 - 13,5	L = 5000 mm
19.5042.015.00	24	15	L = 5000 mm
19.5042.016.00	24	16 - 17,5	L = 5000 mm
19.5042.019.00	24	19	L = 5000 mm
19.5042.022.00	24	20 - 21,5	L = 5000 mm
19.5042.508.00	24	8 - 11	L = 25 m
19.5042.511.00	24	11,5 - 13,5	L = 25 m
19.5042.515.00	24	15	L = 25 m
19.5042.516.00	24	16 - 17,5	L = 25 m
19.5042.519.00	24	19	L = 25 m
19.5042.522.00	24	20 - 21,5	L = 25 m

Q-INFO MOD 6920

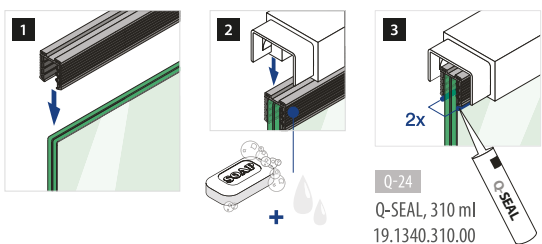

Q-INFO MOD 6313 / 6790 / 6729

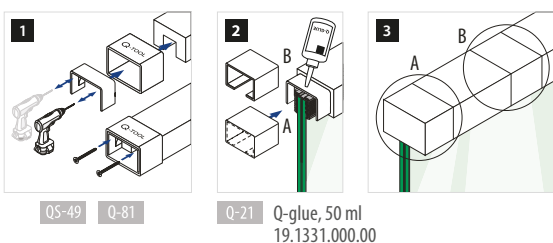

EASY GLASS® -
Connectors and end fittings, rectangular

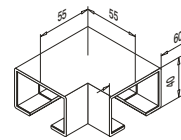
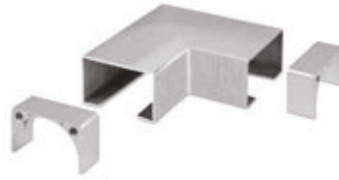

MOD 6313

304	□	▢
INDOOR	60 x 40	QS-49 □ 302
20.6313.640.12		2

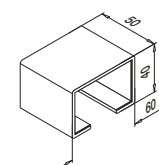
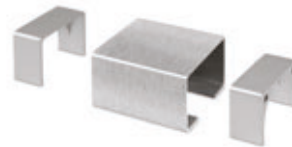

MOD 6790

304	□	▢
INDOOR	60 x 40	QS-49 □ 302
20.6790.640.12		2

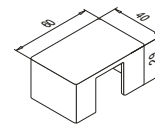
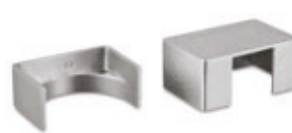

MOD 6729

304	□	▢
INDOOR	60 x 40	QS-49 □ 302
20.6729.640.12		2

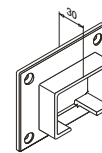
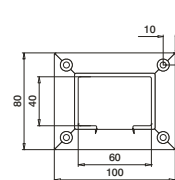

MOD 6505

304	□	▢
INDOOR	60 x 40	QS-7 □ 302
13.6505.640.12		2



Mounting tool

MOD 0710

Accessories		
	Q	▢
19.0710.640.35	Q-81	1

Wood is a natural product. Colours can differ.

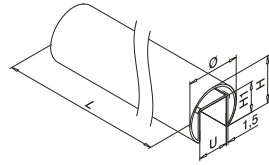
**MOD 6925 / 6920**

Ø 42,4 mm

304

INDOOR	Ø	U	H	H1	
13.6925.042.12	42,4	24	37	24	L = 2500 mm
13.6920.042.12	42,4	24	37	24	L = 5000 mm

316

OUTDOOR	Ø	U	H	H1	
14.6925.042.12	42,4	24	37	24	L = 2500 mm
14.6920.042.12	42,4	24	37	24	L = 5000 mm

Ø 48,3 mm

304

INDOOR	Ø	U	H	H1	
13.6925.048.12	48,3	27	42,6	30	L = 2500 mm
13.6920.048.12	48,3	27	42,6	30	L = 5000 mm

316

OUTDOOR	Ø	U	H	H1	
14.6925.048.12	48,3	27	42,6	30	L = 2500 mm
14.6920.048.12	48,3	27	42,6	30	L = 5000 mm

Ø 60,3 mm

304

INDOOR	Ø	U	H	H1	
13.6925.060.12	60,3	34	53	34	L = 2500 mm
13.6920.060.12	60,3	34	53	34	L = 5000 mm

316

OUTDOOR	Ø	U	H	H1	
14.6925.060.12	60,3	34	53	34	L = 2500 mm
14.6920.060.12	60,3	34	53	34	L = 5000 mm

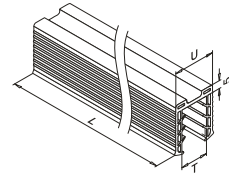
**MOD 50**

Ø 42,4 mm

Accessories

	U	T	
19.5042.208.00	24	8 - 11	L = 2500 mm
19.5042.211.00	24	11,5 - 13,5	L = 2500 mm
19.5042.215.00	24	15	L = 2500 mm
19.5042.216.00	24	16 - 17,5	L = 2500 mm
19.5042.219.00	24	19	L = 2500 mm
19.5042.222.00	24	20 - 21,5	L = 2500 mm

19.5042.008.00	24	8 - 11	L = 5000 mm
19.5042.011.00	24	11,5 - 13,5	L = 5000 mm
19.5042.015.00	24	15	L = 5000 mm
19.5042.016.00	24	16 - 17,5	L = 5000 mm
19.5042.019.00	24	19	L = 5000 mm
19.5042.022.00	24	20 - 21,5	L = 5000 mm

19.5042.508.00	24	8 - 11	L = 25 mm
19.5042.511.00	24	11,5 - 13,5	L = 25 mm
19.5042.515.00	24	15	L = 25 mm
19.5042.516.00	24	16 - 17,5	L = 25 mm
19.5042.519.00	24	19	L = 25 mm
19.5042.522.00	24	20 - 21,5	L = 25 mm

Ø 48,3 mm

Accessories

	U	T	
19.5048.008.00	27	8 - 11	L = 5000 mm
19.5048.011.00	27	11,5 - 13,5	L = 5000 mm
19.5048.015.00	27	15 - 17,5	L = 5000 mm
19.5048.019.00	27	19	L = 5000 mm
19.5048.022.00	27	20,5 - 21,5	L = 5000 mm

Ø 60,3 mm

Accessories

	U	T	
19.5060.008.00	34	8 - 11	L = 5000 mm
19.5060.011.00	34	11,5 - 13,5	L = 5000 mm
19.5060.016.00	34	16 - 17,5	L = 5000 mm
19.5060.019.00	34	19	L = 5000 mm
19.5060.022.00	34	20,5 - 21,5	L = 5000 mm
19.5060.024.00	34	24,76 - 25,52	L = 5000 mm
19.5060.031.00	34	31,52	L = 5000 mm

Q-INFO**MOD 6925 / 6920**

Calculation basis for cap rails

calculated by ONDR

	Ø (mm)	A (cm ²)	I _x (cm ⁴)	I _y (cm ⁴)	W _x (cm ³)	W _y (cm ³)	M (kg / m)	R _{p0,2} (kN / cm ²)	R _m (kN / cm ²)
13.6925.042.12 13.6920.042.12	42,4	2,58	2,80	5,11	1,66	2,41	2,02	23	54
14.6925.042.12 14.6920.042.12	42,4	2,58	2,80	5,11	1,66	2,41	2,02	24	53
13.6925.048.12 13.6920.048.12	48,3	3,02	4,48	7,71	2,33	3,19	2,37	23	54
14.6925.048.12 14.6920.048.12	48,3	3,02	4,48	7,71	2,33	3,19	2,37	24	53
13.6925.060.12 13.6920.060.12	60,3	3,69	8,65	14,94	3,15	4,96	2,90	23	54

A = cross sectional area
I_x / I_y = second moment of areaW_x / W_y = section modulus
M = weightR_{p0,2} = permissible stress
R_m = minimum tensile strength

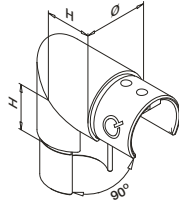

MOD 6303

304				
INDOOR	Ø	H		
13.6303.042.12	42,4 x 1,5	30	2	
13.6303.048.12	48,3 x 1,5	35	2	
13.6303.060.12	60,3 x 1,5	40	2	
316				
OUTDOOR	Ø	H		
14.6303.042.12	42,4 x 1,5	30	2	
14.6303.048.12	48,3 x 1,5	35	2	

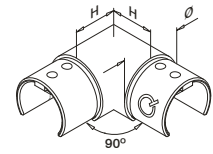

MOD 6313

304				
INDOOR	Ø	H		
13.6313.042.12	42,4 x 1,5	30	2	
13.6313.048.12	48,3 x 1,5	35	2	
13.6313.060.12	60,3 x 1,5	40	2	
316				
OUTDOOR	Ø	H		
14.6313.042.12	42,4 x 1,5	30	2	
14.6313.048.12	48,3 x 1,5	35	2	

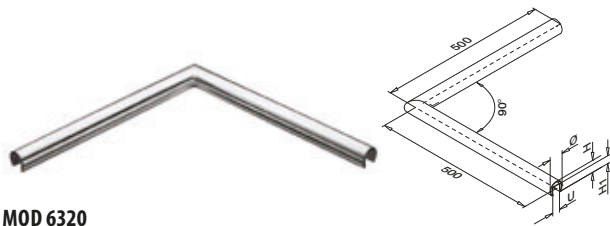

MOD 6320

304						
INDOOR	Ø	U	H	H1		
13.6320.042.12	42,4 x 1,5	24	37	24	1	
316						
OUTDOOR	Ø	U	H	H1		
14.6320.042.12	42,4 x 1,5	24	37	24	1	
14.6320.048.12	48,3 x 1,5	27	42,6	30	1	

NEW



25–55°
Downwards

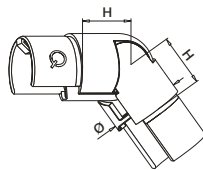

MOD 6302

304				
INDOOR	Ø	H		
13.6302.042.12	42,4 x 1,5	30	2	
13.6302.048.12	48,3 x 1,5	35	2	
13.6302.060.12	60,3 x 1,5	40	2	
316				
OUTDOOR	Ø	H		
14.6302.042.12	42,4 x 1,5	30	2	
14.6302.048.12	48,3 x 1,5	35	2	



25–55°
Upwards

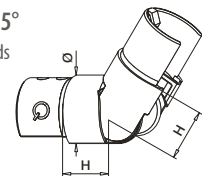

MOD 6312

304				
INDOOR	Ø	H		
13.6312.042.12	42,4 x 1,5	30	2	
13.6312.048.12	48,3 x 1,5	35	2	
13.6312.060.12	60,3 x 1,5	40	2	
316				
OUTDOOR	Ø	H		
14.6312.042.12	42,4 x 1,5	30	2	
14.6312.048.12	48,3 x 1,5	35	2	



Q-INFO



Q-21
Q-glue
50 ml
19.1331.000.00



Consumption per bonding ca. 1 ml

Q-Video www.q-railing.com

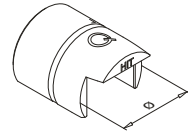
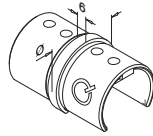

MOD 6790

304

INDOOR	Ø	
13.6790.042.12	42,4 x 1,5	2
13.6790.048.12	48,3 x 1,5	2
13.6790.060.12	60,3 x 1,5	2

316

OUTDOOR	Ø	
14.6790.042.12	42,4 x 1,5	2
14.6790.048.12	48,3 x 1,5	2



MOD 6792 - EASY HIT®

304

Raw

INDOOR	Ø	
13.6792.042.00	for 42,4 x 1,5	2
13.6792.048.00	for 48,3 x 1,5	2
13.6792.060.00	for 60,3 x 1,5	2

316

OUTDOOR	Ø	
14.6792.042.00	for 42,4 x 1,5	2
14.6792.048.00	for 48,3 x 1,5	2
14.6792.060.00	for 60,3 x 1,5	2



International Design Model Protection

Q-INFO

MOD 6792

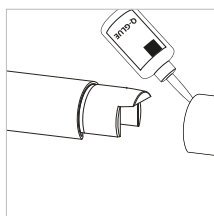
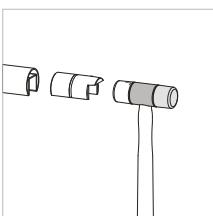

Q-21
Q-glue
50 ml
19.1331.000.00

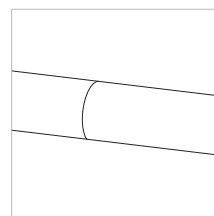

Q-INFO

EASY HIT®



EASY GLASS® - End fittings, round



MOD 6738

304

INDOOR	Ø	L	
13.6738.042.12	42,4 x 1,5	60	2
13.6738.048.12	48,3 x 1,5	65	2

316

OUTDOOR	Ø	L	
14.6738.042.12	42,4 x 1,5	60	2
14.6738.048.12	48,3 x 1,5	65	2



International Design Model Protection

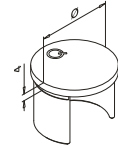

MOD 6732

304

INDOOR	Ø	
13.6732.042.12	42,4 x 1,5	2
13.6732.048.12	48,3 x 1,5	2
13.6732.060.12	60,3 x 1,5	2

316

OUTDOOR	Ø	
14.6732.042.12	42,4 x 1,5	2
14.6732.048.12	48,3 x 1,5	2



EASY GLASS® - Cap rail adapter

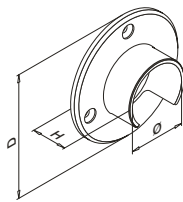

MOD 6505

304

INDOOR	Ø	D	H		
13.6505.042.12	42,4	90	30	QS-5	302 2
13.6505.048.12	48,3	95	35	QS-5	302 2
13.6505.060.12	60,3	107	35	QS-5	302 2

316

OUTDOOR	Ø	D	H		
14.6505.042.12	42,4	90	30	QS-6	302 2
14.6505.048.12	48,3	95	35	QS-6	302 2

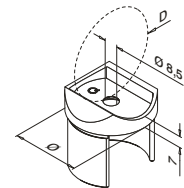

MOD 6727

304

INDOOR	D	Ø		
13.6727.042.12	42,4	42,4 x 1,5	QS-26	303 2

316

OUTDOOR	D	Ø		
14.6727.042.12	42,4	42,4 x 1,5	QS-27	303 2



Q-INFO MOD 6738

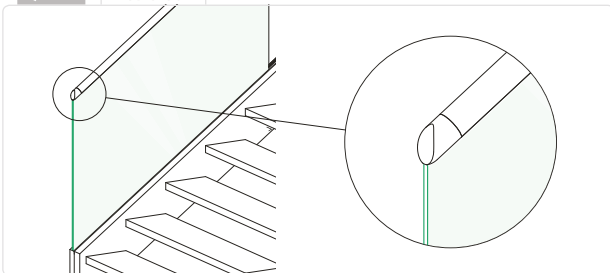

Q-INFO MOD 6727

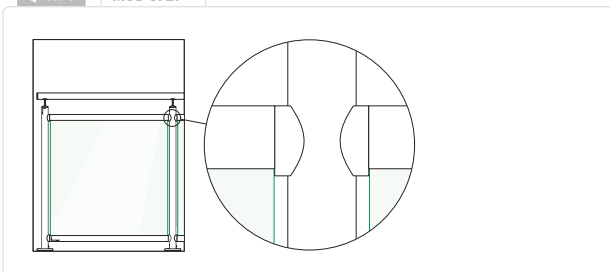

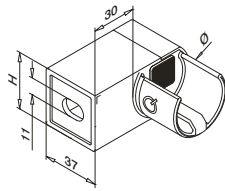

MOD 6507

316

OUTDOOR	Ø	H		
14.6507.042.12	42,4	37	QS-64	306 2
14.6507.048.12	48,3	43	QS-64	306 2



International Design Model Protection

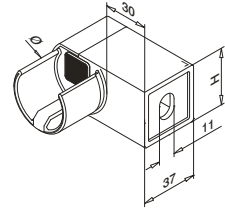

MOD 6508

316

OUTDOOR	Ø	H		
14.6508.042.12	42,4	37	QS-64	306 2
14.6508.048.12	48,3	43	QS-64	306 2



International Design Model Protection

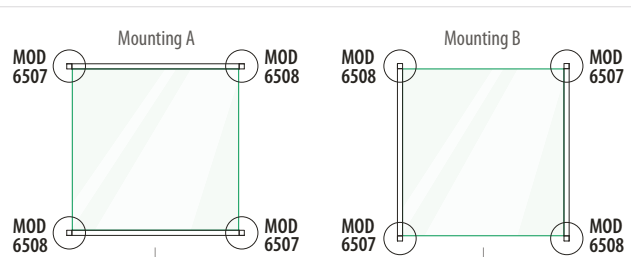
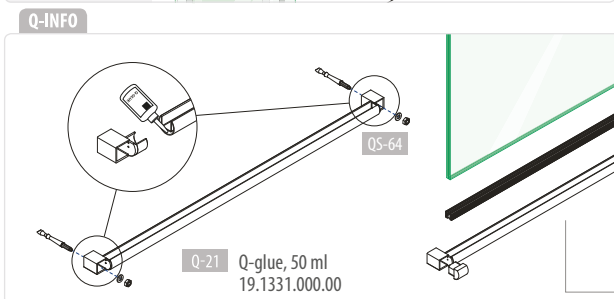
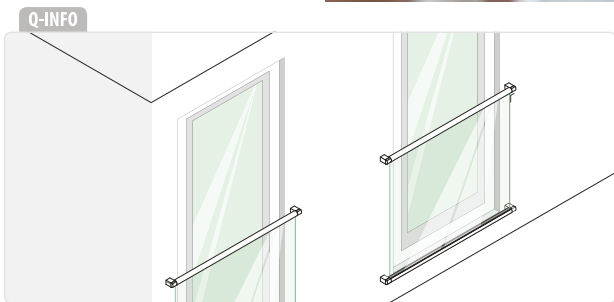
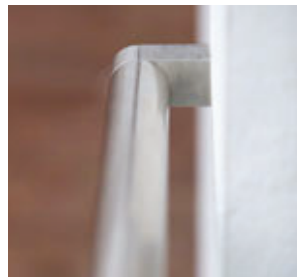

Top/handrails, wood

WOOD

EASY GLASS® -
Cap rails, round

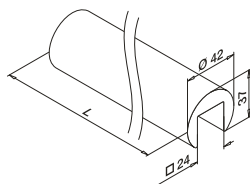

MOD 6925 - Beech, lacquered

Wood			
INDOOR	Ø	L = 2500 mm	
20.6925.042.40	42,0		

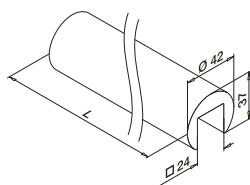

MOD 6925 - Oak, lacquered

Wood			
INDOOR	Ø	L = 2500 mm	
20.6925.042.43	42,0		

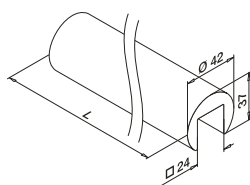

MOD 6925 - Beech, P11 stained and lacquered

Wood			
INDOOR	Ø	L = 2500 mm	
20.6925.042.41	42,0		

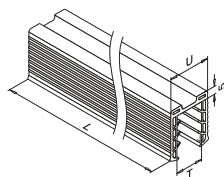
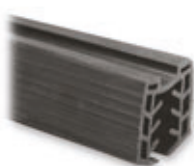

MOD 50 - Ø 42,0 mm

Accessories			
	U	T	L
19.5042.208.00	24	8 - 11	L = 2500 mm
19.5042.211.00	24	11,5 - 13,5	L = 2500 mm
19.5042.215.00	24	15	L = 2500 mm
19.5042.216.00	24	16 - 17,5	L = 2500 mm
19.5042.219.00	24	19	L = 2500 mm
19.5042.222.00	24	20 - 21,5	L = 2500 mm
19.5042.008.00	24	8 - 11	L = 5000 mm
19.5042.011.00	24	11,5 - 13,5	L = 5000 mm
19.5042.015.00	24	15	L = 5000 mm
19.5042.016.00	24	16 - 17,5	L = 5000 mm
19.5042.019.00	24	19	L = 5000 mm
19.5042.022.00	24	20 - 21,5	L = 5000 mm
19.5042.508.00	24	8 - 11	L = 25 m
19.5042.511.00	24	11,5 - 13,5	L = 25 m
19.5042.515.00	24	15	L = 25 m
19.5042.516.00	24	16 - 17,5	L = 25 m
19.5042.519.00	24	19	L = 25 m
19.5042.522.00	24	20 - 21,5	L = 25 m

Top/handrails, wood

SATIN

EASY GLASS® -
Connectors and end fittings, round



MOD 6729

304			
INDOOR	Ø	Q	L
20.6729.042.12	42,0	QS-49	302



MOD 6790

304			
INDOOR	Ø	Q	L
20.6790.042.12	42,0	QS-49	302



Mounting tool

MOD 0710

Accessories			
	Q	L	
19.0710.042.12	Q-20	1	

Wood is a natural product. Colours can differ.

Q-INFO MOD 6925

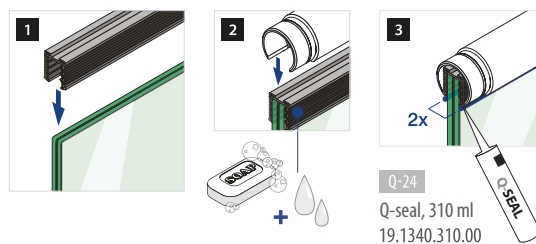

Q-24
Q-seal, 310 ml
19.1340.310.00

Q-INFO MOD 6790 / 6729

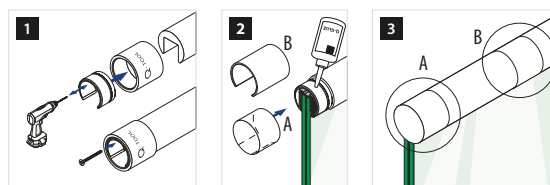

Q-49 Q-20
Q-21 Q-glu, 50 ml
19.1331.000.00

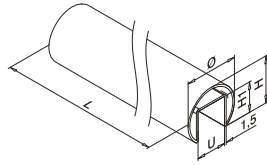

**MOD 6925 / 6920**

Ø 42,4 mm

304

INDOOR	Ø	U	H	H1	
13.6920.042.10	42,4	24	37	24	L = 5000 mm

316

OUTDOOR	Ø	U	H	H1	
14.6920.042.10	42,4	24	37	24	L = 5000 mm

Ø 48,3 mm

304

INDOOR	Ø	U	H	H1	
13.6925.048.10	48,3	27	42,6	30	L = 2500 mm
13.6920.048.10	48,3	27	42,6	30	L = 5000 mm

316

OUTDOOR	Ø	U	H	H1	
14.6925.048.10	48,3	27	42,6	30	L = 2500 mm
14.6920.048.10	48,3	27	42,6	30	L = 5000 mm

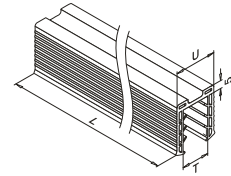
**MOD 50**

Ø 42,4 mm

Accessories

	U	T	
19.5042.208.00	24	8 - 11	L = 2500 mm
19.5042.211.00	24	11,5 - 13,5	L = 2500 mm
19.5042.215.00	24	15	L = 2500 mm
19.5042.216.00	24	16 - 17,5	L = 2500 mm
19.5042.219.00	24	19	L = 2500 mm
19.5042.222.00	24	20 - 21,5	L = 2500 mm

19.5042.008.00	24	8 - 11	L = 5000 mm
19.5042.011.00	24	11,5 - 13,5	L = 5000 mm
19.5042.015.00	24	15	L = 5000 mm
19.5042.016.00	24	16 - 17,5	L = 5000 mm
19.5042.019.00	24	19	L = 5000 mm
19.5042.022.00	24	20 - 21,5	L = 5000 mm

19.5042.508.00	24	8 - 11	L = 25 m
19.5042.511.00	24	11,5 - 13,5	L = 25 m
19.5042.515.00	24	15	L = 25 m
19.5042.516.00	24	16 - 17,5	L = 25 m
19.5042.519.00	24	19	L = 25 m
19.5042.522.00	24	20 - 21,5	L = 25 m

Ø 48,3 mm

Accessories

	U	T	
19.5048.008.00	27	8 - 11	L = 5000 mm
19.5048.011.00	27	11,5 - 13,5	L = 5000 mm
19.5048.015.00	27	15 - 17,5	L = 5000 mm
19.5048.019.00	27	19	L = 5000 mm
19.5048.022.00	27	20,5 - 21,5	L = 5000 mm

Q-INFO

MOD 6925 / 6920

Calculation basis for cap rails

calculated by

	Ø (mm)	A (cm ²)	I _x (cm ⁴)	I _y (cm ⁴)	W _x (cm ³)	W _y (cm ³)	M (kg/m)	R _{p0,2} (kN/cm ²)	R _m (kN/cm ²)
13.6925.048.10 / 13.6920.048.10	48,3	3,02	4,48	7,71	2,33	3,19	2,37	23	54
14.6925.048.10 / 14.6920.048.10	48,3	3,02	4,48	7,71	2,33	3,19	2,37	24	53

A = cross sectional area
I_x / I_y = second moment of area

W_x / W_y = section modulus
M = weight

R_{p0,2} = permissible stress
R_m = minimum tensile strength

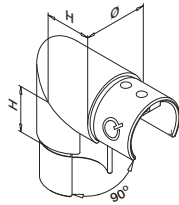

MOD 6303

304

INDOOR	Ø	H	
13.6303.042.10	42,4 x 1,5	30	2
13.6303.048.10	48,3 x 1,5	35	2

316

OUTDOOR	Ø	H	
14.6303.042.10	42,4 x 1,5	30	2
14.6303.048.10	48,3 x 1,5	35	2

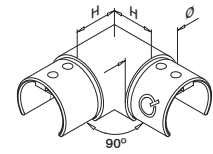

MOD 6313

304

INDOOR	Ø	H	
13.6313.042.10	42,4 x 1,5	30	2
13.6313.048.10	48,3 x 1,5	35	2

316

OUTDOOR	Ø	H	
14.6313.042.10	42,4 x 1,5	30	2
14.6313.048.10	48,3 x 1,5	35	2



25–55°
Downwards

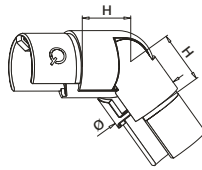

MOD 6302

304

INDOOR	Ø	H	
13.6302.042.10	42,4 x 1,5	30	2
13.6302.048.10	48,3 x 1,5	35	2

316

OUTDOOR	Ø	H	
14.6302.042.10	42,4 x 1,5	30	2
14.6302.048.10	48,3 x 1,5	35	2



25–55°
Upwards

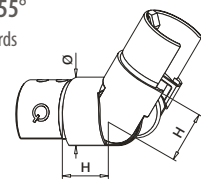

MOD 6312

304

INDOOR	Ø	H	
13.6312.042.10	42,4 x 1,5	30	2
13.6312.048.10	48,3 x 1,5	35	2

316

OUTDOOR	Ø	H	
14.6312.042.10	42,4 x 1,5	30	2
14.6312.048.10	48,3 x 1,5	35	2



Q-INFO



Q-21
Q-glue
50 ml
19.1331.000.00



Consumption per bonding ca. 1 ml

Q-Video www.q-railing.com

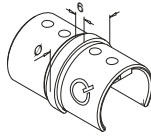

MOD 6790

304			
INDOOR	Ø		
13.6790.042.10	42,4 x 1,5		2
13.6790.048.10	48,3 x 1,5		2
316			
OUTDOOR	Ø		
14.6790.042.10	42,4 x 1,5		2
14.6790.048.10	48,3 x 1,5		2

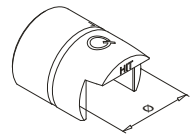

MOD 6792 - EASY HIT®

304				Raw
INDOOR	Ø			
13.6792.042.00	for 42,4 x 1,5		2	
13.6792.048.00	for 48,3 x 1,5		2	
316				
OUTDOOR	Ø			
14.6792.042.00	for 42,4 x 1,5		2	
14.6792.048.00	for 48,3 x 1,5		2	



International Design Model Protection

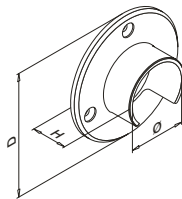

MOD 6505

304						
INDOOR	Ø	D	H			
13.6505.042.10	42,4	90	30	Q5-5	302	2
13.6505.048.10	48,3	95	35	Q5-5	302	2
316						
OUTDOOR	Ø	D	H			
14.6505.042.10	42,4	90	30	Q5-6	302	2
14.6505.048.10	48,3	95	35	Q5-6	302	2

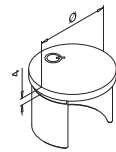

MOD 6732

304			
INDOOR	Ø		
13.6732.042.10	42,4 x 1,5		2
13.6732.048.10	48,3 x 1,5		2
316			
OUTDOOR	Ø		
14.6732.042.10	42,4 x 1,5		2
14.6732.048.10	48,3 x 1,5		2



For more information, please visit our website: www.q-railing.com

Q-INFO MOD 6792

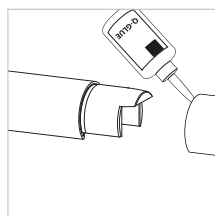
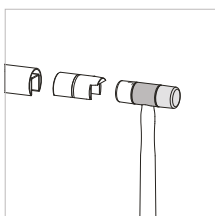

Q-21
Q-glue
50 ml
19.1331.000.00

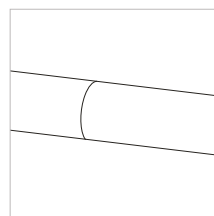

Q-INFO



Q-22
Q-ultra-clean
500 ml
19.0610.000.00



BALUSTER
RAILING SYSTEMS

2

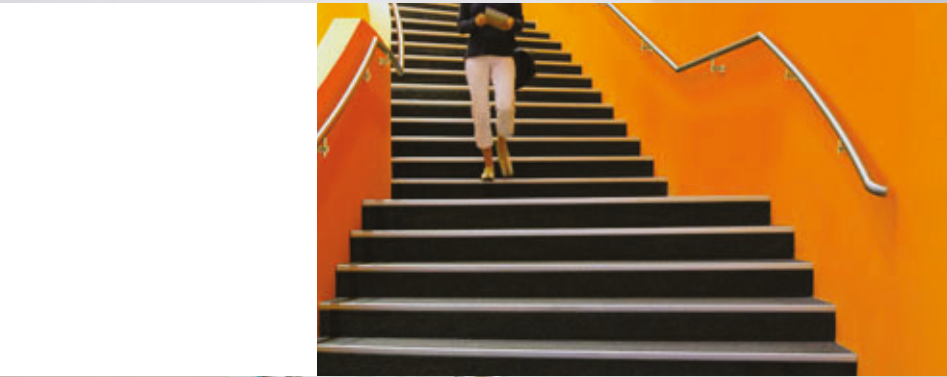

CREATE YOUR OWN VISION

You're in full control of your railing system's design thanks to a huge choice of style options within our range. Round, square or flat, with wooden handrails, glass infills or even stainless steel cable systems. The possibilities are endless!

Modular and fully compatible systems

Q-railing components can be connected in countless different combinations, so you can create your own unique design to suit your needs. Even tight corners, uneven floors or hard-to-reach places pose no problem - our products provide a practical solution to every challenge.

Smart installation

You can install our systems quickly and easily - it's one of the hallmarks of Q-railing's quality products. There's no need for expensive and time-consuming welding, as installation is achieved with just gluing, screwing and clamping. Our solutions are comprehensive; whatever you need during installation, Q-railing can provide. And you can keep your railing systems in good condition for years to come with our complete range of maintenance and cleaning products, specifically tailored for every use.



INDEX

QUICKRAIL®

Baluster posts



82
Baluster posts



82
Baluster brackets

Infills



84 - 86
Glass infills



87 - 88
Tube and bar infills



89
Cable infills

Handrails



90
Handrail brackets

LINEAR LINE

Baluster posts

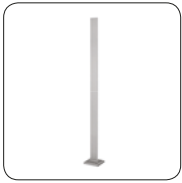

92
Baluster posts



92
Cover caps

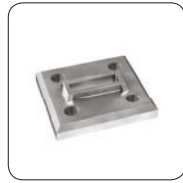

93
Flanges
for baluster posts



93
Baluster brackets



95
Adapters

Infills



95 - 96
Glass infills



97 - 98
Tube and bar infills



99
Handrail brackets



99
Handrail adapters

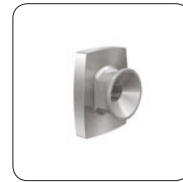

100
Adapters



100
Adapters for tube

Handrails

SQUARE LINE® 40x40

Baluster posts

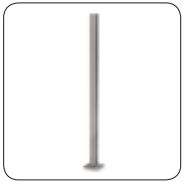

102
Baluster posts
and accessories



104
Base flanges
for glue connection

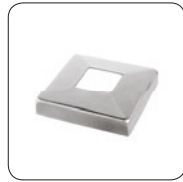

104
Cover caps



104
Stair flanges
for glue connection



106 - 108
Baluster brackets



109
Bar infills

Handrails



110 - 113
Handrail brackets



114
Handrail adapters



114
Handrail parts



115
Tubes



115 - 116
Connectors



117
End fittings

SQUARE LINE® 40x10

Handrails



119
Handrail brackets



119
Tubes



120
Connectors



120
End fittings

SQUARE LINE® 60x30

Baluster posts

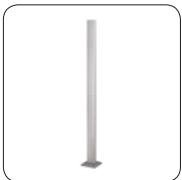

122
Baluster posts



122
Flanges
for baluster posts

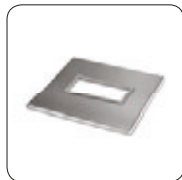

123
Cover caps



122
End fittings



122
Tubes



123
Baluster brackets

Handrails



125
Handrail brackets



125
Handrail adapters



125
Tubes



126
Connectors



126
End fittings

Q-LINE SATIN

Baluster posts



129
Baluster posts
Extra Strong



130 - 131
Baluster posts
and accessories

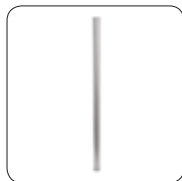

132 - 134
Baluster post tubes
(with threaded holes)



134 - 135
Base flanges
for glue connection



136
Stair flanges
for glue connection

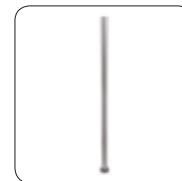

137
Baluster posts and
accessories for stairs



142 - 143
Cover caps



139 - 141
Baluster brackets

INDEX

Q-LINE SATIN

Infills



145 - 148
Glass infills



150 - 159
Tube and bar infills

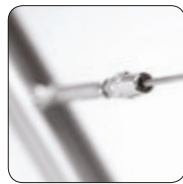

161 - 167
Cable infills

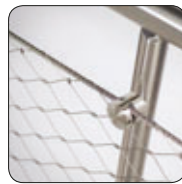

169 - 171
Web infills

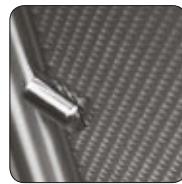

172 - 174
Plate infills

Handrails



175 - 190
Handrail brackets



190 - 191
Handrail adapters



192 - 195
Handrail parts



196 - 198
Tubes



199
Tube brackets



200 - 207
Connectors



208 - 210
End fittings

Q-LINE POLISHED

Baluster posts



212
Baluster posts and accessories



213
Baluster brackets



212
Cover caps

Infills



214 - 216
Glass infills



217
Tube and bar infills

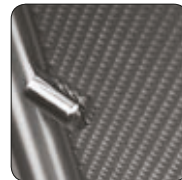

218
Plate infills

Handrails



219 - 221
Handrail brackets



219
Cover caps



222
Handrail adapters



223
Tubes



223 - 224
Connectors



224
End fittings

WELDING PARTS

Baluster posts



226 - 227
Flanges
for baluster posts



226 - 227
Baluster brackets



228
End caps for baluster
posts and tubes

Handrails



229
Handrail brackets



228
Flanges for handrails



230 - 232
Handrail parts

Q-LIGHTS

Handrails



234 - 236
LED-spotlights



237
Connection
technology



238
Handrail brackets



239
Handrail adapters



239
Connectors



239
End fittings

BENDYWOOD

Handrails



241
Handrails

NATURAIL

Handrails



243
Handrails



244 - 246
Connectors
and end fittings

ULTRA RANGE

Baluster posts



248
Base flanges for glue
connection and
accessories

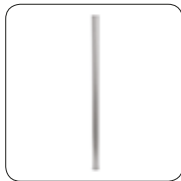

248
Baluster post tubes

Infills



249
Glass infills

Handrails



250 - 251
Handrail brackets and
handrail adapters



251
Tubes



252
Connectors
and end fittings

TESTED

Q-line

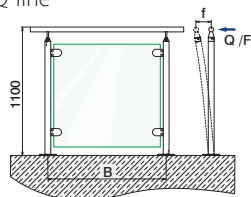

	Q	B (max)	f
MOD 0561	0,50 kN/m	1500 mm	≤ 25 mm
	0,74 kN/m	1500 mm	≤ 25 mm
	1,00 kN/m	1100 mm	≤ 25 mm
	1,50 kN/m	1100 mm	≤ 25 mm

British Standard BS 6399

BS 6399-1: 1996 (incorp. amendm. No. 1)

	Q	B (max)	f
MOD 0551.048	0,50 kN/m	1200 mm	≤ 25 mm
	0,74 kN/m	1200 mm	≤ 35 mm
MOD 0711.248	1,00 kN/m	1100 mm	≤ 25 mm
MOD 0716.248	1,00 kN/m	1100 mm	≤ 25 mm
	1,50 kN/m	1100 mm	≤ 35 mm
MOD 0914.248	0,50 kN/m	1300 mm	≤ 25 mm
	0,74 kN/m	1300 mm	≤ 35 mm

Linear Line (Static calculation)

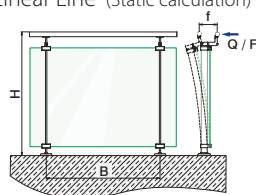

	Q	F	Indoor		Outdoor		H (max)	f
			B (max)	B (max)	wind			
MOD 0547.054	0,50 kN/m	-	1400 mm	1150 mm	0,70* kN/m ²	1100 mm	< 25 mm	
	0,50 kN/m	1,00 kN/1 min.	1100 mm	1100 mm	1,95 kN/m ²	1000 mm	< 20 mm	
	1,00 kN/m	-	850 mm	800 mm	0,70* kN/m ²	1100 mm	< 25 mm	
	0,80 kN/m	1,00 kN/5 min.	1100 mm	1100 mm	1,95 kN/m ²	1000 mm	< 20 mm	

Square Line® 60x30 (Static calculation)

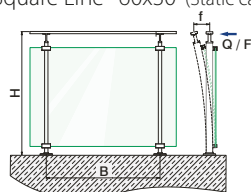

	Q	F	Indoor		Outdoor		H (max)	f
			B (max)	B (max)	wind			
MOD 4901.063	0,50 kN/m	-	1500 mm	1300 mm	0,70* kN/m ²	1100 mm	< 25 mm	
	0,50 kN/m	1,00 kN/1 min.	1200 mm	1200 mm	1,79 kN/m ²	1000 mm	< 20 mm	
	1,00 kN/m	-	1000 mm	900 mm	0,70* kN/m ²	1100 mm	< 25 mm	
	0,80 kN/m	1,00 kN/5 min.	1200 mm	1200 mm	1,79 kN/m ²	1000 mm	< 20 mm	

* Line load and wind force combined





QUICKRAIL®

When your project calls for a symmetrical, industrial look with lots of sharp corners and visible parts, Quickrail® delivers. Installation is simple and quick, with no drilling required. The infill holders are simply pushed into the baluster posts' hidden track and locked in place. Quickrail easily accommodates glass, cable or bar infill.



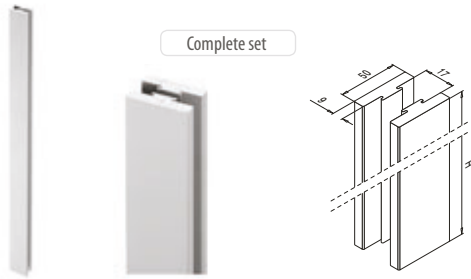

MOD 0545 / 0546

Material	Stainless steel effect	H	
Aluminium			
OUTDOOR			
16.0545.050.18		1000 mm	1 set
16.0546.050.18		1200 mm	1 set

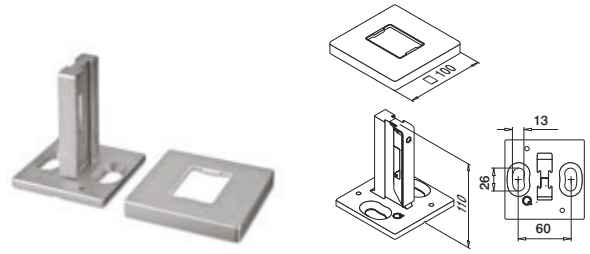

MOD 9011

Material	304	316	
INDOOR			
13.9011.050.12	QS-36	309	1
OUTDOOR			
14.9011.050.12	QS-519	309	1

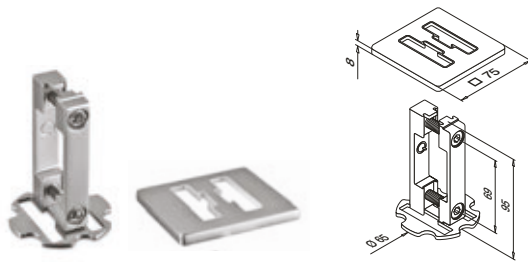

MOD 9012

Material	304	316	
INDOOR			
13.9012.050.12			1
OUTDOOR			
14.9012.050.12			1

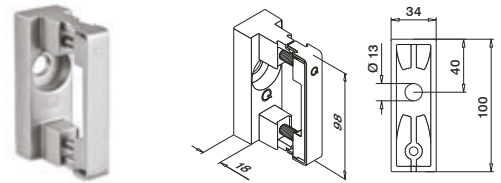

MOD 9021

Material	304	316	
INDOOR			
13.9021.050.12	QS-33	306	1
OUTDOOR			
14.9021.050.12	QS-32	306	1

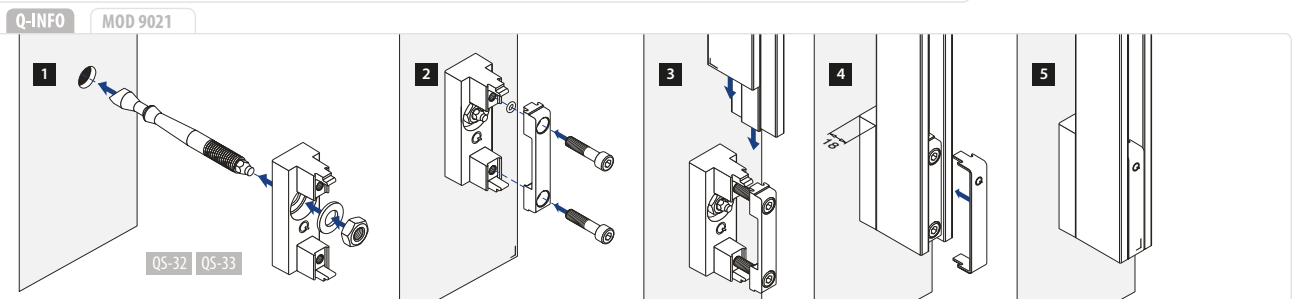
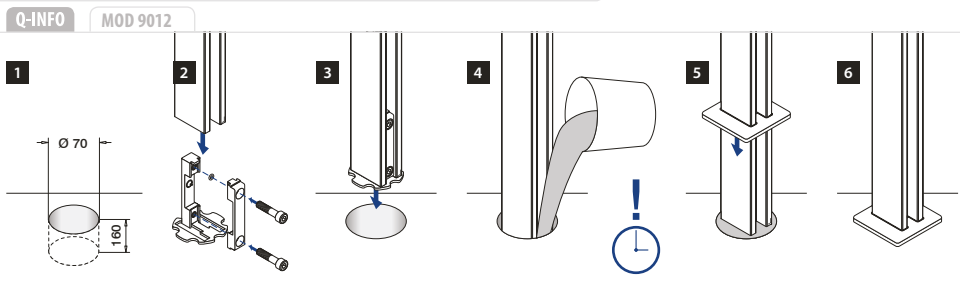
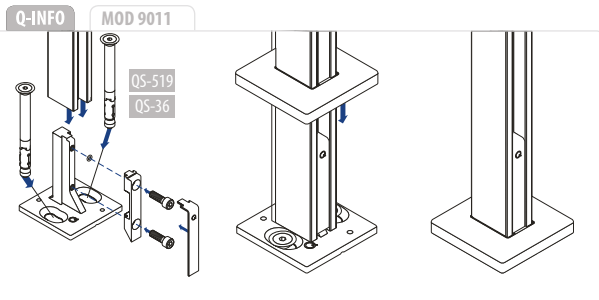

Q-INFO

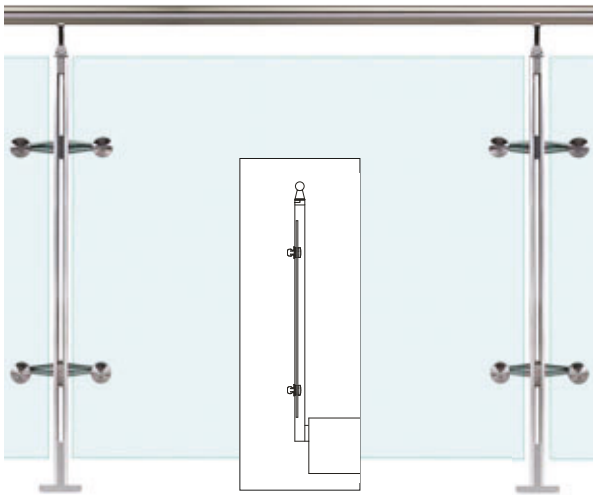

84 Glass adapters - Spider

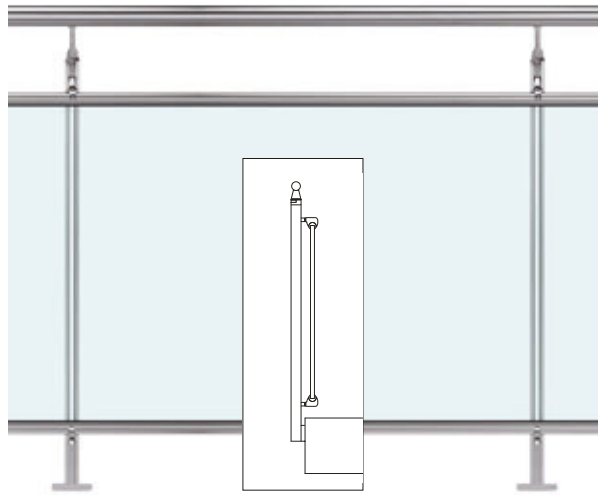

84 - 85 Glass Frame Tube

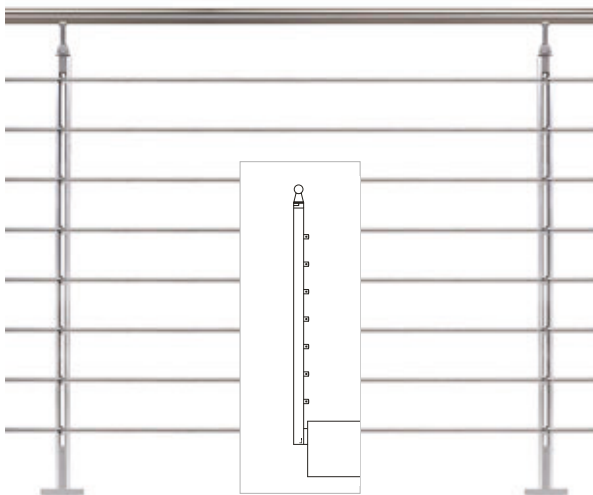

87 - 88 Bar

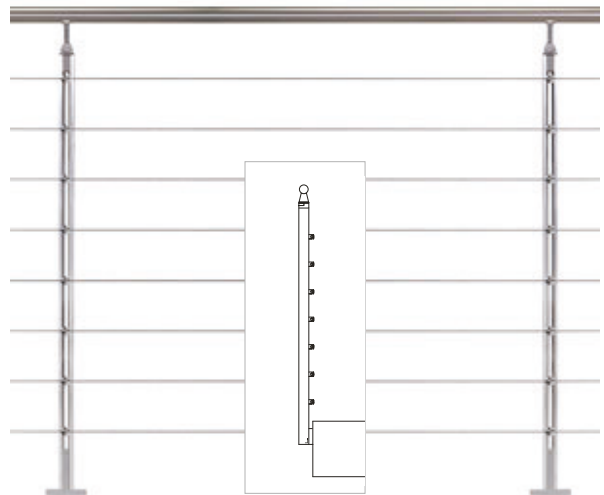

89 Cable

Q-INFO

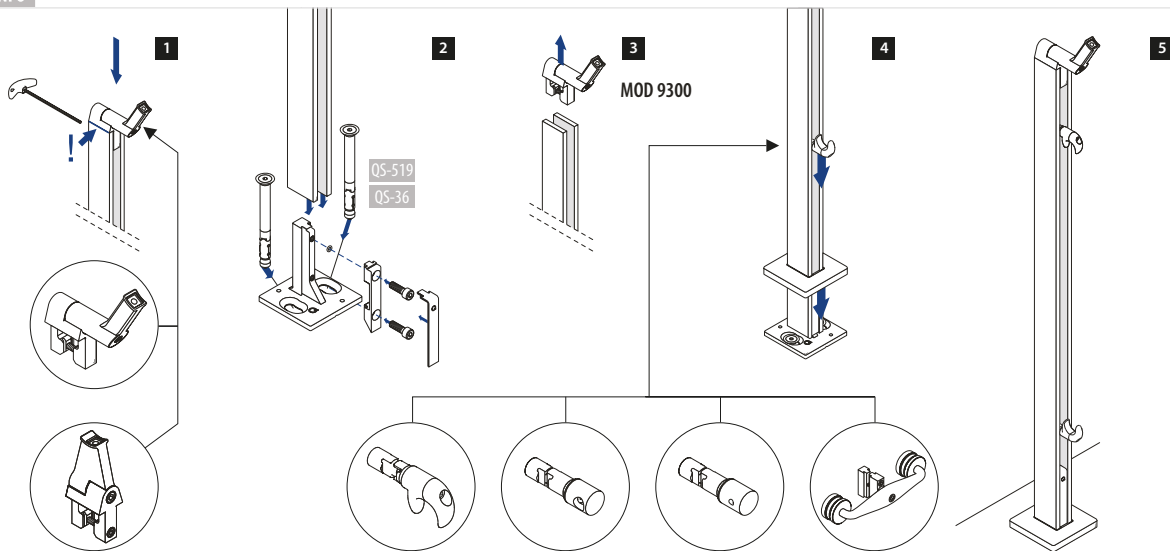

Infills

SATIN

QUICKRAIL® - Glass adapters - Spider

Quickrail® - glass

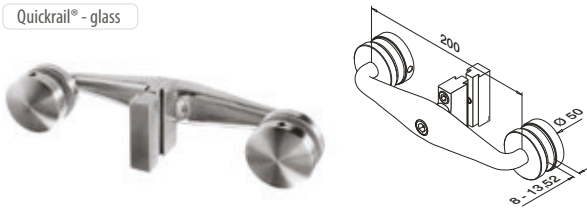

MOD 9110

304		
INDOOR		
13.9110.050.12	2	
316		
OUTDOOR		
14.9110.050.12	2	



Quickrail® - glass

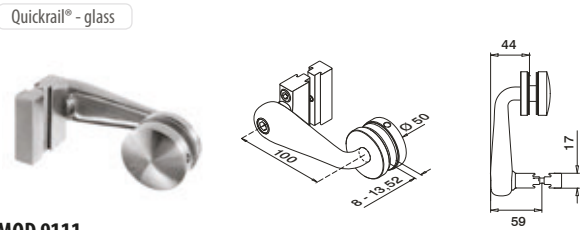

MOD 9111

304		
INDOOR		
13.9111.050.12	2	
316		
OUTDOOR		
14.9111.050.12	2	



Infills

SATIN

QUICKRAIL® - Glass Frame Tube - Brackets

Quickrail® - Glass Frame Tube



MOD 9860

304		
INDOOR	∅	
13.9860.050.12	30	2
316		
OUTDOOR	∅	
14.9860.050.12	30	2



Q-INFO

MOD 9110 / 9111

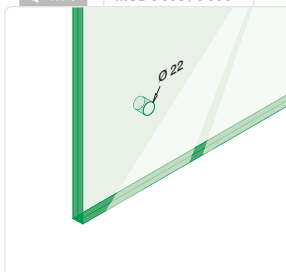

Infills

SATIN

QUICKRAIL® - Glass Frame Tube

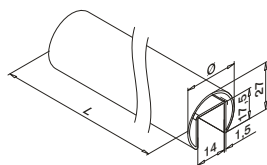

MOD 6925 / 6920 - Ø 30 mm

304

INDOOR	Ø	
13.6925.030.12	30	L = 2500 mm
13.6920.030.12	30	L = 5000 mm

316

OUTDOOR	Ø	
14.6925.030.12	30	L = 2500 mm
14.6920.030.12	30	L = 5000 mm

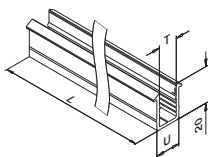

MOD 50 - Ø 30 mm

Accessories

	U	T	
19.5030.008.00	14	8 + 8,76	L = 5000 mm
19.5030.010.00	14	10 + 10,76	L = 5000 mm

Infills

QUICKRAIL® - Glass Frame Tube - Q-glass

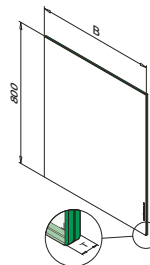

MOD 08 - VSG (ESG) - H=800 mm



Glass	B (mm)	T
50.0801.042.00	100	8,76 (4 - 0,76 - 4)
50.0802.042.00	200	8,76 (4 - 0,76 - 4)
50.0803.042.00	300	8,76 (4 - 0,76 - 4)
50.0804.042.00	400	8,76 (4 - 0,76 - 4)
50.0805.042.00	500	8,76 (4 - 0,76 - 4)
50.0806.042.00	600	8,76 (4 - 0,76 - 4)
50.0807.042.00	700	8,76 (4 - 0,76 - 4)
50.0808.042.00	800	8,76 (4 - 0,76 - 4)
50.0809.042.00	900	8,76 (4 - 0,76 - 4)
50.0809.542.00	950	8,76 (4 - 0,76 - 4)
50.0810.042.00	1000	8,76 (4 - 0,76 - 4)
50.0815.042.00	1500	8,76 (4 - 0,76 - 4)



* VSG (2x ESG) : Laminated glass from toughened glass

Q-INFO

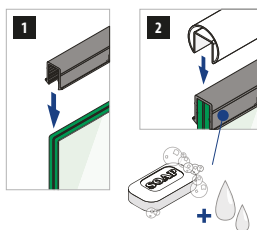
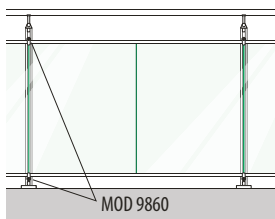

Q-INFO

Calculation

$$H (m) \times B (m) \times 2,5 \times T_g (mm) = kg$$

Example

H	B	T
1,1 m	1,0 m	16 mm
1,1 x 1,0 x 2,5 x 16 = 44,00 kg		

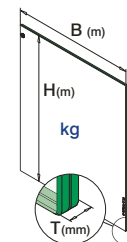

Q-INFO

MOD 6925 / 6920

Calculation basis for cap rails

calculated by ONDRA

	Ø (mm)	A (cm ²)	I _x (cm ⁴)	I _y (cm ⁴)	W _x (cm ³)	W _y (cm ³)	M (kg/m)	R _{p0,2} (kN/cm ²)	R _m (kN/cm ²)
13.6920.030.12 / 13.6925.030.12	30	1,82	1,08	1,66	0,78	1,11	1,46	23	54
14.6920.030.12 / 14.6925.030.12	30	1,82	1,08	1,66	0,78	1,11	1,46	24	53

A = cross sectional area W_x / W_y = section modulus R_{p0,2} = permissible stress
 I_x / I_y = second moment of area M = weight R_m = minimum tensile strength

Q-INFO

MOD 08xx

VSG: Laminated glass

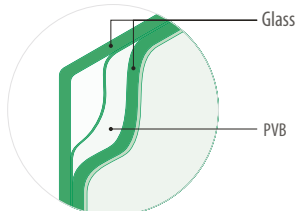
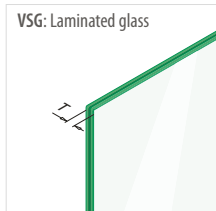

- Smooth
- Rounded edge
- Polished
- Rounded corners

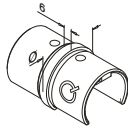
**MOD 6790**

304			
INDOOR	Ø		
13.6790.030.12	30 x 1,5		2
316			
OUTDOOR	Ø		
14.6790.030.12	30 x 1,5		2

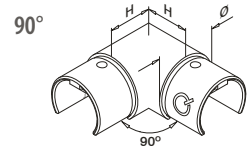
**MOD 6313**

304			
INDOOR	Ø	H	
13.6313.030.12	30 x 1,5	25	2
316			
OUTDOOR	Ø	H	
14.6313.030.12	30 x 1,5	25	2



Downwards

25-55°

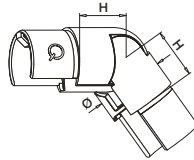
**MOD 6302**

304			
INDOOR	Ø	H	
13.6302.030.12	30 x 1,5	25	2
316			
OUTDOOR	Ø	H	
14.6302.030.12	30 x 1,5	25	2



Upwards

25-55°

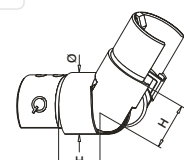
**MOD 6312**

304			
INDOOR	Ø	H	
13.6312.030.12	30 x 1,5	25	2
316			
OUTDOOR	Ø	H	
14.6312.030.12	30 x 1,5	25	2

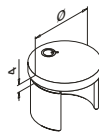
**MOD 6732**

304			
INDOOR	Ø		
13.6732.030.12	30 x 1,5		2
316			
OUTDOOR	Ø		
14.6732.030.12	30 x 1,5		2



Q-INFO



Q-21
Q-glue
50 ml
19.1331.000.00



Consumption per bonding ca. 1 ml

Q-Video www.q-railing.com

Quickrail® - bar

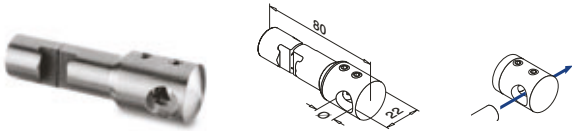
**MOD 9100****304**

INDOOR	Ø	
13.9100.050.12	12	4

316

OUTDOOR	Ø	
14.9100.050.12	12	4

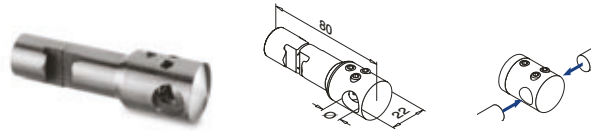

Quickrail® - bar

**MOD 9101****304**

INDOOR	Ø	
13.9101.050.12	12	4

316

OUTDOOR	Ø	
14.9101.050.12	12	4



For more information, please visit our website: www.q-railing.com

Q-INFO**Q-23**Q-cleaner
300 ml

19.0601.000.00

Q-INFO**Q-22**Q-ultra-clean
500 ml

19.0610.000.00

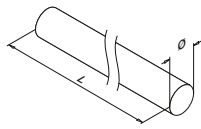

**MOD 8925 / 0900 - Ø 12 mm****304**

INDOOR	Ø	
13.8925.012.12	12	L = 2500 mm
13.0900.012.12	12	L = 5000 mm

316

OUTDOOR	Ø	
14.8925.012.12	12	L = 2500 mm
14.0900.012.12	12	L = 5000 mm

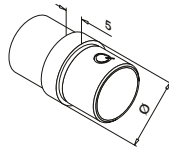
**MOD 0790****304**

INDOOR	Ø	
13.0790.112.12	12 x 1,0	4

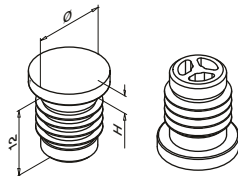

ABS plastic

**MOD 5729 - EASY HIT®**

ABS plastic Stainless steel effect

INDOOR	Ø	
24.5729.112.19	12 x 1,0	4

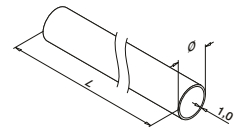
**MOD 8925 / 0900 - Ø 12 mm****304**

INDOOR	Ø	
13.8925.112.12	12	L = 2500 mm
13.0900.112.12	12	L = 5000 mm

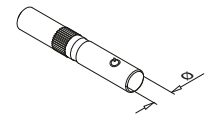
**MOD 5792 - EASY HIT®****304**

INDOOR	Ø	
13.5792.112.00	for 12 x 1,0	4

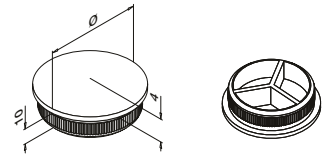

International Design Model Protection

**MOD 5729 - EASY HIT®****304**

INDOOR	Ø	
13.5729.112.12	12 x 1,0	4



Q-INFO

MOD 8925 / 0900

Calculation basis for bars

	Ø (mm)	A (cm ²)	I _x =I _y (cm ⁴)	W _x =W _y (cm ³)	M (kg/m)	R _{p0,2} (kN/cm ²)	R _m (kN/cm ²)
13.8925.012.12 / 13.0900.012.12	12	1,13	0,10	0,17	0,88	23	54
14.8925.012.12 / 14.0900.012.12	12	1,13	0,10	0,17	0,88	24	53

Calculation basis for tubes

	Ø (mm)	A (cm ²)	I _x =I _y (cm ⁴)	W _x =W _y (cm ³)	M (kg/m)	R _{p0,2} (kN/cm ²)	R _m (kN/cm ²)
13.8925.112.12 / 13.0900.112.12	12 x 1,0	0,34	0,09	0,12	0,28	23	54

calculated by **ONDRA**

A = cross sectional area
 I_x / I_y = second moment of area
 W_x / W_y = section modulus
 M = weight
 R_{p0,2} = permissible stress
 R_m = minimum tensile strength

QUICKRAIL® - Cable system - Ø 3,2 mm

Quickrail® - cable

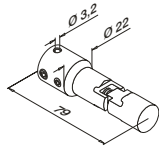

Centre

MOD 9450

304	
INDOOR	
13.9450.050.12	4
316	
OUTDOOR	
14.9450.050.12	4



Quickrail® - cable

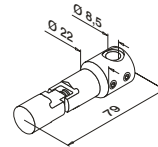

Left

MOD 9452

304	
INDOOR	
13.9452.050.12	4
316	
OUTDOOR	
14.9452.050.12	4



Quickrail® - cable

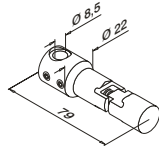

Right

MOD 9453

304	
INDOOR	
13.9453.050.12	4
316	
OUTDOOR	
14.9453.050.12	4



QUICKRAIL® - Cable system - Ø 3,2 mm

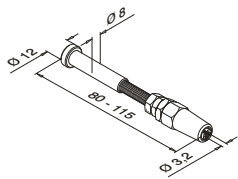

MOD 7500

304	
INDOOR	
13.7500.003.12	4
316	
OUTDOOR	
14.7500.003.12	4



Ø 3,2 mm = (1 x 19)

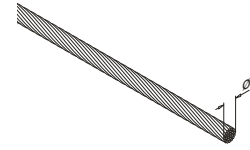

MOD 7900

304	
INDOOR	
13.7900.003.12	Ø 10 m
13.7900.053.12	Ø 50 m
13.7900.103.12	Ø 100 m
316	
OUTDOOR	
14.7900.003.12	Ø 10 m
14.7900.053.12	Ø 50 m
14.7900.103.12	Ø 100 m

Q-INFO

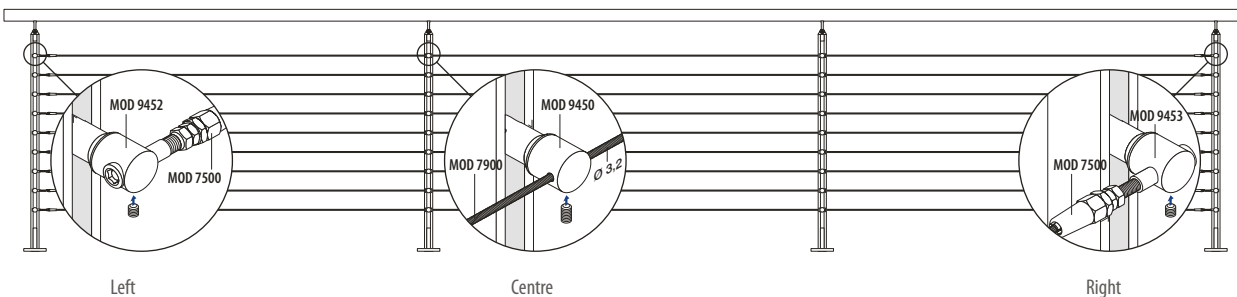

QUICKRAIL® - Handrail brackets (adjustable)

Quickrail® - tube

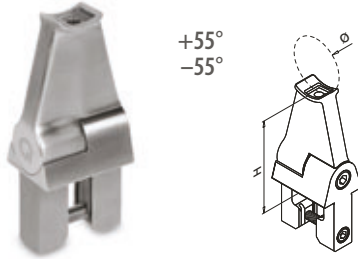

MOD 9310

304				
INDOOR	Ø	H		
13.9310.042.12	42,4	75	QS-54	303 2
13.9310.048.12	48,3	75	QS-54	303 2
316				
OUTDOOR	Ø	H		
14.9310.042.12	42,4	75	QS-70	303 2
14.9310.048.12	48,3	75	QS-70	303 2



Quickrail® - tube

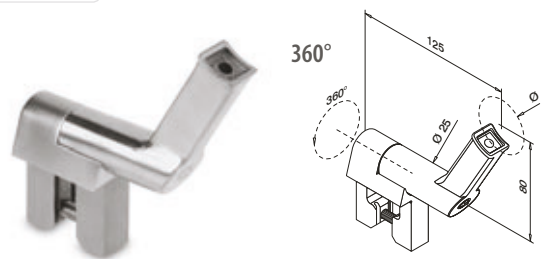

MOD 9300

304				
INDOOR	Ø			
13.9300.042.12	42,4	QS-25	303	2
13.9300.048.12	48,3	QS-25	303	2
316				
OUTDOOR	Ø			
14.9300.042.12	42,4	QS-71	303	2
14.9300.048.12	48,3	QS-71	303	2



MOD 8925, 0900
196, 198



Q-INFO

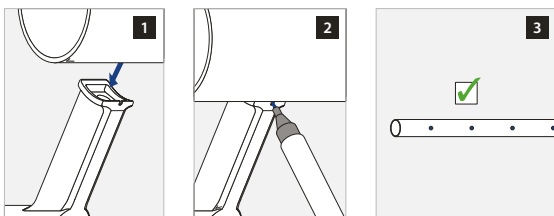



LINEAR LINE

Linear Line is a complete system based on rigid lines and flat shapes, with no visible screws to distract the eye. Its stainless steel fittings are clamped onto the adapters through a simple mechanism, while the adapters are simply pushed onto the baluster post itself. Choose vertical bar holders or glass with either glass clamps or glass holders as your filling, to give your railing the perfect end result.



GOEDKEURING
VOLGENS BB2012
EUROCODES
1990-1999:2011
NEN2608

**STATISCHE
BERECHNUNG**
GEMÄß TRAV

Posts

SATIN

LINEAR LINE - Baluster posts



Top mount

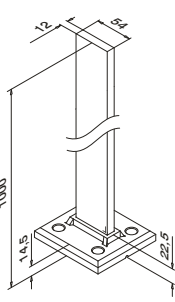
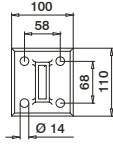
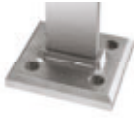

Infloor
Fascia mount

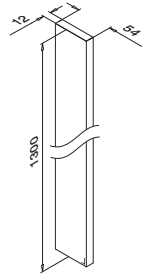

MOD 0547

316

OUTDOOR

14.0547.054.12

54 x 12

QS-559

308

1



MOD 0548

316

OUTDOOR

14.0548.054.12

54 x 12

1



Posts

SATIN

LINEAR LINE - Cover caps for baluster posts



Top mount

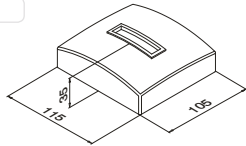

Infloor

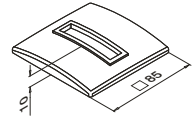

MOD 9013

316

OUTDOOR

14.9013.051.12

2



MOD 9012

316

OUTDOOR

14.9012.051.12

2



Q-INFO

MOD 0547 / 9013

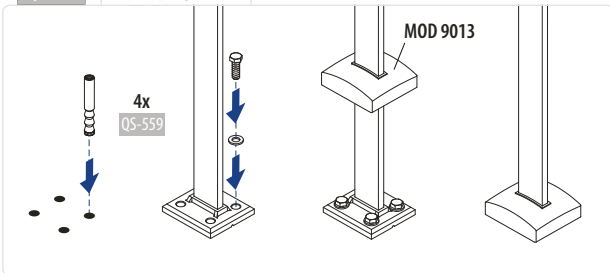

Q-INFO

MOD 0548 / 9012

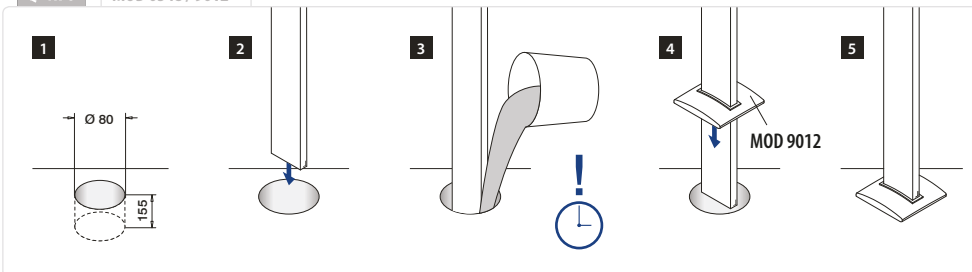

Q-INFO



LINEAR LINE - Flanges for baluster posts

Top mount

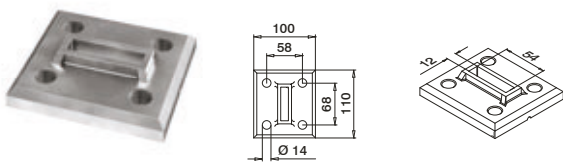

MOD 3503

316

OUTDOOR

14.3503.054.00

QS-559 308

2

NEW



LINEAR LINE - Baluster brackets

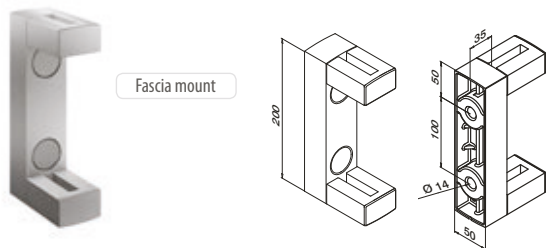

Fascia mount

MOD 9022

316

OUTDOOR

14.9022.051.12

54 x 12

QS-559 308

1

NEW



International Design Model Protection

Q-INFO

MOD 9022

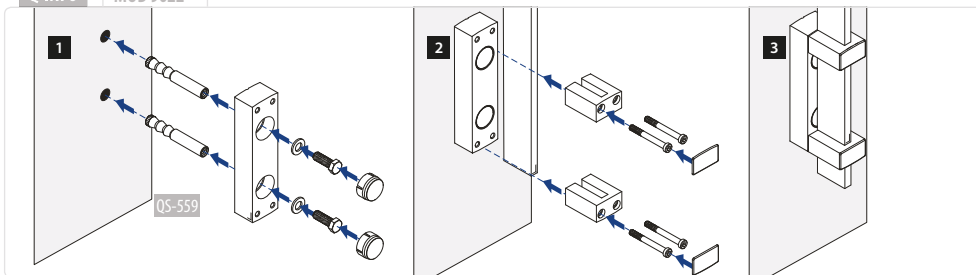

Q-INFO

MOD 0547

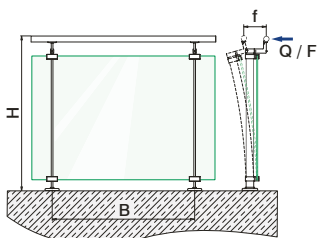

Linear Line (Static calculation)

MOD	Country	Q	F	Indoor		Outdoor		
				B (max)	B (max)	wind	H (max)	f
0547.054	Germany	0,50 kN/m	-	1400 mm	1150 mm	0,70* kN/m ²	1100 mm	< 25 mm
	France	0,50 kN/m	1,00 kN/1 min.	1100 mm	1100 mm	1,95 kN/m ²	1000 mm	< 20 mm
	Germany	1,00 kN/m	-	850 mm	800 mm	0,70* kN/m ²	1100 mm	< 25 mm
	France	0,80 kN/m	1,00 kN/5 min.	1100 mm	1100 mm	1,95 kN/m ²	1000 mm	< 20 mm

* Line load and wind force combined

Q-INFO

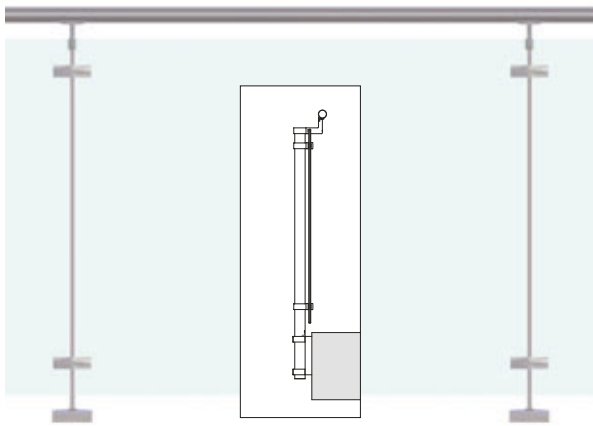

96 Glass clamps - MOD 29

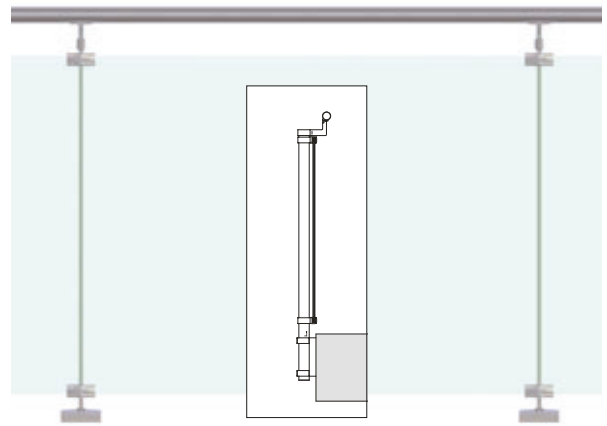

95 Glass holders - MOD 55

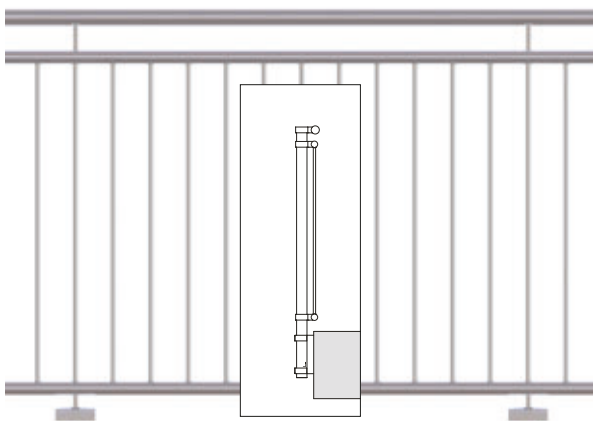

98 Picket rail / vertical bar filling

Q-INFO

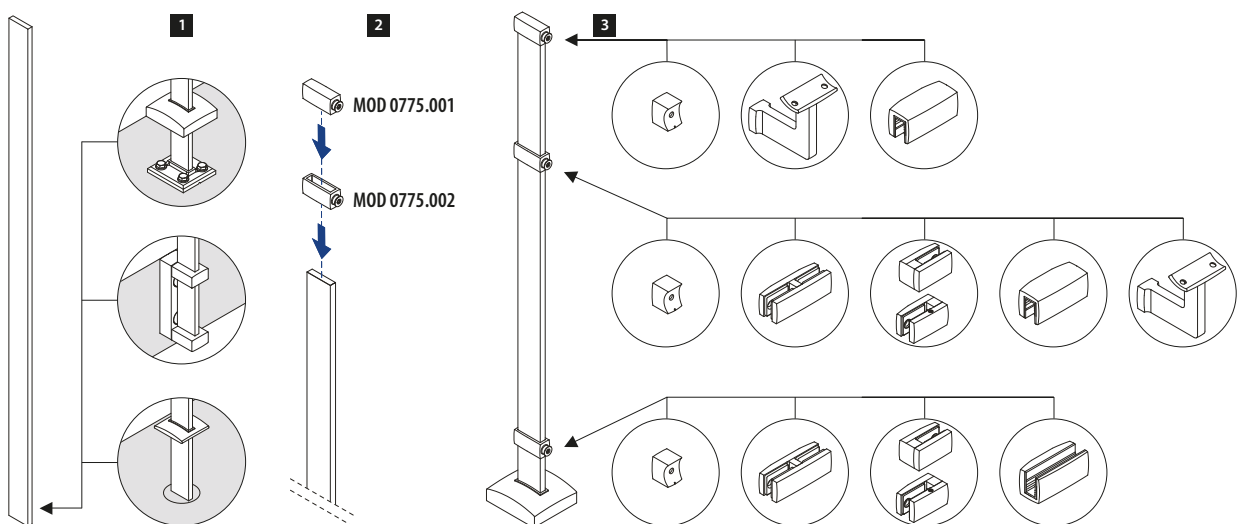

Infills

SATIN

LINEAR LINE - Adapters

Top

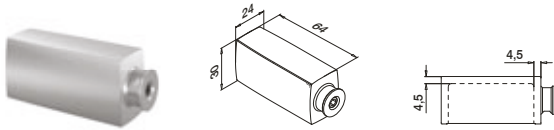

MOD 0775

316

OUTDOOR

14.0775.001.12



2

NEW



International Design Model Protection

Intermediate

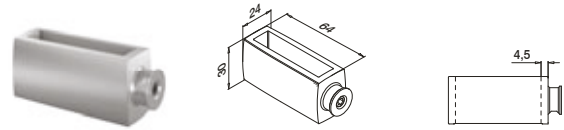

MOD 0775

316

OUTDOOR

14.0775.002.12



2

NEW



International Design Model Protection

Infills

SATIN

LINEAR LINE - Glass holders

Top

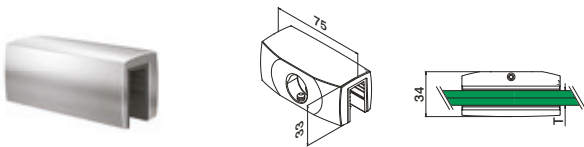

MOD 55

316

OUTDOOR

14.5508.001.12

8 - 8,76 (4 - 0,76 - 4)



2

14.5544.001.12

9,52 (4 - 1,52 - 4)

2

14.5510.001.12

10 - 10,76 (5 - 0,76 - 5)

2

14.5554.001.12

11,52 (5 - 1,52 - 5)

2

14.5512.001.12

12 - 12,76 (6 - 0,76 - 6)

2

14.5564.001.12

13,52 (6 - 1,52 - 6)

2

NEW



International Design Model Protection

Bottom

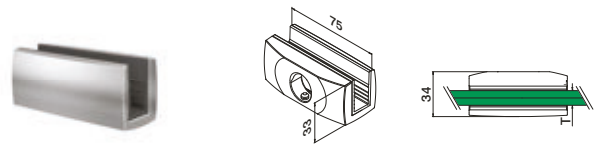

MOD 55

316

OUTDOOR

14.5508.002.12

8 - 8,76 (4 - 0,76 - 4)



2

14.5544.002.12

9,52 (4 - 1,52 - 4)

2

14.5510.002.12

10 - 10,76 (5 - 0,76 - 5)

2

14.5554.002.12

11,52 (5 - 1,52 - 5)

2

14.5512.002.12

12 - 12,76 (6 - 0,76 - 6)

2

14.5564.002.12

13,52 (6 - 1,52 - 6)

2

NEW



International Design Model Protection

Q-INFO

MOD 0775

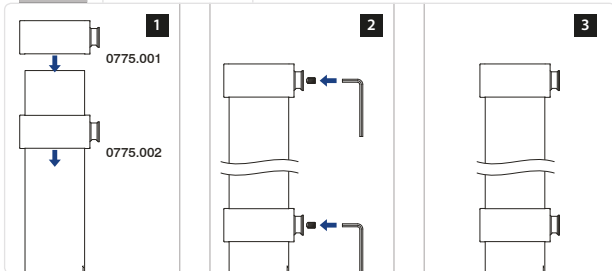

Q-INFO

MOD 55xx.002

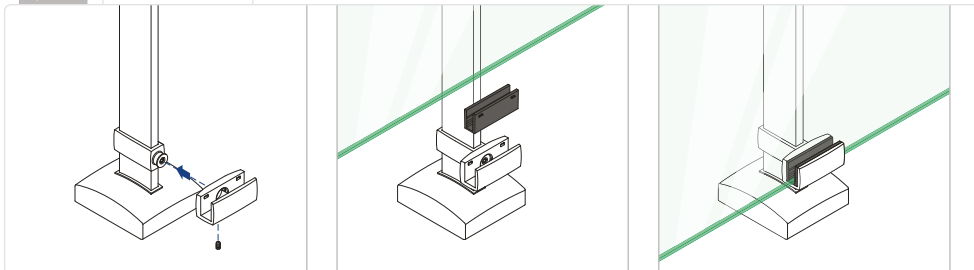

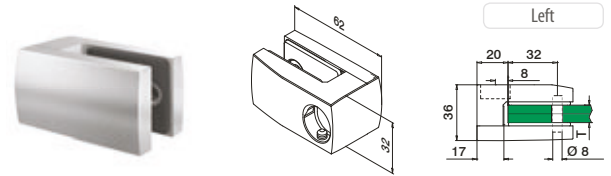
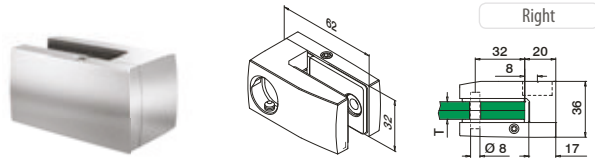

MOD 29

MONO	316	OUTDOOR	T	
14.2908.001.12	8			2
14.2910.001.12	10			2
14.2912.001.12	12			2

LAM.	316	OUTDOOR	T	
14.2909.001.12	8,76	(4 - 0,76 - 4)		2
14.2944.001.12	9,52	(4 - 1,52 - 4)		2
14.2911.001.12	10,76	(5 - 0,76 - 5)		2
14.2954.001.12	11,52	(5 - 1,52 - 5)		2
14.2913.001.12	12,76	(6 - 0,76 - 6)		2
14.2964.001.12	13,52	(6 - 1,52 - 6)		2



International Design Model Protection

MOD 29

MONO	316	OUTDOOR	T	
14.2908.002.12	8			2
14.2910.002.12	10			2
14.2912.002.12	12			2

LAM.	316	OUTDOOR	T	
14.2909.002.12	8,76	(4 - 0,76 - 4)		2
14.2944.002.12	9,52	(4 - 1,52 - 4)		2
14.2911.002.12	10,76	(5 - 0,76 - 5)		2
14.2954.002.12	11,52	(5 - 1,52 - 5)		2
14.2913.002.12	12,76	(6 - 0,76 - 6)		2
14.2964.002.12	13,52	(6 - 1,52 - 6)		2



International Design Model Protection

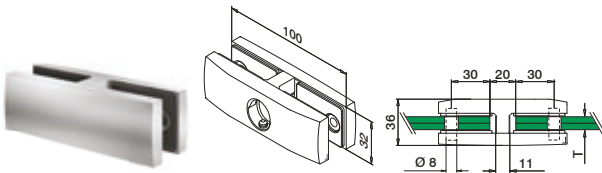

MOD 29

MONO	316	OUTDOOR	T	
14.2908.000.12	8			2
14.2910.000.12	10			2
14.2912.000.12	12			2

LAM.	316	OUTDOOR	T	
14.2909.000.12	8,76	(4 - 0,76 - 4)		2
14.2944.000.12	9,52	(4 - 1,52 - 4)		2
14.2911.000.12	10,76	(5 - 0,76 - 5)		2
14.2954.000.12	11,52	(5 - 1,52 - 5)		2
14.2913.000.12	12,76	(6 - 0,76 - 6)		2
14.2964.000.12	13,52	(6 - 1,52 - 6)		2



International Design Model Protection

Accessories

Security pins for glass clamps



Security pins for glass clamps

MOD 5015

Accessories	L	
19.5015.022.00	22	4

Q-INFO MOD 9329

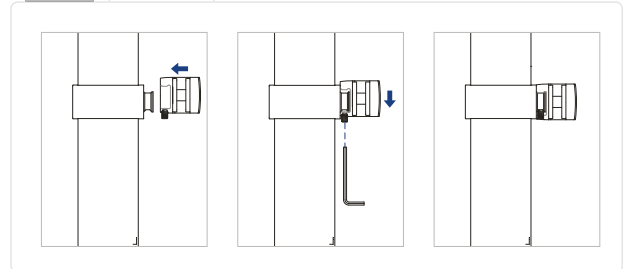

Q-INFO MOD 29xx.000

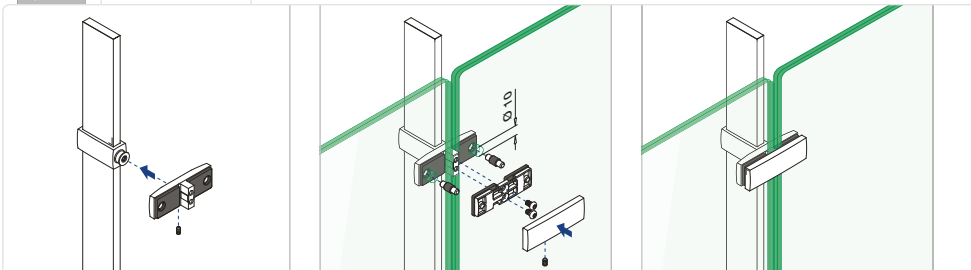

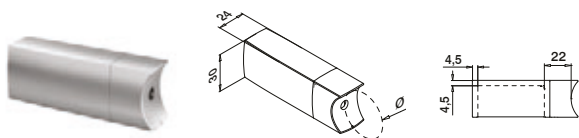

MOD 9328

316

OUTDOOR

14.9328.033.12	∅ 33,7	2
----------------	--------	---

NEW

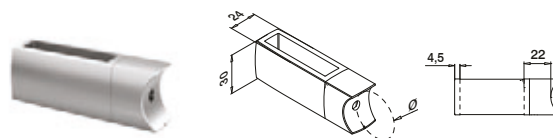

MOD 9329

316

OUTDOOR

14.9329.033.12	∅ 33,7	2
----------------	--------	---

NEW



Q-TUBE



MOD 0900 / 8925

∅ 12 mm

304

INDOOR

13.8925.012.12	∅ 12	L = 2500 mm
13.0900.012.12	∅ 12	L = 5000 mm



Q-TUBE



MOD 0900 / 8925

∅ 12 mm

304

INDOOR

13.8925.112.12	∅ 12	L = 2500 mm
13.0900.112.12	∅ 12	L = 5000 mm

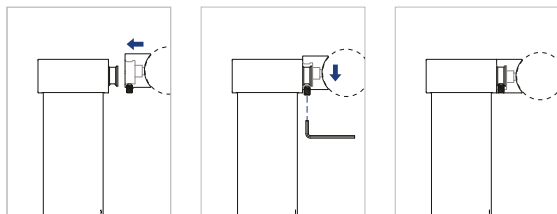

Calculation basis for bars

	∅ (mm)	A (cm ²)	I _x =I _y (cm ⁴)	W _x =W _y (cm ³)	M (kg/m)	R _{p0,2} (kN/cm ²)	R _m (kN/cm ²)
13.0900.012.12 / 13.8925.012.12	12	1,13	0,10	0,17	0,89	23	54
14.0900.012.12 / 14.8925.012.12	12	1,13	0,10	0,17	0,89	24	53

Calculation basis for tubes

	∅ (mm)	A (cm ²)	I _x =I _y (cm ⁴)	W _x =W _y (cm ³)	M (kg/m)	R _{p0,2} (kN/cm ²)	R _m (kN/cm ²)
13.0900.112.12 / 13.8925.112.12	12 x 1,0	0,34	0,05	0,09	0,27	23	54

calculated by ONDRA

- A = cross sectional area
- I_x / I_y = second moment of area
- W_x / W_y = section modulus
- M = weight
- R_{p0,2} = permissible stress
- R_m = minimum tensile strength

Infills

SATIN

Tube for bar filling (picket rail)

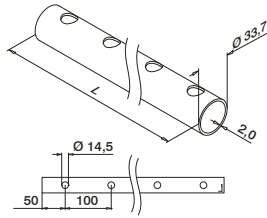

MOD 8926

Ø 33,7 mm

304

INDOOR

13.8926.233.12

L = 2500 mm

NEW

Infills

RAW

EASY HIT® - Connectors

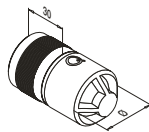

MOD 5792 - EASY HIT®

304

INDOOR

13.5792.233.00

for 33,7 x 2,0

2

NEW



International Design Model Protection

Infills

STAINLESS ST. EFFECT

Adapters for bar filling (picket rail)

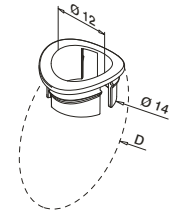

MOD 0521

ABS plastic

OUTDOOR

D

50

24.0521.033.19

33,7

50

NEW



208 - 209

Q-INFO

MOD 8926

Calculation basis for tubes

	Ø (mm)	A (cm ²)	I _x (cm ⁴)	I _y (cm ⁴)	W _x (cm ³)	W _y (cm ³)	M (kg/m)	R _{p0,2} (kN/cm ²)	R _m (kN/cm ²)
13.8926.233.12	33,7 x 2,0	1,69	2,46	1,68	1,46	1,00	1,54	23	54

A = cross sectional area
I_x / I_y = second moment of area
W_x / W_y = section modulus

M = weight
R_{p0,2} = permissible stress
R_m = minimum tensile strength

For more information, please visit our website: www.q-railing.com

Q-INFO

MOD 8926 / 0521

1

MOD 0521

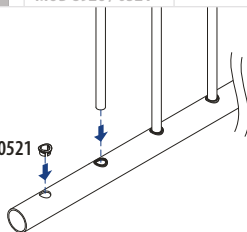

2

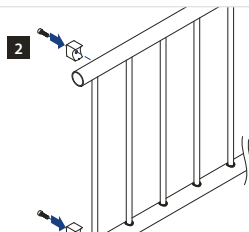

3

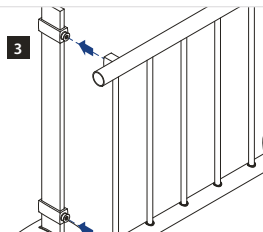

4

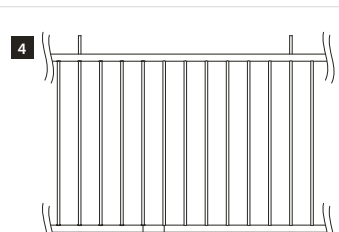

LINEAR LINE - Handrail brackets (adjustable)

Top

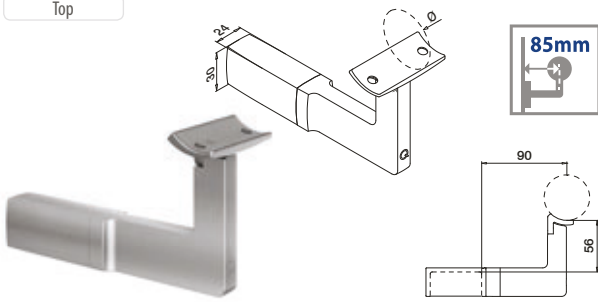

MOD 9325

316

OUTDOOR	∅		
14.9325.042.12	42,4	QS-89	303
14.9325.048.12	48,3	QS-89	303

NEW



Intermediate

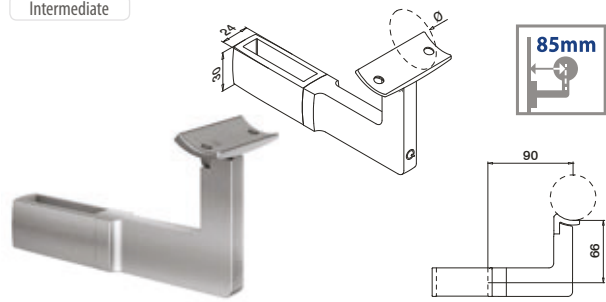

MOD 9326

316

OUTDOOR	∅		
14.9326.042.12	42,4	QS-89	303
14.9326.048.12	48,3	QS-89	303

NEW



For stairs

Adjustable

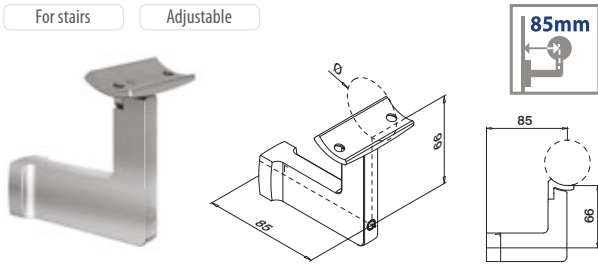

MOD 4819

316

OUTDOOR	∅		
14.4819.042.12	42,4	QS-89	303
14.4819.048.12	48,3	QS-89	303

NEW



127

International Design Model Protection

Handrails

SATIN

LINEAR LINE - Handrail adapters

Top

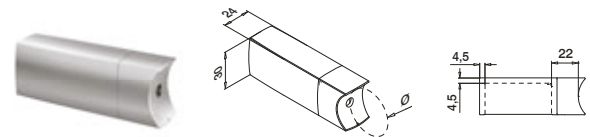

MOD 9327

316

OUTDOOR	∅	
14.9327.042.12	42,4	2

NEW



Handrails

SATIN

LINEAR LINE - Adapters for tube

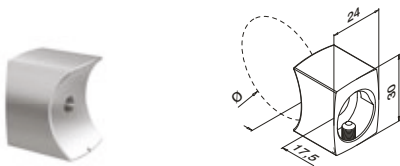

MOD 0629

316

OUTDOOR	∅		
14.0629.033.12	33,7	QS-53	303
14.0629.042.12	42,4	QS-53	303

NEW



95

International Design Model Protection

Q-INFO

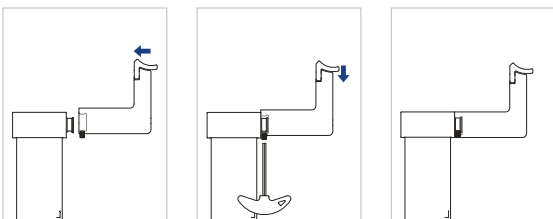

Q-INFO

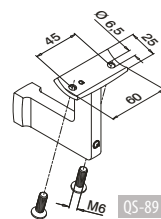

Q-INFO

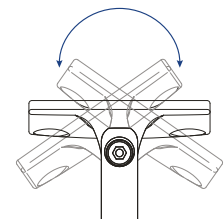

LINEAR LINE - Adapters

For wall mounting

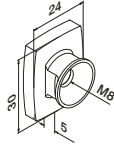

MOD 0775

316

OUTDOOR

14.0775.000.12



QS-2 302



4

NEW



Infills

SATIN

LINEAR LINE - Adapters

For flat tube

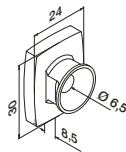

MOD 0774

316

OUTDOOR

14.0774.000.12



QS-16 303



4

NEW



For round tube

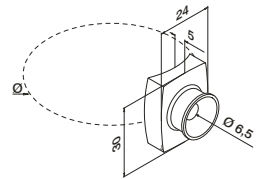
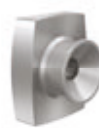

MOD 0774

316

OUTDOOR

14.0774.042.12

Ø



QS-16 303



4

14.0774.048.12

48,3

QS-16 303

4

NEW



Infills

SATIN

LINEAR LINE - Adapters for tube

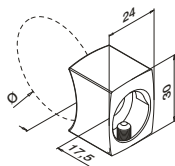

MOD 0629

316

OUTDOOR

14.0629.033.12

Ø



QS-53 303



4

14.0629.042.12

42,4

QS-53 303

4

NEW



International Design Model Protection

Q-INFO

MOD 0774

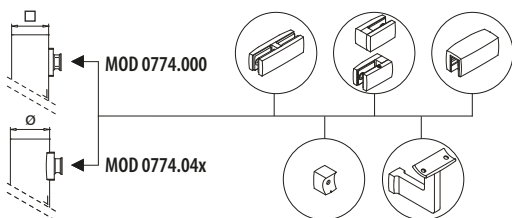

Q-INFO

MOD 0775

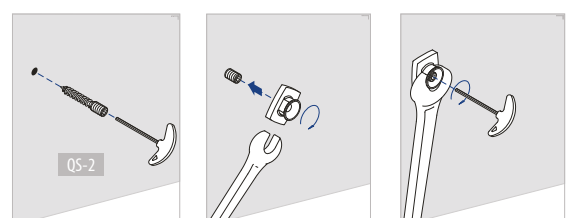



SQUARE LINE® 40x40

The sharp lines and corners of this baluster system will transform your designs with straighter and more modern-looking components. Because of the modularity of all Q-railing systems you can even combine the Square Line®'s components with those of any other Q-railing system to create a completely unique look. Infill choices include cables, glass with glass clamps or glass adapters, bars or even a web system.

**STATISCHE
BERECHNUNG
GEMÄß TRAV**

**APPROVED
to BS 6180**



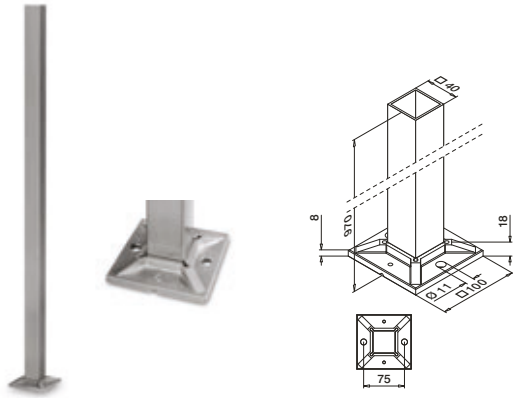

MOD 4913

304			
INDOOR			
13.4913.040.12	40 x 40 x 2,0	Q5-59 310	1
316			
OUTDOOR			
14.4913.040.12	40 x 40 x 2,0	Q5-58 310	1

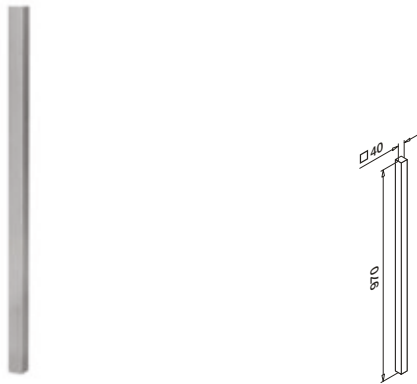

MOD 4901

304			
INDOOR			
13.4901.040.12	40 x 40 x 2,0		1



MOD 4511

304			
INDOOR		H	
13.4511.040.12	108	25	2
316			
OUTDOOR		H	
14.4511.040.12	108	25	2

MOD 4512

304			
INDOOR		H	
13.4512.040.12	93	22	2

Q-INFO MOD 4913 / 4901

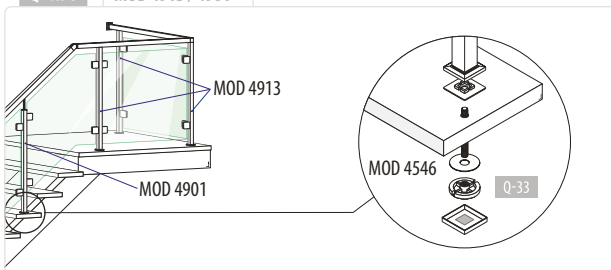



SQUARE LINE® 40x40 - Base flanges for glue connection

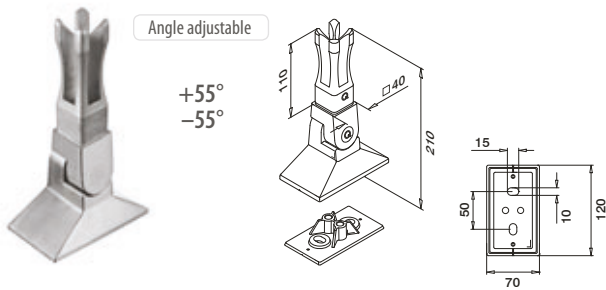

MOD 4943

304			
INDOOR	□	QS-63	307
13.4943.040.12	40 x 40	1	1
316			
OUTDOOR	□	QS-62	307
14.4943.040.12	40 x 40	1	1



International Design Model Protection

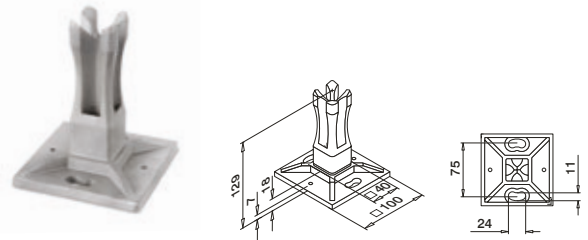

MOD 4942

304			
INDOOR	□	QS-59	310
13.4942.040.00	40 x 40	2	2
316			
OUTDOOR	□	QS-58	310
14.4942.040.00	40 x 40	2	2



International Design Model Protection

SQUARE LINE® 40x40 - Stair flanges for glue connection

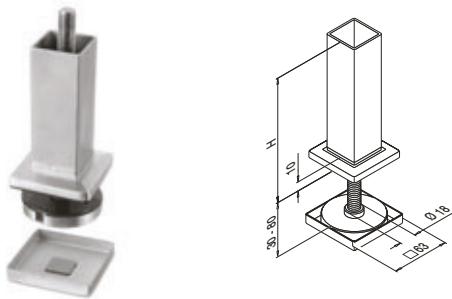

MOD 4546

304			
INDOOR	□	H	□
13.4546.040.12	40 x 40	100	1



MOD 4511

304			
INDOOR	□	H	□
13.4511.040.12	108	25	2
316			
OUTDOOR	□	H	□
14.4511.040.12	108	25	2

Q-INFO

MOD 4546

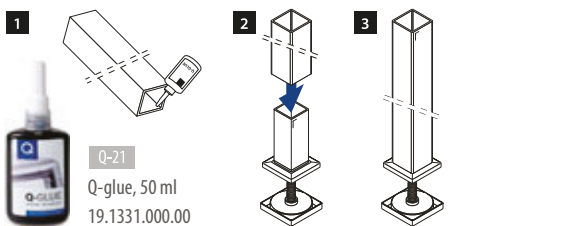

Q-21
Q-glue, 50 ml
19.1331.000.00

Q-INFO

MOD 4942 / 4901

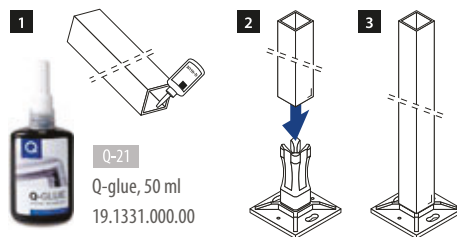

Q-21
Q-glue, 50 ml
19.1331.000.00

Q-INFO

MOD 4943

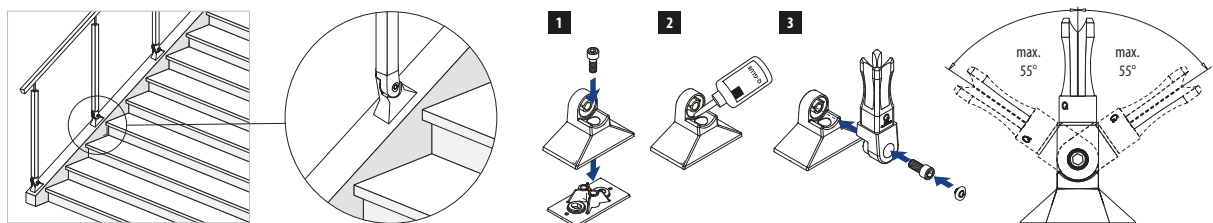



DESIGN
product

Q-railing®

SQUARE LINE® 40x40 - Baluster brackets

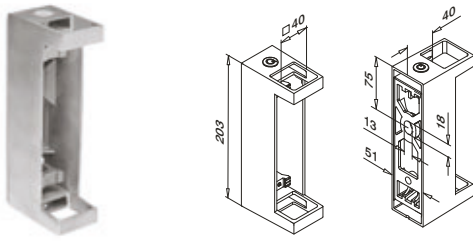

MOD 4558

304				
INDOOR	□			
13.4558.040.12	40 x 40	QS-33	306	1
316				
OUTDOOR	□			
14.4558.040.12	40 x 40	QS-32	306	1



Angle adjustable

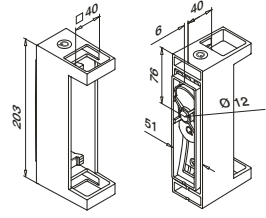

MOD 4556

316					
OUTDOOR	□				
14.4556.040.12	40 x 40	QS-73	307 / QS-552	303	1

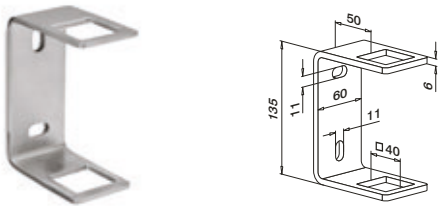

MOD 4550

304				
INDOOR	□			
13.4550.040.12	40 x 40	QS-65	306	1
316				
OUTDOOR	□			
14.4550.040.12	40 x 40	QS-64	306	1



Q-INFO MOD 4558

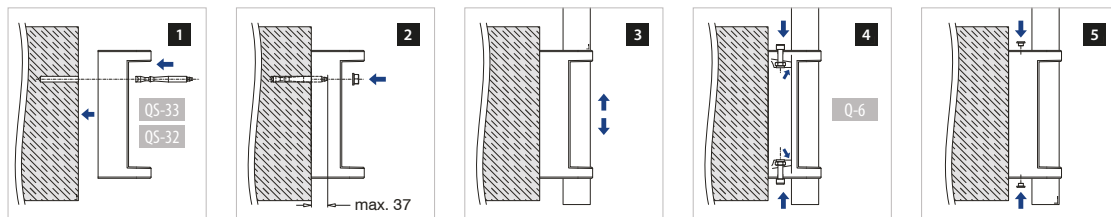

Q-INFO MOD 4556

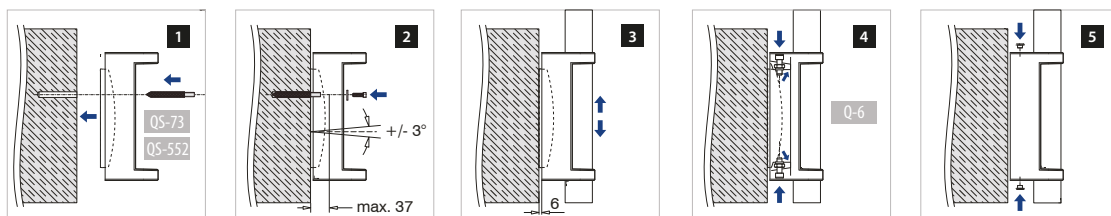

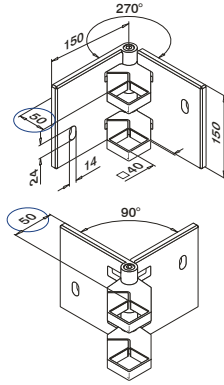

MOD 4555

304

INDOOR	□		
13.4555.040.12	40 x 40	QS-33	306

316

OUTDOOR	□		
14.4555.040.12	40 x 40	QS-32	306



Spirit level

□ 40, Ø 42,4, Ø 48,3 mm

MOD 0500

Accessories

	Q	
19.0500.000.00	Q-72	1

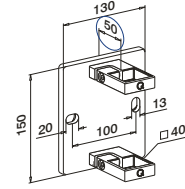

MOD 4551

304

INDOOR	□		
13.4551.040.12	40 x 40	QS-33	306

316

OUTDOOR	□		
14.4551.040.12	40 x 40	QS-32	306

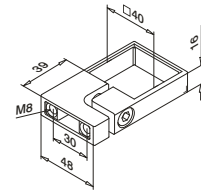

MOD 3507

304

INDOOR	□	
13.3507.040.12	40 x 40	2

316

OUTDOOR	□	
14.3507.040.12	40 x 40	2



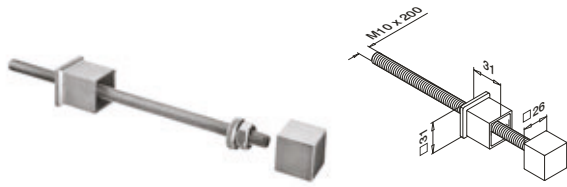

MOD 0550

304		
INDOOR	□	☐
13.0550.440.12	40 x 40	2
316		
OUTDOOR	□	☐
14.0550.440.12	40 x 40	2



Q-INFO

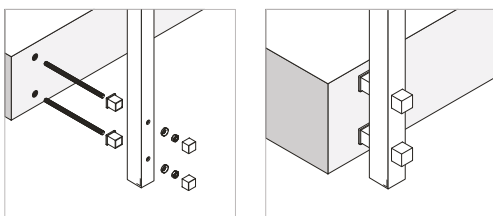

Infills

STAINL. STEEL EFF.

SQUARE LINE® 40x40 - Crossbar holders

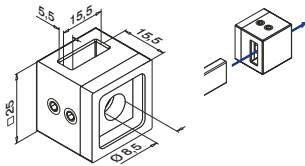

MOD 4820

Zinc	Stainless steel effect	
OUTDOOR		
10.4820.000.20	QS-20	303
		4



DESIGN product

International Design Model Protection

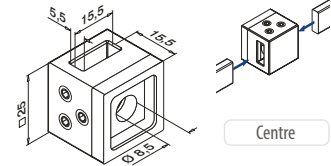

MOD 4821

Zinc	Stainless steel effect	
OUTDOOR		
10.4821.000.20	QS-20	303
		4



DESIGN product

International Design Model Protection

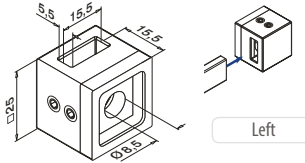

MOD 4822

Zinc	Stainless steel effect	
OUTDOOR		
10.4822.000.20	QS-20	303
		4



DESIGN product

International Design Model Protection

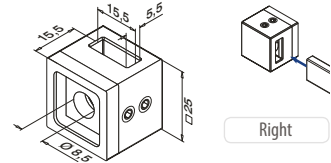

MOD 4823

Zinc	Stainless steel effect	
OUTDOOR		
10.4823.000.20	QS-20	303
		4



DESIGN product

International Design Model Protection

Infills

SATIN

SQUARE LINE® 40x40 - Bars

Q-TUBE

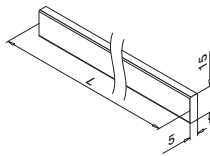

MOD 4925 / 4900

304		
INDOOR		
13.4925.015.12	15 x 5	L = 2500 mm
13.4900.015.12	15 x 5	L = 5000 mm
316		
OUTDOOR		
14.4925.015.12	15 x 5	L = 2500 mm
14.4900.015.12	15 x 5	L = 5000 mm



DESIGN product

L=5000mm

If you have a specific requirement for pre-assembled products please use our order forms on pages 324 - 336.

10.xxxx.xxx.20 = outdoor

Q-INFO

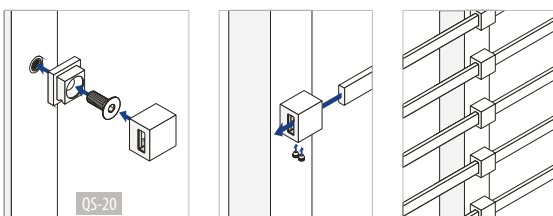

Q-INFO

MOD 4925 / 4900

Calculation basis for bars

calculated by ONDRA

	□ (mm)	A (cm ²)	I _x (cm ⁴)	I _y (cm ⁴)	W _x (cm ³)	W _y (cm ³)	M (kg/m)	R _{p0,2} (kN/cm ²)	R _m (kN/cm ²)
13.49xx.015.12	15 x 5	0,75	0,02	0,14	0,06	0,19	0,60	23	54
14.49xx.015.12	15 x 5	0,75	0,02	0,14	0,06	0,19	0,60	24	53

A = cross sectional area
 I_x / I_y = second moment of area
 W_x / W_y = section modulus
 M = weight
 R_{p0,2} = permissible stress
 R_m = minimum tensile strength

Wall - flat

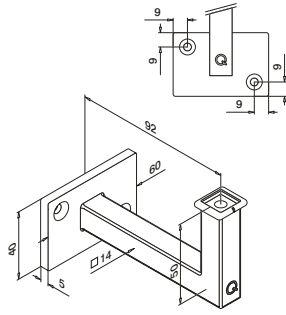
**MOD 4112****304****INDOOR**

13.4112.000.12	QS-5	302	QS-54	303	2
----------------	------	-----	-------	-----	---

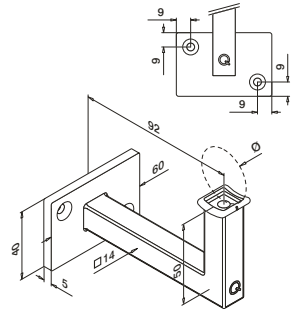

Wall - tube

**MOD 4112****304****INDOOR**

13.4112.042.12	42,4	QS-5	302	QS-54	303	2
----------------	------	------	-----	-------	-----	---

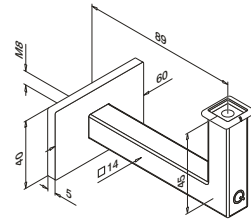

Wall - flat

**MOD 4111****304****INDOOR**

13.4111.000.12	QS-1	302	QS-54	303	2
----------------	------	-----	-------	-----	---

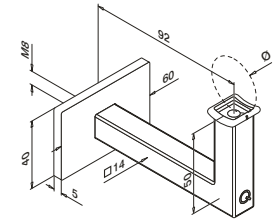

Wall - tube

**MOD 4111****304****INDOOR**

13.4111.042.12	42,4	QS-1	302	QS-54	303	2
----------------	------	------	-----	-------	-----	---

**MOD 4101****316****OUTDOOR**

14.4101.000.12	QS-2	302	QS-70	303	2
----------------	------	-----	-------	-----	---

**MOD 4101****316****OUTDOOR**

14.4101.042.12	42,4	QS-2	302	QS-70	303	2
----------------	------	------	-----	-------	-----	---

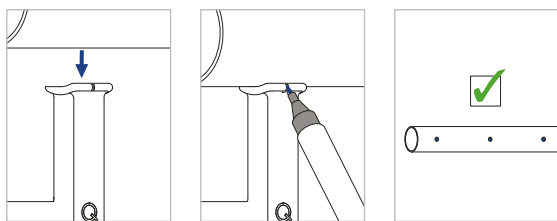
**Q-INFO****Q-INFO**

MOD 4111.042 / 4101.042

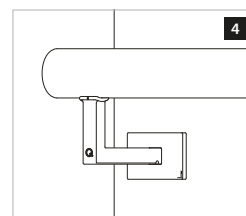
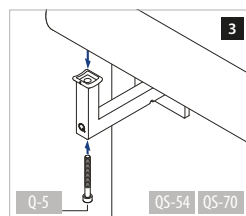
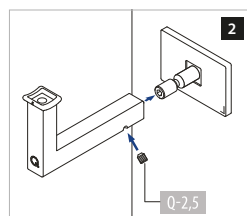
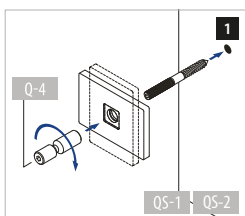

Tube - flat

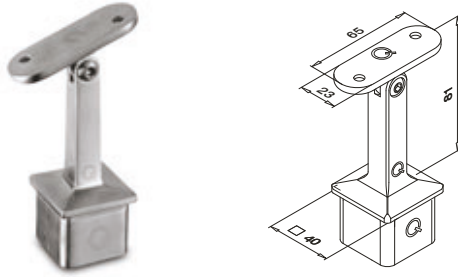
**MOD 4718** - □ 40 x 40 mm**304**

INDOOR		
13.4718.000.12	QS-12 303	2

316

OUTDOOR		
14.4718.000.12	QS-13 303	2

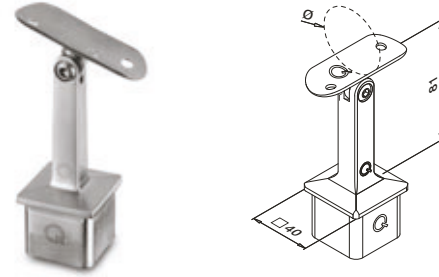

Tube - tube

**MOD 4718** - □ 40 x 40 mm**304**

INDOOR			
13.4718.042.12	∅ 42,4	QS-10 302	2
13.4718.048.12	∅ 48,3	QS-10 302	2

316

OUTDOOR			
14.4718.042.12	∅ 42,4	QS-11 302	2
14.4718.048.12	∅ 48,3	QS-11 302	2



Q-INFO

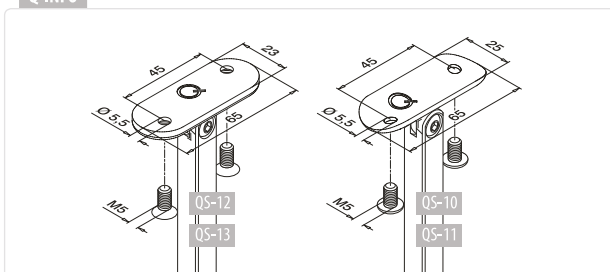

SQUARE LINE® 40x40 - Handrail adapters

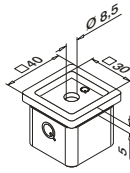

MOD 4727

304

INDOOR

13.4727.000.12

QS-26 19303



2



SQUARE LINE® - Handrail parts

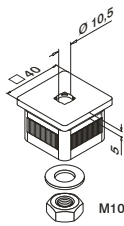

MOD 4733 - EASY HIT®

304

INDOOR

13.4733.040.12



2

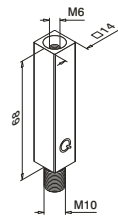

MOD 4811

304

INDOOR

13.4811.068.12



QS-48 19303



2



MOD 1800

195



MOD 1801

195



MOD 1802

195

Q-INFO

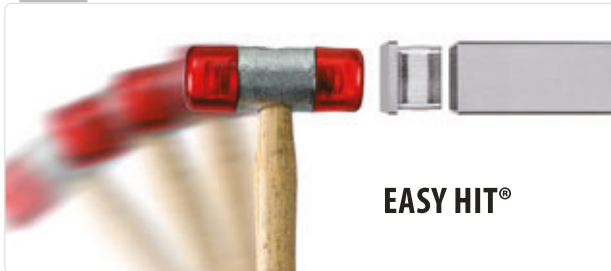

EASY HIT®

Q-INFO

MOD 4811 / 4733

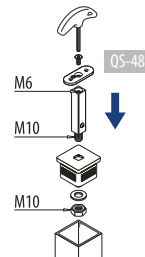

Q-INFO

MOD 4727



Q-21

Q-glye

50 ml

19.1331.000.00

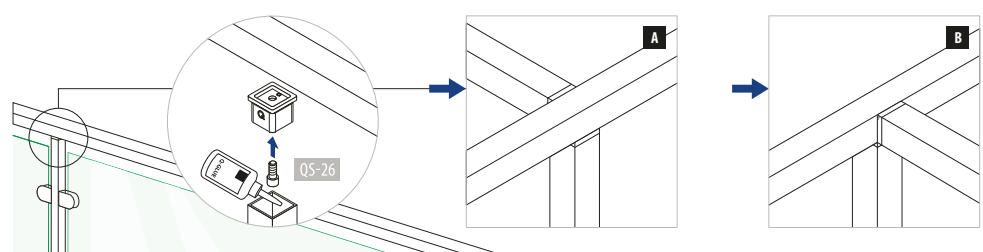

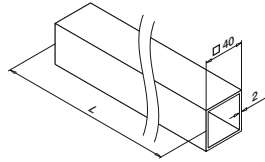

MOD 4925 / 4900

304

INDOOR	□	☐
13.4925.040.12	40 x 40 x 2,0	L = 2500 mm
13.4900.040.12	40 x 40 x 2,0	L = 5000 mm

316

OUTDOOR	□	☐
14.4925.040.12	40 x 40 x 2,0	L = 2500 mm
14.4900.040.12	40 x 40 x 2,0	L = 5000 mm

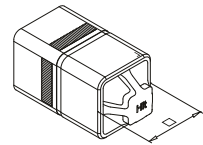
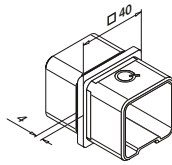

MOD 4790

304

INDOOR	□	☐
13.4790.040.12	40 x 40	2

316

OUTDOOR	□	☐
14.4790.040.12	40 x 40	2



MOD 5792 - EASY HIT®

316

Raw

OUTDOOR	□	☐
14.5792.040.00	for 40 x 40	2



International Design Model Protection

Q-INFO

MOD 5792

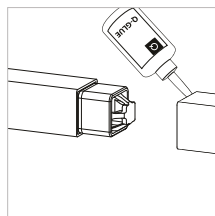
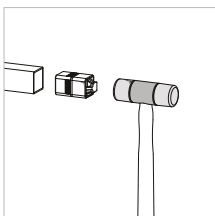

Q-21
Q-glue
50 ml
19.1331.000.00

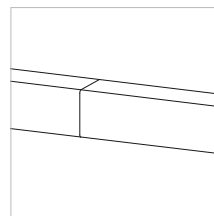

Q-INFO

MOD 4925 / 4900

Calculation basis for tubes

calculated by **ONDRA**

	□(mm)	A (cm ²)	I _x =I _y (cm ⁴)	W _x =W _y (cm ³)	M (kg/m)	R _{p0,2} (kN/cm ²)	R _m (kN/cm ²)
13.4900.040.12 / 13.4925.040.12	40 x 40	3,04	7,30	1,83	2,38	23	54
14.4900.040.12 / 14.4925.040.12	40 x 40	3,04	7,30	1,83	2,38	24	53

A = cross sectional area
I_x / I_y = second moment of area
W_x / W_y = section modulus
M = weight
R_{p0,2} = permissible stress
R_m = minimum tensile strength

SQUARE LINE® 40x40 - Connectors

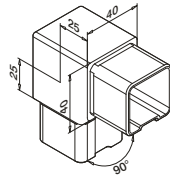

MOD 4301

304

INDOOR



13.4301.040.12

40 x 40

2

316

OUTDOOR



14.4301.040.12

40 x 40

2

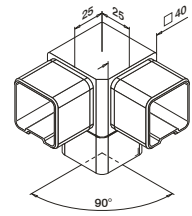

MOD 4304

304

INDOOR



13.4304.040.12

40 x 40

2

316

OUTDOOR



14.4304.040.12

40 x 40

2



SQUARE LINE® 40x40 - Connectors, adjustable



0-70°

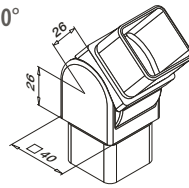

MOD 4312

304

INDOOR



13.4312.040.12

40 x 40

2

316

OUTDOOR



14.4312.040.12

40 x 40

2



0-70°

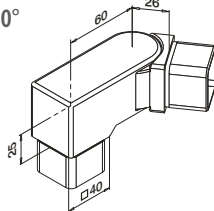

MOD 4317

304

INDOOR



13.4317.040.12

40 x 40

2



0-70°

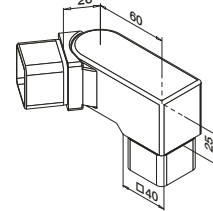

MOD 4318

304

INDOOR



13.4318.040.12

40 x 40

2



Q-INFO

MOD 4317



Q-21

Q-glue

50 ml

19.1331.000.00

90°

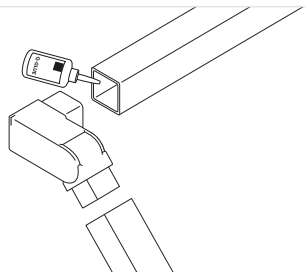

Q-INFO

MOD 4318



Q-21

Q-glue

50 ml

19.1331.000.00

90°

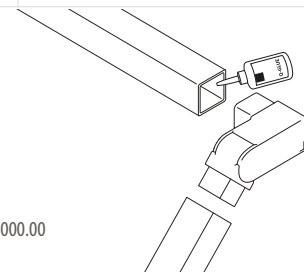

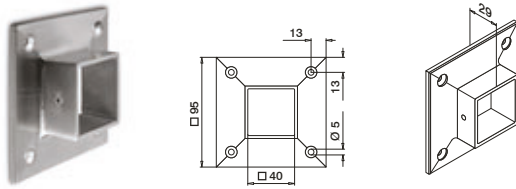
**MOD 4505****304****INDOOR**

13.4505.040.12	QS-5 302	2
----------------	-----------	---

316**OUTDOOR**

14.4505.040.12	QS-6 302	2
----------------	-----------	---

**MOD 4732****304****INDOOR**

13.4732.040.12		2
----------------	--	---

316**OUTDOOR**

14.4732.040.12		2
----------------	--	---

**MOD 5728 - EASY HIT®****316****OUTDOOR**

14.5728.040.12		2
----------------	--	---



Q-INFO

MOD 5728

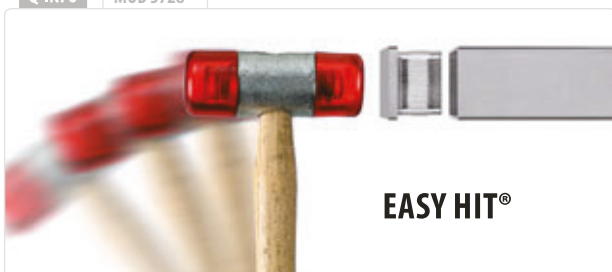

Q-INFO



Q-23
Q-cleaner
300 ml
19.0601.000.00

Q-INFO



Q-22
Q-ultra-clean
500 ml
19.0610.000.00



SQUARE LINE® 40x10

Seamless and edgy, with no visible screws to distract the eye, these unique square handrails are a design exclusive. The Square Line® handrail system proves how simple good design can be. Matching connectors and end pieces make it possible for you to finish this wall handrail to the last detail.

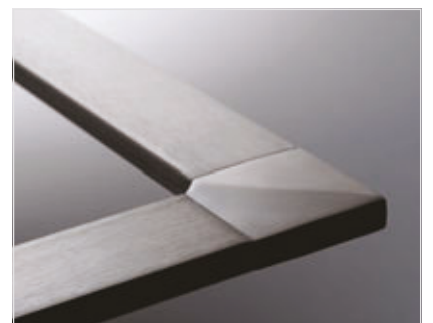



Wall - tube

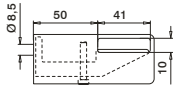
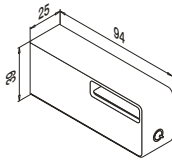

MOD 4134 - □ 40 x 10 mm

304

INDOOR



13.4134.041.12 40 x 10 x 1,5 QS-35 □ 310 / QS-3 □ 302 2

316

OUTDOOR



14.4134.041.12 40 x 10 x 1,5 QS-34 □ 310 / QS-4 □ 302 2



International Design Model Protection

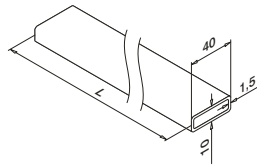

MOD 4925 / 4900 - □ 40 x 10 mm

304

INDOOR



13.4925.041.12 40 x 10 x 1,5 L = 2500 mm

13.4900.041.12 40 x 10 x 1,5 L = 5000 mm

316

OUTDOOR



14.4925.041.12 40 x 10 x 1,5 L = 2500 mm

14.4900.041.12 40 x 10 x 1,5 L = 5000 mm



Q-INFO

MOD 4134 / 4900 / 4925

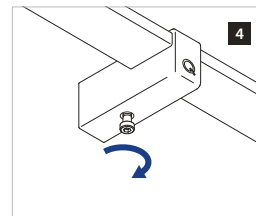
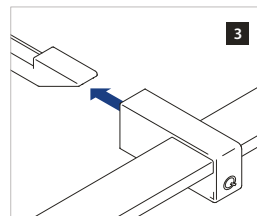
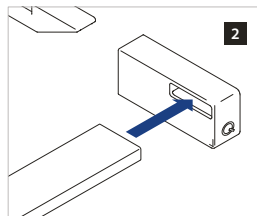
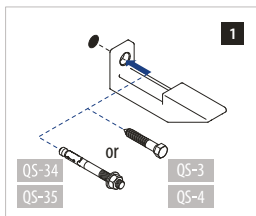

Q-INFO

MOD 4925 / 4900

Calculation basis for tubes

calculated by ONDRA

	□ (mm)	A (cm ²)	I _x (cm ⁴)	I _y (cm ⁴)	W _x (cm ³)	W _y (cm ³)	M (kg/m)	R _{p0,2} (kN/cm ²)	R _m (kN/cm ²)
13.4900.041.12 / 13.4925.041.12	40 x 10	1,38	0,22	2,28	0,44	1,14	2,4	23	54
14.4900.041.12 / 14.4925.041.12	40 x 10	1,38	0,22	2,28	0,44	1,14	2,4	24	53

A = cross sectional area
 I_x / I_y = second moment of area
 W_x / W_y = section modulus
 M = weight
 R_{p0,2} = permissible stress
 R_m = minimum tensile strength

SQUARE LINE® 40x10 - Connectors

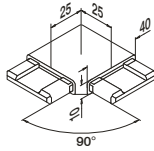
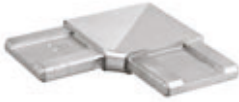

MOD 4301

304		
INDOOR	<input type="checkbox"/>	
13.4301.041.12	40 x 10 x 1,5	2
316		
OUTDOOR	<input type="checkbox"/>	
14.4301.041.12	40 x 10 x 1,5	2

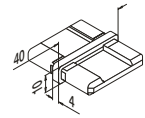

MOD 4790

304		
INDOOR	<input type="checkbox"/>	
13.4790.041.12	40 x 10 x 1,5	2
316		
OUTDOOR	<input type="checkbox"/>	
14.4790.041.12	40 x 10 x 1,5	2



SQUARE LINE® 40x10 - End fittings

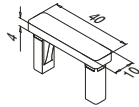

MOD 4732

304		
INDOOR	<input type="checkbox"/>	
13.4732.041.12	40 x 10 x 1,5	2
316		
OUTDOOR	<input type="checkbox"/>	
14.4732.041.12	40 x 10 x 1,5	2



Q-INFO



Q-23
Q-cleaner
300 ml
19.0601.000.00

Q-INFO



Q-22
Q-ultra-clean
500 ml
19.0610.000.00



SQUARE LINE® 60x30

This is the robust version of Square Line®. With a depth of 60 mm, its balusters have just that bit more body and can therefore withstand even more loads. Furthermore, the look of Square Line 60x30 offers something fresh and new within the Square range. For infill you can use vertical bars, glass with glass clamps or our Spider glass adapters.



GOEDKEURING
VOLGENS BB2012
EUROCODES
1990-1999:2011
NEN2608

**STATISCHE
BERECHNUNG**
GEMÄß TRAV



Posts

SATIN

SQUARE LINE® 60x30 - Baluster posts



Top mount

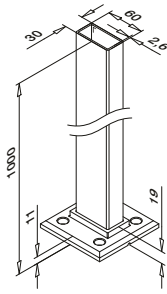
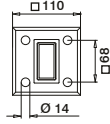
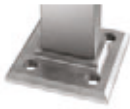

MOD 4901

316

OUTDOOR

14.4901.063.12

60 x 30 x 2,6

Q5-559 308

1



Infloor
Fascia mount

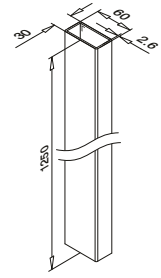

MOD 4902

316

OUTDOOR

14.4902.063.12

60 x 30 x 2,6

1



Posts

SATIN

SQUARE LINE® 60x30 - Flanges for balusters

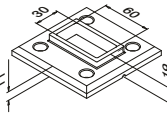
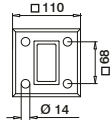
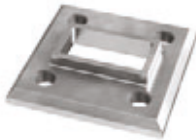

MOD 3503

316

OUTDOOR

14.3503.063.00

110

Q5-559 308

2



Posts

SATIN

SQUARE LINE® 60x30 - End caps

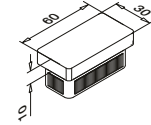

MOD 5728 - EASY HIT®

316

OUTDOOR

14.5728.063.12

60 x 30 x 2,6

2



International Design Model Protection

Posts

SATIN

SQUARE LINE® 60x30 - Tubes

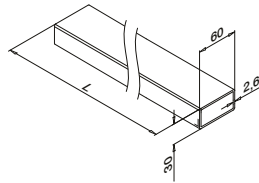

MOD 4900

316

OUTDOOR

14.4900.063.12

60 x 30 x 2,6

L = 5000 mm



Q-TUBE

Q-INFO



Q-23
Q-cleaner
300 ml
19.0601.000.00

Q-INFO



Q-22
Q-ultra-clean
500 ml
19.0610.000.00

Q-INFO

MOD 4901

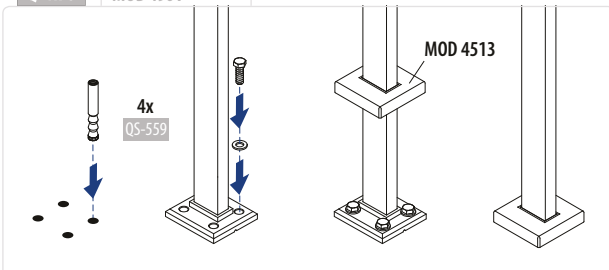

Q-INFO

MOD 5728

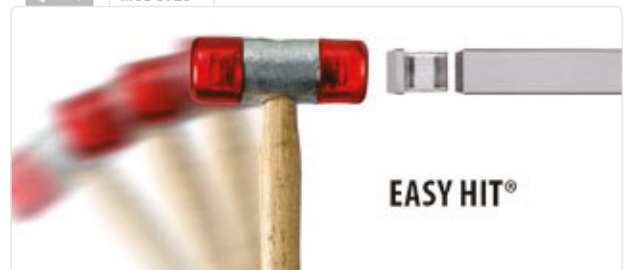

EASY HIT®

SQUARE LINE® 60x30 - Cover caps

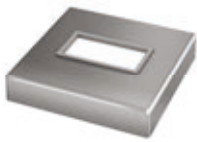

Top mount

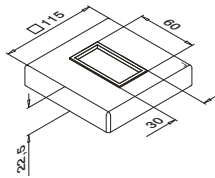

MOD 4513

316

OUTDOOR

14.4513.063.12



2

NEW

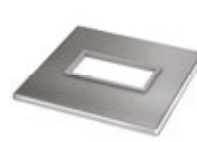

Infloor

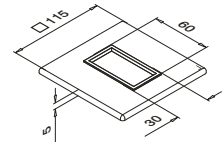

MOD 4512

316

OUTDOOR

14.4512.063.12



2

NEW

SQUARE LINE® 60x30 - Baluster brackets

Fascia mount

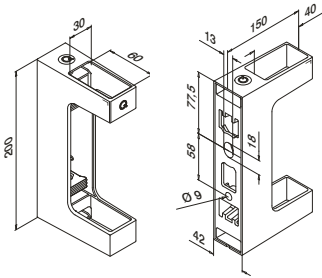

MOD 4558

316

OUTDOOR

14.4558.063.12

60 x 30



QS-559 308



1

NEW



International Design Model Protection



Q-INFO

MOD 4558

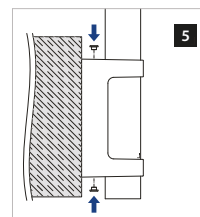
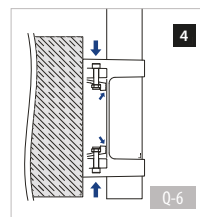
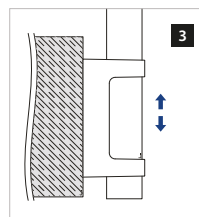
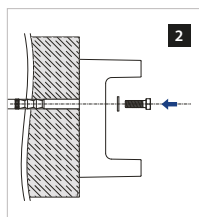
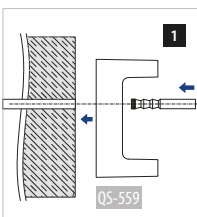

Q-INFO

MOD 4901

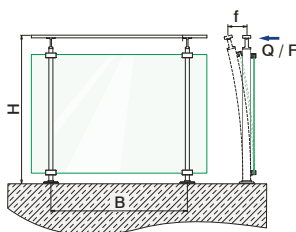

Square Line® 60x30 (Static calculation)

MOD	Country	Square Line® 60x30 (Static calculation)		Indoor		Outdoor		
		Q	F	B (max)	B (max)	wind	H (max)	f
4901.063	Germany	0,50 kN/m	-	1500 mm	1300 mm	0,70* kN/m ²	1100 mm	< 25 mm
	France	0,50 kN/m	1,00 kN/1 min.	1200 mm	1200 mm	1,79 kN/m ²	1000 mm	< 20 mm
	Germany	1,00 kN/m	-	1000 mm	900 mm	0,70* kN/m ²	1100 mm	< 25 mm
	France	0,80 kN/m	1,00 kN/5 min.	1200 mm	1200 mm	1,79 kN/m ²	1000 mm	< 20 mm

* Line load and wind force combined

Q-INFO

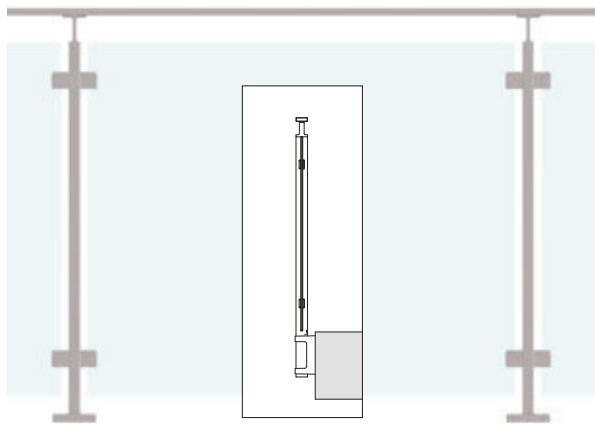

262 Glass clamps - MOD 21

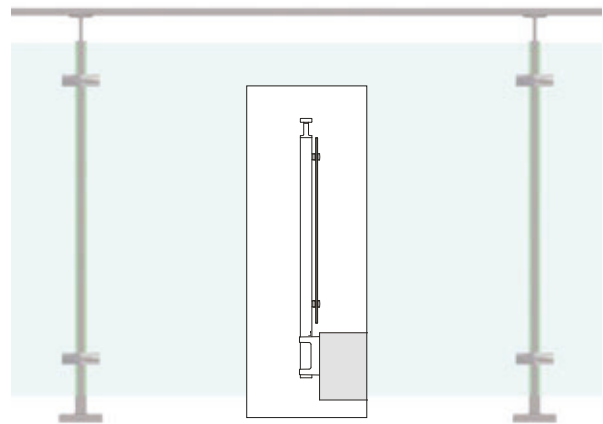

96 Glass clamps - MOD 29

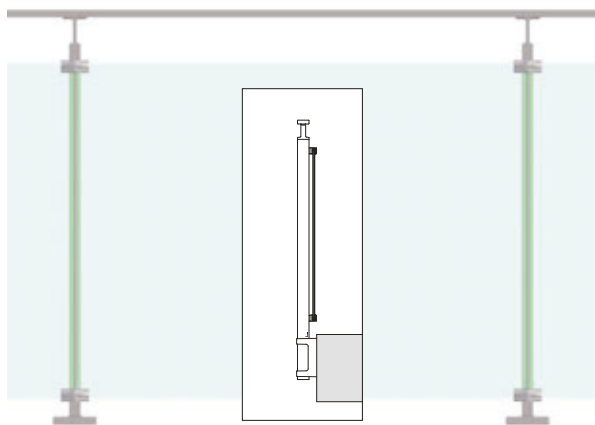

95 Glass holders - MOD 55

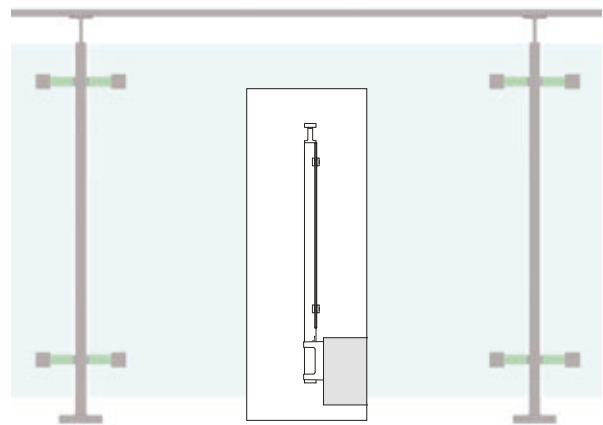

290 Glass adapters - Spider MOD 4752

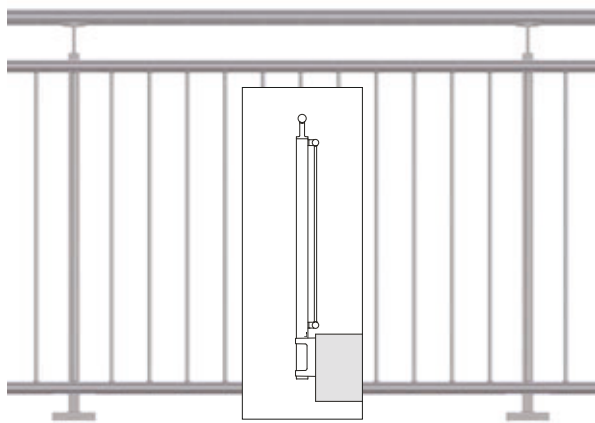

98, 100 Picket rail / vertical bar filling

Combine Square Line 60x30 with our other well known infills and products.

SQUARE LINE® 60x30 - Handrail brackets

Tube - flat

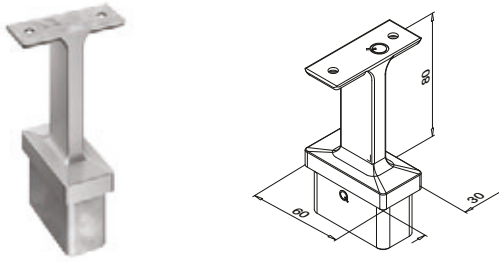

MOD 4711 - □ 60 x 30 x 2,6 mm

316

OUTDOOR

14.4711.000.12



QS-13 303



2

NEW



International Design Model Protection

Tube - tube

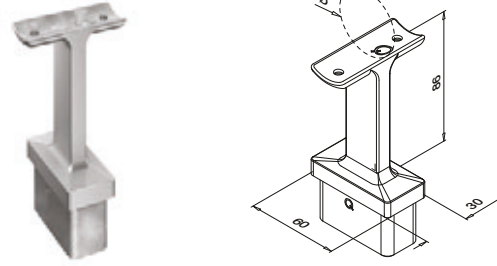

MOD 4711 - □ 60 x 30 x 2,6 mm

316

OUTDOOR

14.4711.042.12



42,4



QS-13 303



2

NEW



International Design Model Protection

SQUARE LINE® 60x30 - Handrail adapters

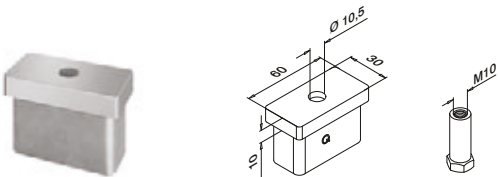

MOD 4725 - □ 60 x 30 x 2,6 mm

316

OUTDOOR

14.4725.063.12



2

NEW



SQUARE LINE® 60x30 - Tubes

Q-TUBE

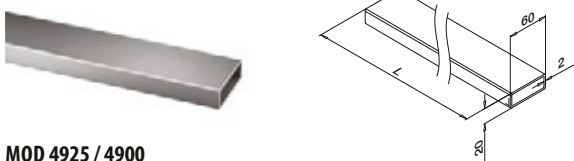

MOD 4925 / 4900

316

OUTDOOR

14.4925.262.12



60 x 20 x 2,0



L = 2500 mm

14.4900.262.12

60 x 20 x 2,0

L = 5000 mm

NEW



L=5000mm

Q-INFO

MOD 4711

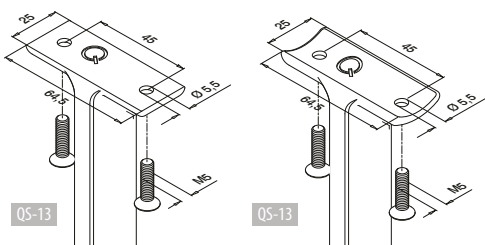

Q-INFO

MOD 4725

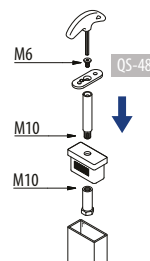

SQUARE LINE® 60x20 - Connectors



0 - 70°

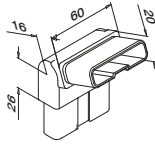

MOD 4312

316

OUTDOOR



14.4312.262.12 60 x 20 x 2,0

2

NEW



International Design Model Protection

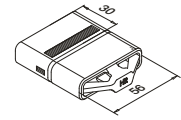
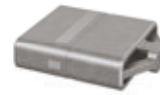

MOD 5792 - EASY HIT®

316

OUTDOOR



14.5792.262.00 for 60 x 20 x 2,0

2

NEW



International Design Model Protection

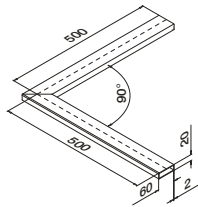

MOD 4320

316

OUTDOOR



14.4320.262.12 60 x 20 x 2,0

2

NEW

SQUARE LINE® 60x20 - End caps

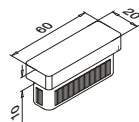

MOD 5727 - EASY HIT®

316

OUTDOOR



14.5727.262.12 60 x 20 x 2,0

2

NEW



International Design Model Protection

Q-INFO

MOD 5727

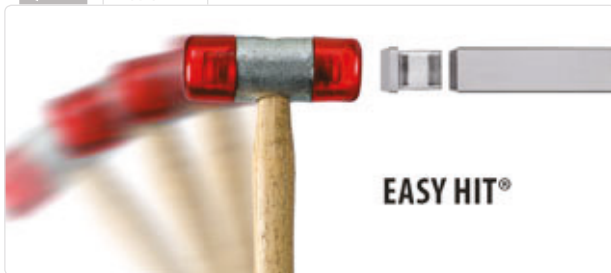

Q-INFO

MOD 5792

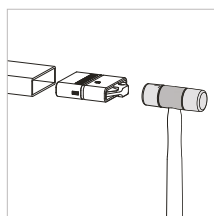

Q-21

Q-glue
50 ml

19.1331.000.00

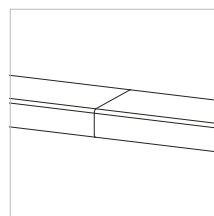
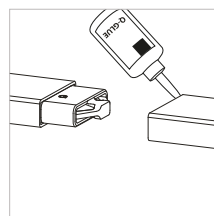

Q-INFO



Q-22

Q-ultra-clean
500 ml
19.0610.000.00



Q-LINE

The baluster railing system based on round shapes, our classic Q-line provides unlimited design possibilities. From the transparency and efficiency of glass-filled railings, to the endless lines of bar infills or the industrial look of cable systems or web infills, Q-line's minimalist design is timeless.



**STATISCHE
BERECHNUNG
GEMÄß TRAV**

**APPROVED
to BS 6180**







4 mm inner tube!

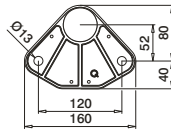
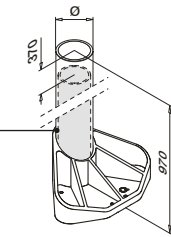

MOD 0561

304

INDOOR	Ø		
13.0561.248.12	48,3 x 2,0	Q5-33 306	1



TESTED Q-INFO

EXTRA STRONG

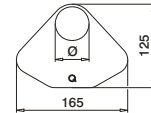

MOD 0518

304

INDOOR	Ø	
13.0518.048.12	48,3	2



MOD 0715, 0716

185

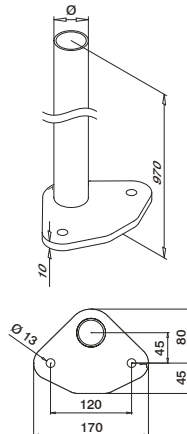

MOD 0542

304

INDOOR	Ø		
13.0542.042.12	42,4 x 2,6	Q5-33 306	1

316

OUTDOOR	Ø		
14.0542.042.12	42,4 x 2,6	Q5-32 306	1



If you have a specific requirement for pre-assembled products please use our order forms on pages 324 - 336.

Q-INFO

MOD 0561

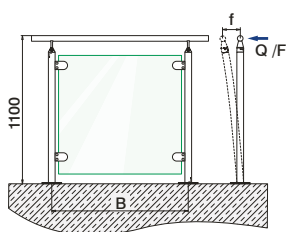

Q-line (Tested)

		Q / F	B (max)	f
MOD 0561		0,50 kN/m	1500 mm	≤ 25 mm
		0,74 kN/m	1500 mm	≤ 25 mm
		1,00 kN/m	1100 mm	≤ 25 mm
		1,50 kN/m	1100 mm	≤ 25 mm

British Standard BS 6399 BS 6399-1 : 1996 (incorp. amendm. No. 1)

Q-INFO

MOD 0542

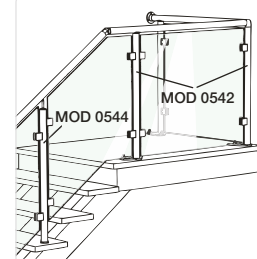

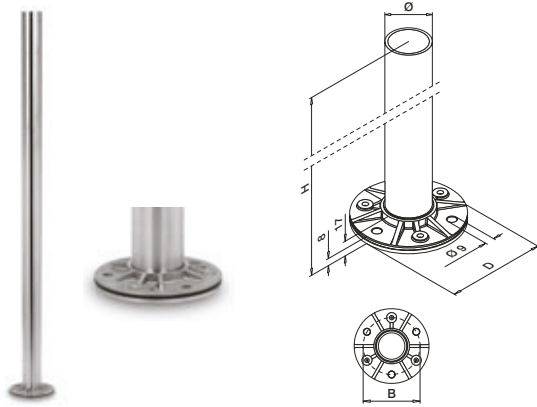
**MOD 0912****304**

INDOOR	Ø	B	D	H		
13.0912.242.12	42,4 x 2,0	80	Ø 105	989	QS-35	310 1

316

OUTDOOR	Ø	B	D	H		
14.0912.242.12	42,4 x 2,0	80	Ø 105	989	QS-34	310 1
14.0912.042.12	42,4 x 2,6	80	Ø 105	989	QS-34	310 1

MOD 0913**304**

INDOOR	Ø	B	D	H		
13.0913.242.12	42,4 x 2,0	80	Ø 105	970	QS-35	310 1
13.0913.248.12	48,3 x 2,0	90	Ø 115	970	QS-35	310 1
13.0913.042.12	42,4 x 2,6	80	Ø 105	970	QS-35	310 1
13.0913.048.12	48,3 x 2,6	90	Ø 115	970	QS-35	310 1

316

OUTDOOR	Ø	B	D	H		
14.0913.042.12	42,4 x 2,6	80	Ø 105	970	QS-34	310 1
14.0913.048.12	48,3 x 2,6	90	Ø 115	970	QS-34	310 1

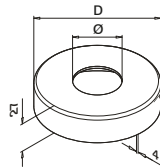
**MOD 0511****304**

INDOOR	Ø	D	
13.0511.042.12	42,4	Ø 110	2
13.0511.048.12	48,3	Ø 120	2

316

OUTDOOR	Ø	D	
14.0511.042.12	42,4	Ø 110	2
14.0511.048.12	48,3	Ø 120	2

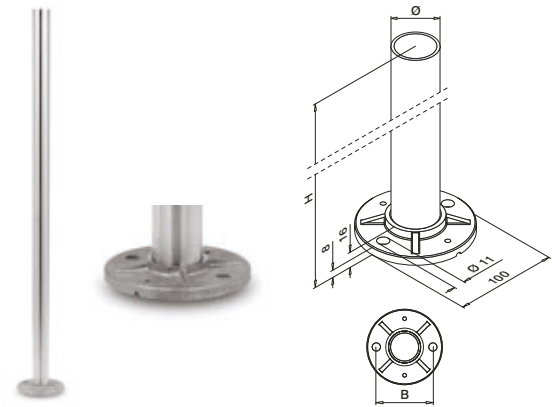
**MOD 0914****304**

INDOOR	Ø	H	B		
13.0914.242.12	42,4 x 2,0	970	75	QS-59	310 1
13.0914.248.12	48,3 x 2,0	970	80	QS-59	310 1 Tested
13.0914.042.12	42,4 x 2,6	970	75	QS-59	310 1
13.0914.048.12	48,3 x 2,6	970	80	QS-59	310 1

316

OUTDOOR	Ø	H	B		
14.0914.242.12	42,4 x 2,0	970	75	QS-58	310 1
14.0914.248.12	48,3 x 2,0	970	80	QS-58	310 1 Tested
14.0914.042.12	42,4 x 2,6	970	75	QS-58	310 1
14.0914.048.12	48,3 x 2,6	970	80	QS-58	310 1

MOD 0944**304**

INDOOR	Ø	H	B		
13.0944.242.12	42,4 x 2,0	1150	75	QS-59	310 1
13.0944.248.12	48,3 x 2,0	1150	80	QS-59	310 1

316

OUTDOOR	Ø	H	B		
14.0944.242.12	42,4 x 2,0	1150	75	QS-58	310 1
14.0944.248.12	48,3 x 2,0	1150	80	QS-58	310 1

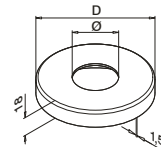
TESTED
80**MOD 0512****304**

INDOOR	Ø	D	
13.0512.042.12	42,4	Ø 105	2
13.0512.048.12	48,3	Ø 105	2

316

OUTDOOR	Ø	D	
14.0512.042.12	42,4	Ø 105	2
14.0512.048.12	48,3	Ø 105	2

Q-INFO**MOD 0511**

Rubber ring



If you have a specific requirement for pre-assembled products please use our order forms on pages 324 - 336.

Q-LINE - Standard baluster posts with threaded holes

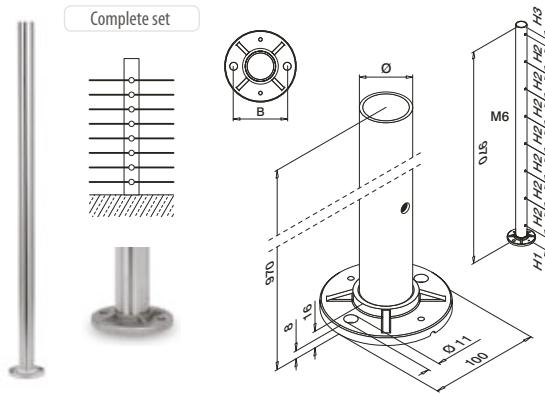

MOD 0930

304

INDOOR	Ø	B	H1	H2	H3		
13.0930.242.12	42,4 x 2,0	75	60	125	35	QS-59	310 1

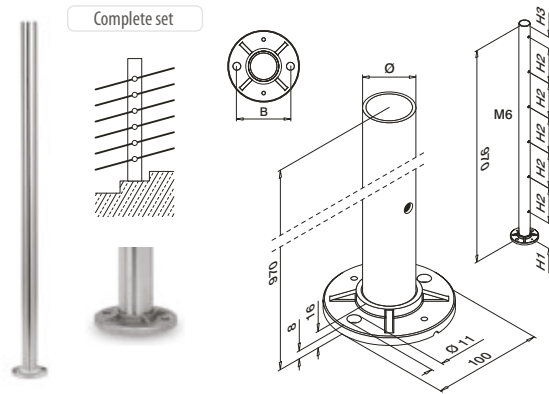

MOD 0931

304

INDOOR	Ø	B	H1	H2	H3		
13.0931.242.12	42,4 x 2,0	75	125	160	45	QS-59	310 1

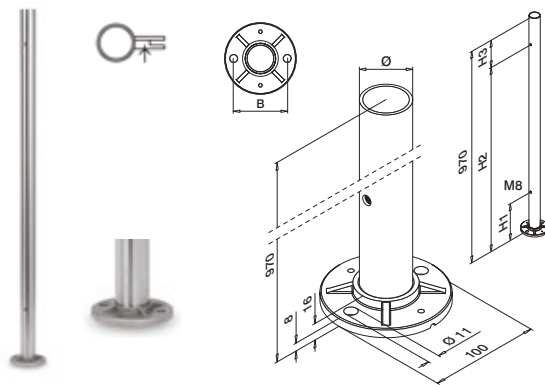

MOD 0932

304

INDOOR	Ø	B	H1	H2	H3		
13.0932.242.12	42,4 x 2,0	75	175	850	120	QS-59	310 1
13.0932.248.12	48,3 x 2,0	80	175	850	120	QS-59	310 1

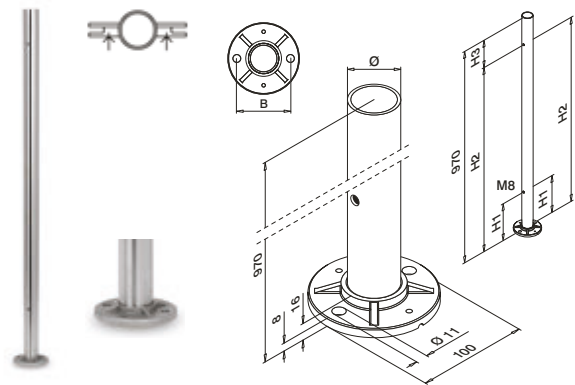

MOD 0933

304

INDOOR	Ø	B	H1	H2	H3		
13.0933.242.12	42,4 x 2,0	75	175	850	120	QS-59	310 1
13.0933.248.12	48,3 x 2,0	80	175	850	120	QS-59	310 1

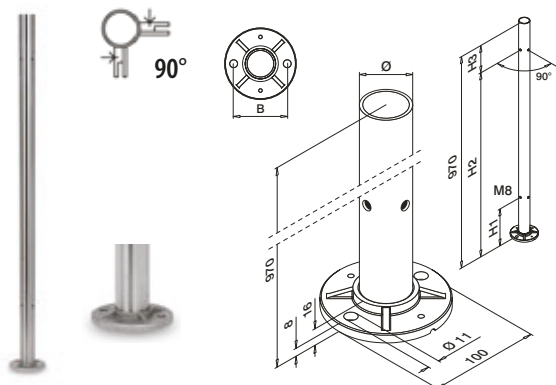

MOD 0934

304

INDOOR	Ø	B	H1	H2	H3		
13.0934.242.12	42,4 x 2,0	75	175	850	120	QS-59	310 1
13.0934.248.12	48,3 x 2,0	80	175	850	120	QS-59	310 1



MOD 0512

304

INDOOR	Ø	D	
13.0512.042.12	42,4	Ø 105	2
13.0512.048.12	48,3	Ø 105	2

Q-INFO

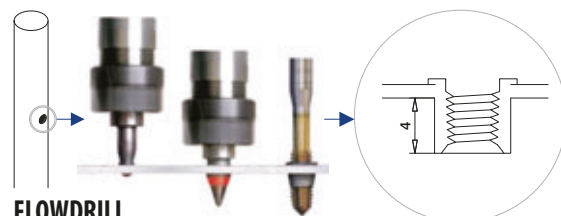

FLOWDRILL

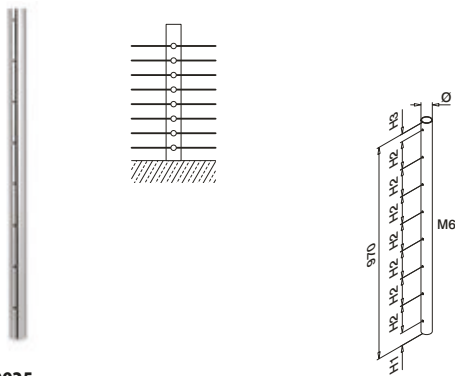

MOD 0925

304						
INDOOR	Ø	H1	H2	H3		
13.0925.242.12	42,4 x 2,0	57	125	35	1	

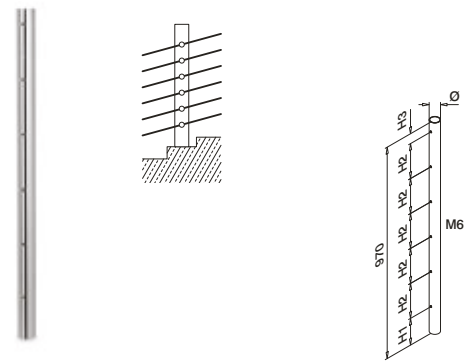

MOD 0926

304						
INDOOR	Ø	H1	H2	H3		
13.0926.242.12	42,4 x 2,0	122	160	45	1	

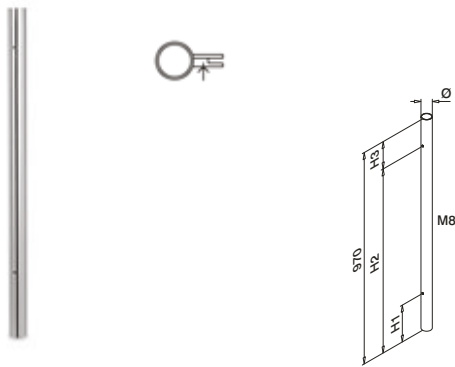

MOD 0927

304						
INDOOR	Ø	H1	H2	H3		
13.0927.242.12	42,4 x 2,0	170	850	120	1	

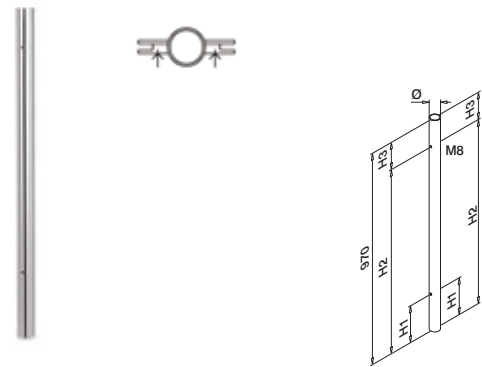

MOD 0928

304						
INDOOR	Ø	H1	H2	H3		
13.0928.242.12	42,4 x 2,0	170	850	120	1	

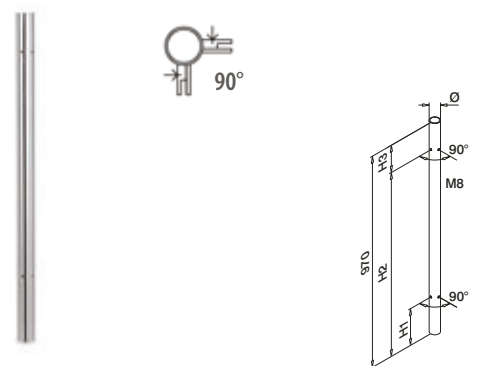
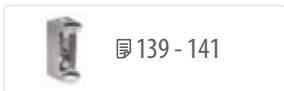
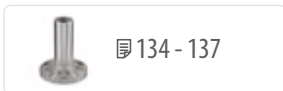

MOD 0929

304						
INDOOR	Ø	H1	H2	H3		
13.0929.242.12	42,4 x 2,0	170	850	120	1	



Q-INFO

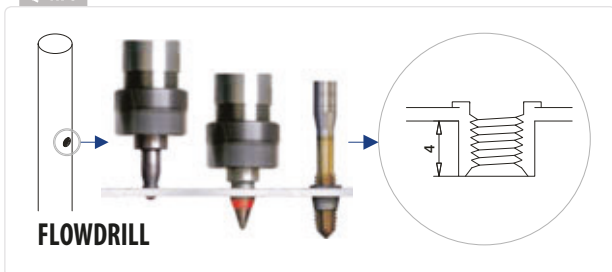

FLOWDRILL

Q-LINE - Standard baluster post tubes with threaded holes - 1250 mm

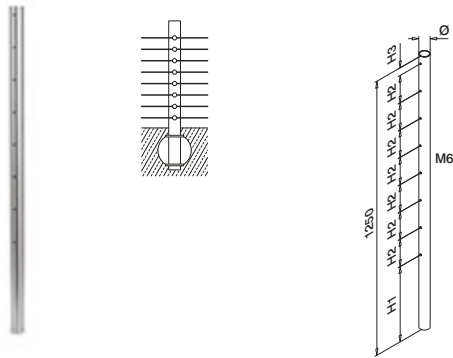

MOD 0935

304

INDOOR	Ø	H1	H2	H3	
13.0935.242.12	42,4 x 2,0	340	125	35	1

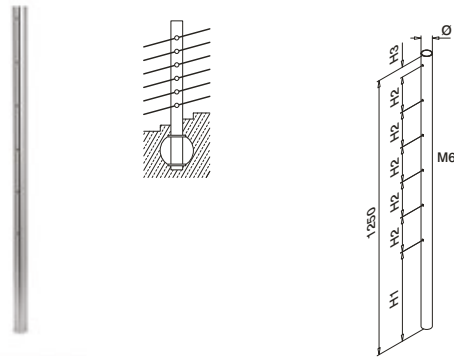

MOD 0936

304

INDOOR	Ø	H1	H2	H3	
13.0936.242.12	42,4 x 2,0	405	160	45	1

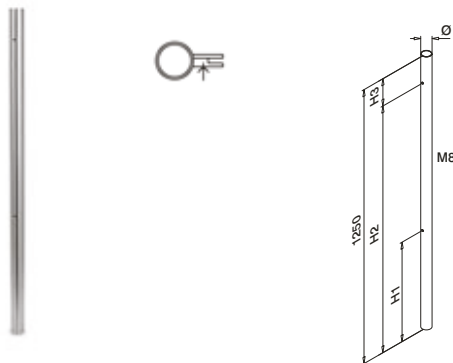

MOD 0937

304

INDOOR	Ø	H1	H2	H3	
13.0937.242.12	42,4 x 2,0	455	1130	120	1

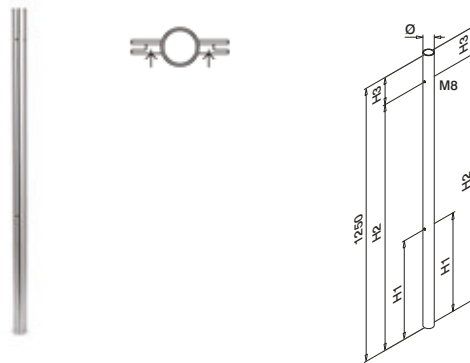

MOD 0938

304

INDOOR	Ø	H1	H2	H3	
13.0938.242.12	42,4 x 2,0	455	1130	120	1

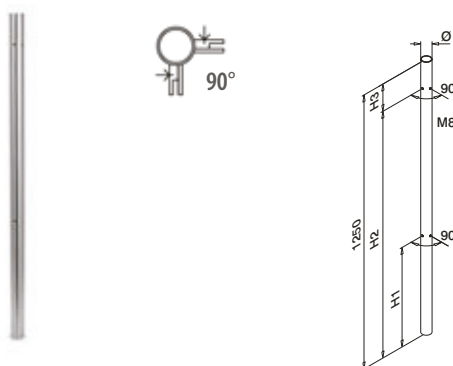

MOD 0939

304

INDOOR	Ø	H1	H2	H3	
13.0939.242.12	42,4 x 2,0	455	1130	120	1



Q-INFO

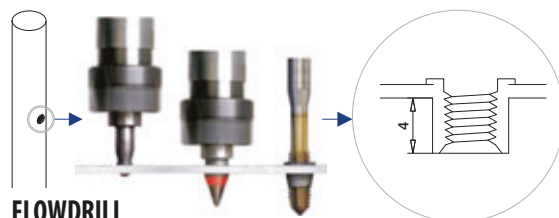

FLOWDRILL

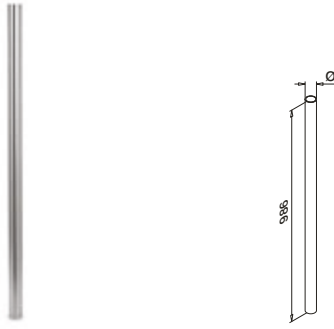

MOD 0901

304

INDOOR	∅	
13.0901.242.12	42,4 x 2,0	1
13.0901.248.12	48,3 x 2,0	1



134 - 137



139 - 141

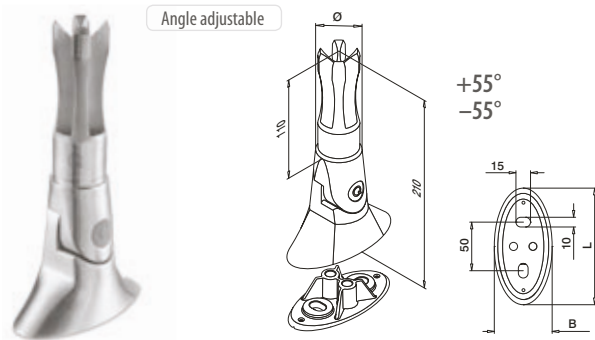

MOD 0945

304

INDOOR	∅	B	L		
13.0945.242.12	42,4 x 2,0	59	118	QS-65	306 1
13.0945.248.12	48,3 x 2,0	65	118	QS-65	306 1

316

OUTDOOR	∅	B	L		
14.0945.242.12	42,4 x 2,0	59	118	QS-64	306 1

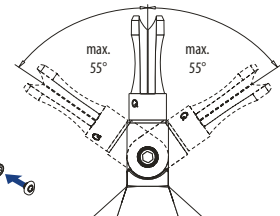
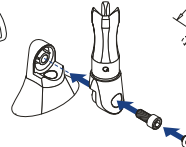
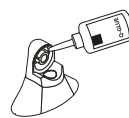
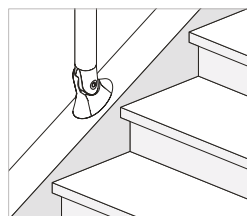
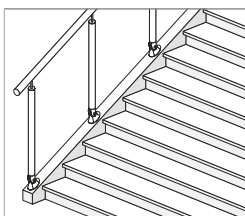

Q-LINE - Base flanges for glue connection

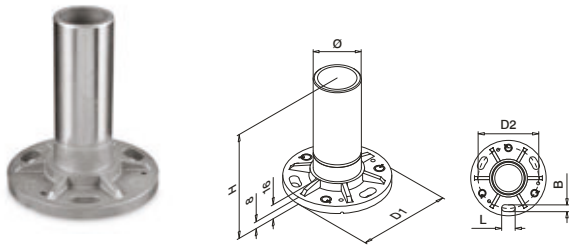

MOD 0942

304

INDOOR	Ø	H	D1	D2	B x L	⚙️	📦
13.0942.233.00	33,7 x 2,0	126	100	80	9x28	QS-35	310 2
13.0942.242.00	42,4 x 2,0	126	100	80	9x18	QS-35	310 2
13.0942.248.00	48,3 x 2,0	126	100	80	9x18	QS-35	310 2
13.0942.060.00	60,3 x 2,0	126	120	90	11x30	QS-59	310 2

316

OUTDOOR	Ø	H	D1	D2	B x L	⚙️	📦
14.0942.233.00	33,7 x 2,0	126	100	80	9x28	QS-34	310 2
14.0942.242.00	42,4 x 2,0	126	100	80	9x18	QS-34	310 2
14.0942.248.00	48,3 x 2,0	126	100	80	9x18	QS-34	310 2
14.0942.060.00	60,3 x 2,0	126	120	90	11x30	QS-58	310 2



No cover cap necessary

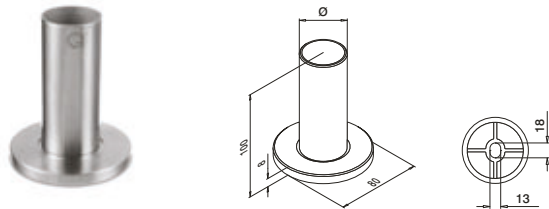

MOD 0946

304

INDOOR	Ø	⚙️	📦
13.0946.242.12	42,4 x 2,0	QS-33	306 2
13.0946.248.12	48,3 x 2,0	QS-33	306 2



Q-INFO MOD 0942

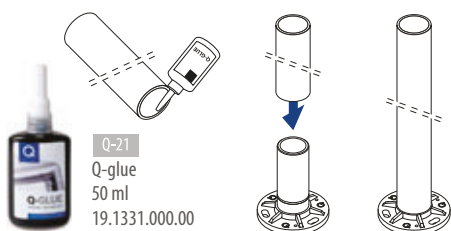

Q-INFO MOD 0946



MOD 0512

304

INDOOR	Ø	D	📦
13.0512.033.12	33,7	Ø 105	2
13.0512.042.12	42,4	Ø 105	2
13.0512.048.12	48,3	Ø 105	2

316

OUTDOOR	Ø	D	📦
14.0512.033.12	33,7	Ø 105	2
14.0512.042.12	42,4	Ø 105	2
14.0512.048.12	48,3	Ø 105	2

MOD 0513

304

INDOOR	Ø	D	📦
13.0513.042.12	42,4	Ø 125	2
13.0513.048.12	48,3	Ø 125	2
13.0513.060.12	60,3	Ø 125	2

316

OUTDOOR	Ø	D	📦
14.0513.042.12	42,4	Ø 125	2
14.0513.048.12	48,3	Ø 125	2
14.0513.060.12	60,3	Ø 125	2



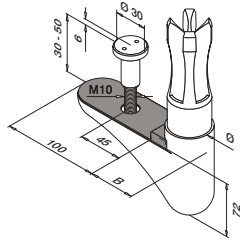

MOD 0947

304			
INDOOR	Ø	B	
13.0947.242.12	42,4 x 2,0	48	1



International Design Model Protection



Q-INFO

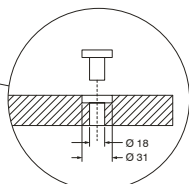
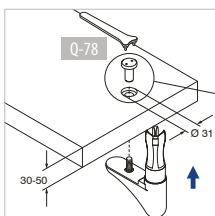

Q-21
Q-glu
50 ml
19.1331.000.00

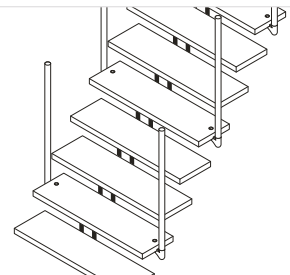
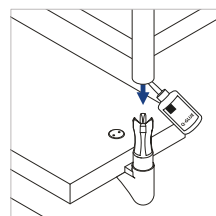



Complete set

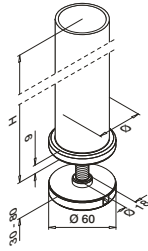

MOD 0544

304

INDOOR	Ø	H	Box
13.0544.042.12	42,4 x 2,6	970	1
13.0544.048.12	48,3 x 2,6	970	1

MOD 0564

304

INDOOR	Ø	H	Box
13.0564.242.12	42,4 x 2,0	1150	1

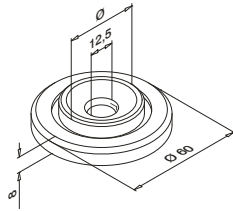

MOD 0501

304

INDOOR	Ø	Box
13.0501.042.12	42,4 x 2,0 + 42,4 x 2,6	2
13.0501.048.12	48,3 x 2,0 + 48,3 x 2,6	2

316

OUTDOOR	Ø	Box
14.0501.042.12	42,4 x 2,0 + 42,4 x 2,6	2

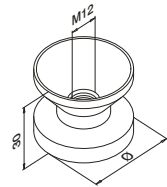

MOD 3501

304

INDOOR	Ø	Box
13.3501.242.00	42,4 x 2,0	2
13.3501.042.00	42,4 x 2,6	2

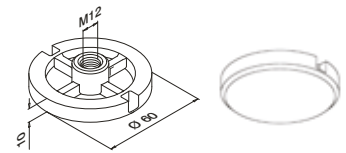

MOD 0731

304

INDOOR	Box
13.0731.060.12	2

316

OUTDOOR	Box
14.0731.060.12	2

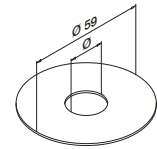

MOD 5080

Accessories

Accessories	Ø	Box
19.5080.060.00	18	20

MOD 5081

Accessories

Accessories	Ø	Box
19.5081.060.00	12	20

Q-INFO



Q-INFO

MOD 0544

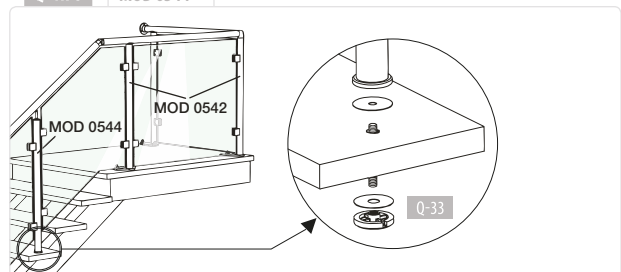



Q-LINE - Baluster brackets



Angle adjustable

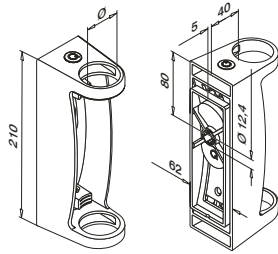

Angle NOT adjustable

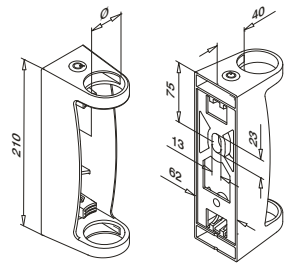

MOD 0556

304

INDOOR	Ø			
13.0556.042.12	42,4	QS-505	307 / QS-551	303 1
13.0556.048.12	48,3	QS-505	307 / QS-551	303 1



International Design Model Protection

MOD 0558

304

INDOOR	Ø			
13.0558.042.12	42,4	QS-33	306	1
13.0558.048.12	48,3	QS-33	306	1



International Design Model Protection



Angle NOT adjustable

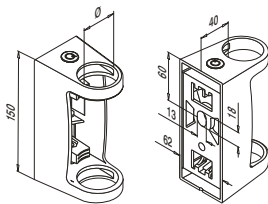

MOD 0557

304

INDOOR	Ø			
13.0557.042.12	42,4	QS-33	306	1
13.0557.048.12	48,3	QS-33	306	1

316

OUTDOOR	Ø			
14.0557.042.12	42,4	QS-32	306	1
14.0557.048.12	48,3	QS-32	306	1



International Design Model Protection



Spirit level

40, Ø 42,4, Ø 48,3 mm

MOD 0500

Accessories

	Q		
19.0500.000.00	Q-72		1

Q-INFO

MOD 0556

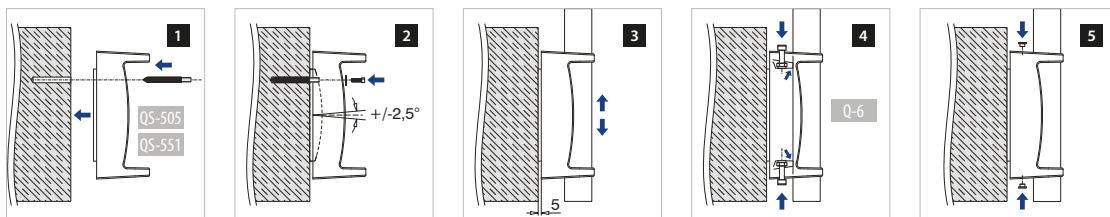

Q-INFO

MOD 0557 / 0558

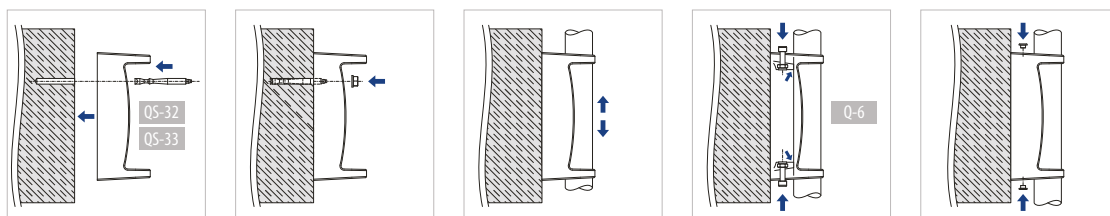

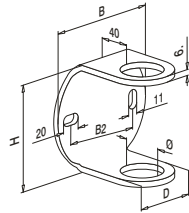

MOD 1550

304

INDOOR	Ø	H	B	B2	D		
13.1550.033.12	33,7	95	100	70	55	Q5-65	306 1
13.1550.042.12	42,4	110	120	85	65	Q5-65	306 1
13.1550.048.12	48,3	110	120	85	75	Q5-65	306 1



Spirit level

□ 40, Ø 42,4, Ø 48,3 mm

MOD 0500

Accessories

	Q	
19.0500.000.00	Q-72	1



MOD 0550

304

INDOOR	Ø	
13.0550.042.12	42,4	2
13.0550.048.12	48,3	2

316

OUTDOOR	Ø	
14.0550.042.12	42,4	2
14.0550.048.12	48,3	2



Q-INFO

MOD 0500



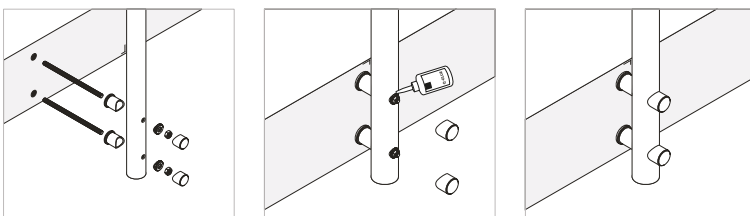

Q-INFO

MOD 0550

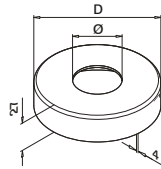





MOD 0511

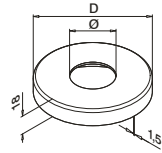

304			
INDOOR	Ø	D	
13.0511.042.12	42,4	Ø 110	2
13.0511.048.12	48,3	Ø 120	2
316			
OUTDOOR	Ø	D	
14.0511.042.12	42,4	Ø 110	2
14.0511.048.12	48,3	Ø 120	2



MOD 0512

304			
INDOOR	Ø	D	
13.0512.000.12	-	Ø 105	2
13.0512.033.12	33,7	Ø 105	2
13.0512.042.12	42,4	Ø 105	2
13.0512.048.12	48,3	Ø 105	2
13.0512.060.12	60,3	Ø 105	2
316			
OUTDOOR	Ø	D	
14.0512.033.12	33,7	Ø 105	2
14.0512.042.12	42,4	Ø 105	2
14.0512.048.12	48,3	Ø 105	2

MOD 0513

304			
INDOOR	Ø	D	
13.0513.042.12	42,4	Ø 125	2
13.0513.048.12	48,3	Ø 125	2
13.0513.060.12	60,3	Ø 125	2
316			
OUTDOOR	Ø	D	
14.0513.042.12	42,4	Ø 125	2
14.0513.048.12	48,3	Ø 125	2
14.0513.060.12	60,3	Ø 125	2

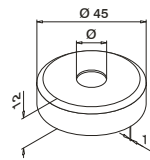

MOD 0514

304		
INDOOR	Ø	
13.0514.000.12	-	2
13.0514.012.12	12,0	2
13.0514.014.12	14,0	2

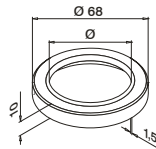

MOD 0517

316		
OUTDOOR	Ø	
14.0517.048.12	48,3	2

Q-INFO



Q-23
Q-cleaner
300 ml
19.0601.000.00

Q-INFO



Q-22
Q-ultra-clean
500 ml
19.0610.000.00

Q-LINE - Cover caps for baluster posts and flanges

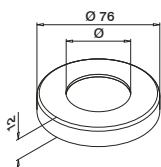

MOD 0515

304		
INDOOR	Ø	
13.0515.033.12	33,7	2
13.0515.040.12	40,0	2
13.0515.042.12	42,4	2

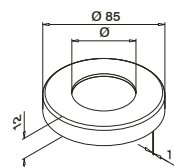

MOD 0516

304		
INDOOR	Ø	
13.0516.033.12	33,7	2
13.0516.042.12	42,4	2

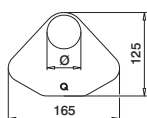

MOD 0518

304		
INDOOR	Ø	
13.0518.048.12	48,3	2

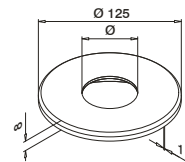

MOD 3572

304		
INDOOR	Ø	
13.3572.248.12	48,3	2

Q-LINE - Cover caps for handrail brackets

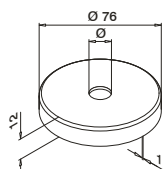

MOD 0515

304		
INDOOR	Ø	
13.0515.012.12	12,0	2
13.0515.014.12	14,0	2

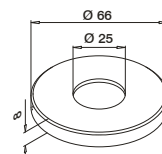
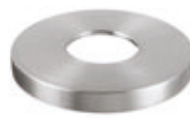

MOD 0520

304		
INDOOR		
13.0520.066.12		2
316		
OUTDOOR		
14.0520.066.12		2

NEW

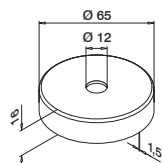

MOD 0519

Zinc	Stainless steel effect	
INDOOR		
10.0519.065.19		2

Q-INFO

MOD 0519

For MOD 0109, 0118 and 0113



Q-INFO

MOD 3572

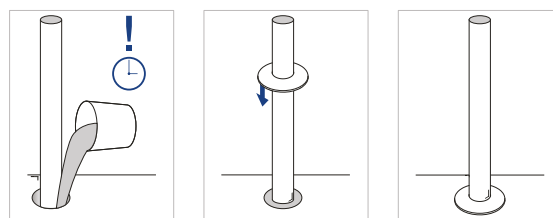



Q-LINE - Glass Frame Tube - Brackets

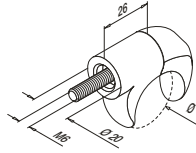

MOD 0860

304

INDOOR	Ø	
13.0860.000.12	30	2

316

OUTDOOR	Ø	
14.0860.000.12	30	2



International Design Model Protection

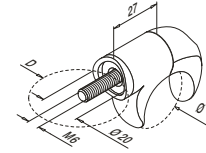

MOD 0860

304

INDOOR	D	Ø	
13.0860.042.12	42,4	30	2
13.0860.048.12	48,3	30	2

316

OUTDOOR	D	Ø	
14.0860.042.12	42,4	30	2
14.0860.048.12	48,3	30	2



International Design Model Protection

Q-LINE - Glass Frame Tube

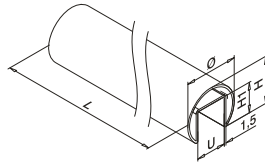

MOD 6920 / 6925 - Ø 30 mm

304

INDOOR	Ø	U	H	H1	
13.6925.030.12	30	14	27	18	L = 2500 mm
13.6920.030.12	30	14	27	18	L = 5000 mm

316

OUTDOOR	Ø	U	H	H1	
14.6925.030.12	30	14	27	18	L = 2500 mm
14.6920.030.12	30	14	27	18	L = 5000 mm



L=5000mm

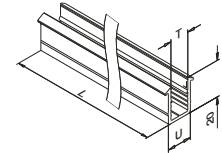

MOD 50 - Ø 30 mm

Accessories

	U	T	
19.5030.008.00	14	8 + 8,76	L = 5000 mm
19.5030.010.00	14	10 + 10,76	L = 5000 mm

Q-INFO

MOD 0860

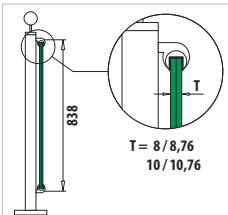

Q-INFO



Q-23
Q-cleaner
300 ml
19.0601.000.00

Q-INFO

MOD 6920 / 6925

Calculation basis for cap rails

calculated by ONDRA

	Ø (mm)	A (cm ²)	I _x (cm ⁴)	I _y (cm ⁴)	W _x (cm ³)	W _y (cm ³)	M (kg / m)	R _{p0,2} (kN / cm ²)	R _m (kN / cm ²)
13.692x.030.12	30	1,82	1,08	1,66	0,78	1,11	1,46	23	54
14.692x.030.12	30	1,82	1,08	1,66	0,78	1,11	1,46	24	53

A = cross sectional area
I_x / I_y = second moment of area
W_x / W_y = section modulus
M = weight
R_{p0,2} = permissible stress
R_m = minimum tensile strength

Q-INFO

MOD 0860

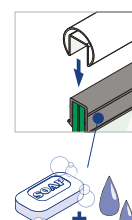
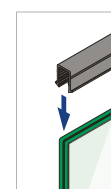
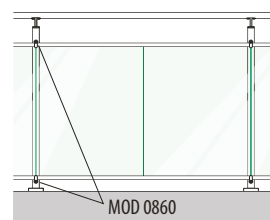

**MOD 6790**

304			
INDOOR	Ø		
13.6790.030.12	30 x 1,5		2
316			
OUTDOOR	Ø		
14.6790.030.12	30 x 1,5		2

**MOD 6313**

304			
INDOOR	Ø	H	
13.6313.030.12	30 x 1,5	25	2
316			
OUTDOOR	Ø	H	
14.6313.030.12	30 x 1,5	25	2

**MOD 6302**

304			
INDOOR	Ø	H	
13.6302.030.12	30 x 1,5	25	2
316			
OUTDOOR	Ø	H	
14.6302.030.12	30 x 1,5	25	2

**MOD 6312**

304			
INDOOR	Ø	H	
13.6312.030.12	30 x 1,5	25	2
316			
OUTDOOR	Ø	H	
14.6312.030.12	30 x 1,5	25	2

**MOD 6732**

304			
INDOOR	Ø		
13.6732.030.12	30 x 1,5		2
316			
OUTDOOR	Ø		
14.6732.030.12	30 x 1,5		2



Q-INFO



Q-21
Q-glu
50 ml
19.1331.000.00



Consumption per bonding ca. 1 ml

Q-Video www.q-railing.com

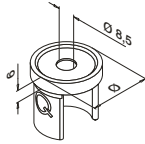

MOD 6728

304

INDOOR	Ø			
13.6728.000.12	30 x 1,5	QS-19	303	2

316

OUTDOOR	Ø			
14.6728.000.12	30 x 1,5	QS-20	303	2

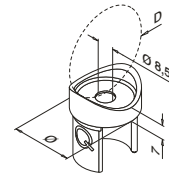

MOD 6728

304

INDOOR	Ø	D			
13.6728.042.12	30 x 1,5	42,4	QS-19	303	2

316

OUTDOOR	Ø	D			
14.6728.042.12	30 x 1,5	42,4	QS-20	303	2



Q-INFO

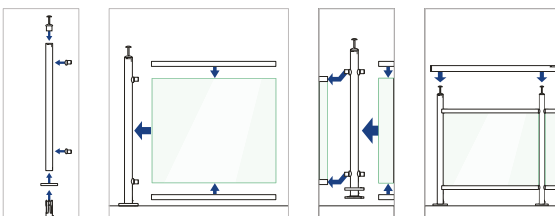

Q-INFO



Q-23
Q-cleaner
300 ml
19.0601.000.00

Q-INFO



Q-22
Q-ultra-clean
500 ml
19.0610.000.00

Q-LINE - Glass Frame Tube - Q-GLASS

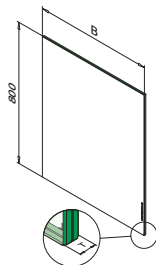

MOD 08 - VSG (ESG)* H=800 mm

Glass

OUTDOOR	B (mm)	T
50.0801.042.00	100	8,76 (4 - 0,76 - 4)
50.0802.042.00	200	8,76 (4 - 0,76 - 4)
50.0803.042.00	300	8,76 (4 - 0,76 - 4)
50.0804.042.00	400	8,76 (4 - 0,76 - 4)
50.0805.042.00	500	8,76 (4 - 0,76 - 4)
50.0806.042.00	600	8,76 (4 - 0,76 - 4)
50.0807.042.00	700	8,76 (4 - 0,76 - 4)
50.0808.042.00	800	8,76 (4 - 0,76 - 4)
50.0809.042.00	900	8,76 (4 - 0,76 - 4)
50.0809.542.00	950	8,76 (4 - 0,76 - 4)
50.0810.042.00	1000	8,76 (4 - 0,76 - 4)
50.0815.042.00	1500	8,76 (4 - 0,76 - 4)



VSG (2x ESG): Laminated glass from toughened glass

Q-INFO

Calculation

$$H (m) \times B (m) \times 2,5 \times T_g (mm) = kg$$

Example



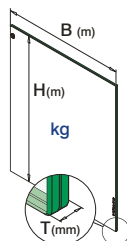

H	B	T
1,1 m	1,0 m	16 mm
$1,1 \times 1,0 \times 2,5 \times 16 = 44,00 \text{ kg}$		

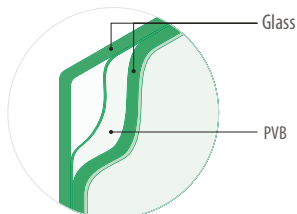
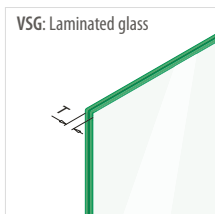

Q-INFO

VSG: Laminated glass



-  Smooth
-  Rounded edge
-  Polished
-  Rounded corners



TUBE AND BAR INFILLS

Create sleek, straight lines with tubes and bars in stainless steel 304 and 316 quality. Horizontal, vertical and even diagonal lines are all possible. Our assortment consists of tubes in 12, 14 and 16 mm diameters, and bars in 10, 12 and 14 mm diameters.

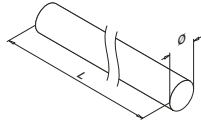

MOD 8925 / 0900

Ø 10 mm

304		
INDOOR	Ø	
13.8925.010.12	10	L = 2500 mm
13.0900.010.12	10	L = 5000 mm

Ø 12 mm

304		
INDOOR	Ø	
13.8925.012.12	12	L = 2500 mm
13.0900.012.12	12	L = 5000 mm



Ø 12 mm

316		
OUTDOOR	Ø	
14.8925.012.12	12	L = 2500 mm
14.0900.012.12	12	L = 5000 mm

Ø 14 mm

304		
INDOOR	Ø	
13.8925.014.12	14	L = 2500 mm
13.0900.014.12	14	L = 5000 mm

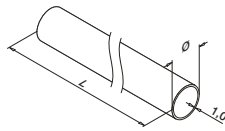

MOD 8925 / 0900

Ø 12 mm

304		
INDOOR	Ø	
13.8925.112.12	12	L = 2500 mm
13.0900.112.12	12	L = 5000 mm

Ø 14 mm

304		
INDOOR	Ø	
13.8925.114.12	14	L = 2500 mm
13.0900.114.12	14	L = 5000 mm



Ø 16 mm

304		
INDOOR	Ø	
13.8925.016.12	16	L = 2500 mm
13.0900.016.12	16	L = 5000 mm

Ø 16 mm

316		
OUTDOOR	Ø	
14.8925.016.12	16	L = 2500 mm
14.0900.016.12	16	L = 5000 mm



Q-INFO

Calculation basis for bars

calculated by ONDRA

	Ø (mm)	A (cm ²)	I _x =I _y (cm ⁴)	W _x =W _y (cm ³)	M (kg/m)	R _{p0,2} (kN/cm ²)	R _m (kN/cm ²)
13.0900.010.12 / 13.8925.010.12	10	0,78	0,05	0,10	0,62	23	54
13.0900.012.12 / 13.8925.012.12	12	1,13	0,10	0,17	0,89	23	54
14.0900.012.12 / 14.8925.012.12	12	1,13	0,10	0,17	0,89	24	53
13.0900.014.12 / 13.8925.014.12	14	1,54	0,19	0,27	1,21	23	54

A = cross sectional area
 I_x / I_y = second moment of area
 W_x / W_y = section modulus
 M = weight
 R_{p0,2} = permissible stress
 R_m = minimum tensile strength

Q-INFO

Calculation basis for tubes

calculated by ONDRA

	Ø (mm)	A (cm ²)	I _x =I _y (cm ⁴)	W _x =W _y (cm ³)	M (kg/m)	R _{p0,2} (kN/cm ²)	R _m (kN/cm ²)
13.0900.112.12 / 13.8925.112.12	12 x 1,0	0,34	0,05	0,09	0,27	23	54
13.0900.114.12 / 13.8925.114.12	14 x 1,0	0,41	0,09	0,12	0,32	23	54
13.0900.016.12 / 13.8925.016.12	16 x 1,0	0,47	0,13	0,17	0,37	23	54
14.0900.016.12 / 14.8925.016.12	16 x 1,0	0,47	0,13	0,17	0,37	24	53

A = cross sectional area
 I_x / I_y = second moment of area
 W_x / W_y = section modulus
 M = weight
 R_{p0,2} = permissible stress
 R_m = minimum tensile strength

Infills

SATIN

Q-LINE - Connectors

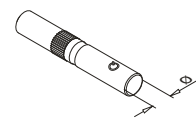
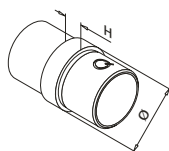

MOD 0790

304

INDOOR	Ø	H	
13.0790.112.12	12 x 1,0	5	4
13.0790.016.12	16 x 1,0	6	4

316

OUTDOOR	Ø	H	
14.0790.016.12	16 x 1,0	6	4



MOD 5792 - EASY HIT®

304

Raw

INDOOR	Ø	
13.5792.112.00	for 12 x 1,0	4



International Design Model Protection

Infills

SATIN

Q-LINE - Connectors, adjustable

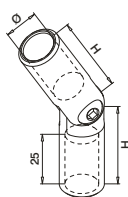
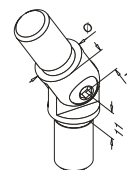
-90°
+90°-90°
+90°

MOD 0302

304

INDOOR	Ø	H	
13.0302.010.12	10	35	6
13.0302.012.12	12	36	6
13.0302.014.12	14	37	6

316

OUTDOOR	Ø	H	
14.0302.012.12	12	36	6



MOD 0302

304

INDOOR	Ø	
13.0302.016.12	16 x 1,0	6

OUTDOOR	Ø	
14.0302.016.12	16 x 1,0	6



Q-INFO



Q-22

Q-ultra-clean
500 ml
19.0610.000.00

Q-INFO

MOD 5792

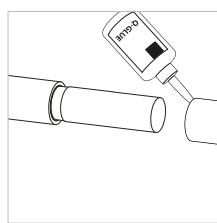
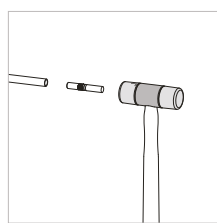

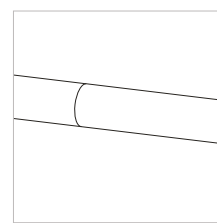

Q-21

Q-glue
50 ml
19.1331.000.00

2

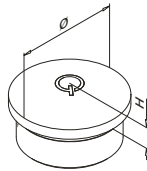
Balustrading
systems

**MOD 0729****304**

INDOOR	Ø	H	
13.0729.016.12	16,0 x 1,0	4	2

316

OUTDOOR	Ø	H	
14.0729.016.12	16,0 x 1,0	4	2

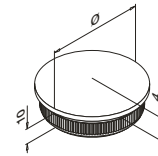
**MOD 5729 - EASY HIT®****304**

INDOOR	Ø	
13.5729.112.12	12 x 1,0	4
13.5729.114.12	14 x 1,0	4

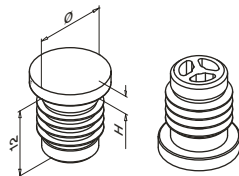
**MOD 5729 - EASY HIT®****ABS plastic**

Stainless steel effect

INDOOR	Ø	H	
24.5729.112.19	12 x 1,0	3	4
24.5729.114.19	14 x 1,0	3	4
24.5729.116.19	16 x 1,0	4	4

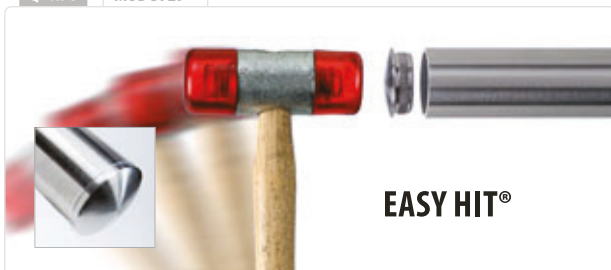

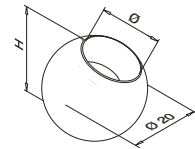
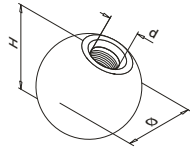
**MOD 0220****304**

INDOOR	Ø	H	d	
13.0220.020.12	20	ca. 18,5	M6	6
13.0220.025.12	25	ca. 23,5	M8	6
13.0220.030.12	30	ca. 28,5	M8	6
13.0220.040.12	40	ca. 38,5	M8	2
13.0220.050.12	50	ca. 48,5	M8	2

316

OUTDOOR	Ø	H	d	
14.0220.020.12	20	ca. 18,5	M6	6
14.0220.025.12	25	ca. 23,5	M8	6
14.0220.040.12	40	ca. 38,5	M8	2

MOD 0221**304**

INDOOR	Ø	H	
13.0221.010.12	10	ca. 18,5	6
13.0221.012.12	12	ca. 17,5	6
13.0221.014.12	14	ca. 16,5	6

316

OUTDOOR	Ø	H	
14.0221.012.12	12	ca. 17,5	6



For bar

**MOD 0735****304**

INDOOR	Ø		
13.0735.012.12	12	QS-5  302	4

316

OUTDOOR	Ø		
14.0735.012.12	12	QS-6  302	4



Q-INFO

MOD 0735

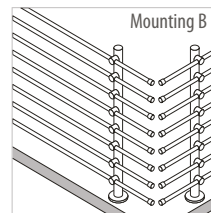
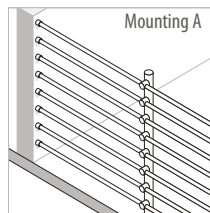
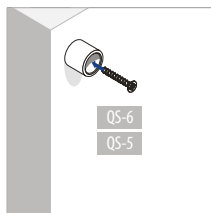
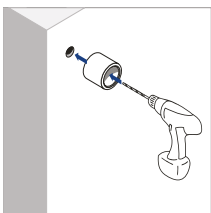

Q-INFO



Q-23

Q-cleaner

300 ml

19.0601.000.00

Q-LINE - Bar holders (adjustable)

Flat - bar

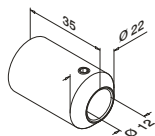

MOD 0850

304

INDOOR	Image	Image
13.0850.000.12	QS-23	303

316

OUTDOOR	Image	Image
14.0850.000.12	QS-53	303



Tube - bar

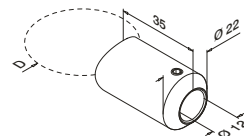

MOD 0850

304

INDOOR	D	Image	Image
13.0850.042.12	Ø 42,4	QS-23	303
13.0850.048.12	Ø 48,3	QS-23	303

316

OUTDOOR	D	Image	Image
14.0850.042.12	Ø 42,4	QS-53	303



Flat - bar

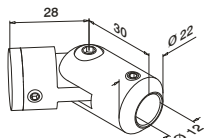

MOD 0855

304

INDOOR	Image	Image
13.0855.000.12	QS-15	303



Tube - bar

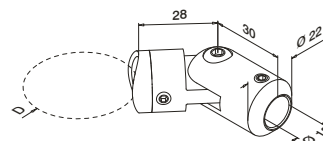

MOD 0855

304

INDOOR	D	Image	Image
13.0855.042.12	Ø 42,4	QS-15	303



Q-INFO

MOD 0850.04x

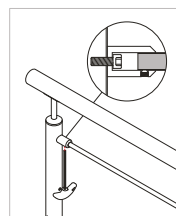
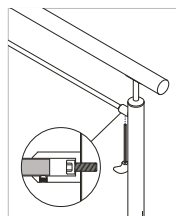
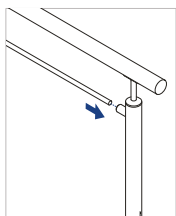
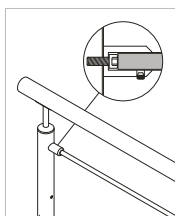
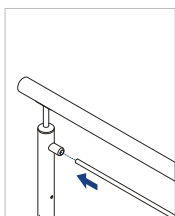
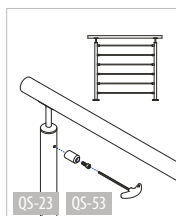

Flat - bar

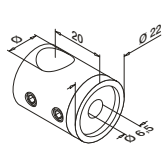

Centre

MOD 0825 - Ø 10 mm

304

INDOOR	Ø		
13.0825.000.12	10	QS-15 303	4

MOD 0830 - Ø 12 mm

304

INDOOR	Ø		
13.0830.000.12	12	QS-15 303	4

316

OUTDOOR	Ø		
14.0830.000.12	12	QS-16 303	4

Zinc

Stainless steel effect

OUTDOOR	Ø		
10.0830.000.20	12	QS-16 303	4



Flat - bar

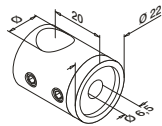

Left

MOD 0832 - Ø 12 mm

304

INDOOR	Ø		
13.0832.000.12	12	QS-15 303	4

316

OUTDOOR	Ø		
14.0832.000.12	12	QS-16 303	4

Zinc

Stainless steel effect

OUTDOOR	Ø		
10.0832.000.20	12	QS-16 303	4



Flat - bar

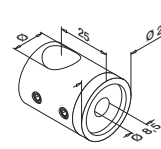

Centre

MOD 0835 - Ø 14 mm

304

INDOOR	Ø		
13.0835.000.12	14	QS-19 303	4

MOD 0840 - Ø 16 mm

304

INDOOR	Ø		
13.0840.000.12	16	QS-19 303	4

316

OUTDOOR	Ø		
14.0840.000.12	16	QS-20 303	4



Flat - bar

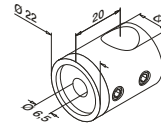

Right

MOD 0833 - Ø 12 mm

304

INDOOR	Ø		
13.0833.000.12	12	QS-15 303	4

316

OUTDOOR	Ø		
14.0833.000.12	12	QS-16 303	4

Zinc

Stainless steel effect

OUTDOOR	Ø		
10.0833.000.20	12	QS-16 303	4



MOD 8925, 0900
150



MOD 8925, 0900
150

Q-INFO

Zinc

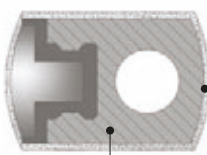

TOP FINISH

Stainless steel effect

Zinc

10.xxxx.xxx.20 = outdoor



Q-INFO



Q-23
Q-cleaner
300 ml
19.0601.000.00

Q-INFO



Q-22
Q-ultra-clean
500 ml
19.0610.000.00

Flat - bar

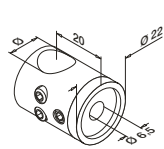

Centre

MOD 0826 - Ø 10 mm

304			
INDOOR	Ø		
13.0826.000.12	10	QS-15 303	4

MOD 0831 - Ø 12 mm

304			
INDOOR	Ø		
13.0831.000.12	12	QS-15 303	4
316			
OUTDOOR	Ø		
14.0831.000.12	12	QS-16 303	4
Zinc			
		Stainless steel effect	
OUTDOOR	Ø		
10.0831.000.20	12	QS-16 303	4



Flat - bar

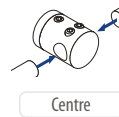
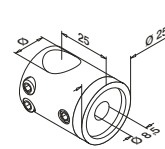

Centre

MOD 0836 - Ø 14 mm

304			
INDOOR	Ø		
13.0836.000.12	14	QS-19 303	4



If you have a specific requirement for pre-assembled products please use our order forms on pages 324 - 336.

Q-INFO

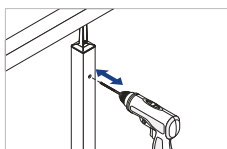

Ø10 / Ø12 = M6
Ø14 = M8

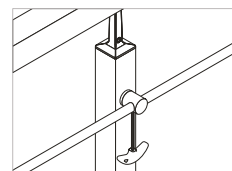
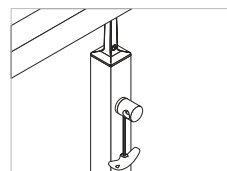
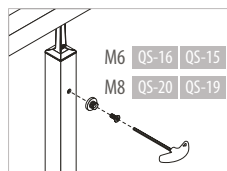
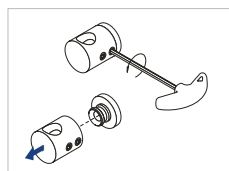

Tube - bar

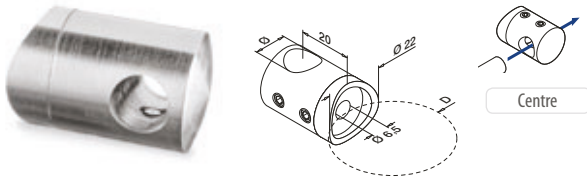

MOD 0825 - Ø 10 mm

304				
INDOOR	Ø	D	Fastener	Qty
13.0825.033.12	10	Ø 33,7	QS-15 303	4
13.0825.042.12	10	Ø 42,4	QS-15 303	4

MOD 0830 - Ø 12 mm

304				
INDOOR	Ø	D	Fastener	Qty
13.0830.033.12	12	Ø 33,7	QS-15 303	4
13.0830.042.12	12	Ø 42,4	QS-15 303	4
13.0830.048.12	12	Ø 48,3	QS-15 303	4

316				
OUTDOOR	Ø	D	Fastener	Qty
14.0830.042.12	12	Ø 42,4	QS-16 303	4
14.0830.048.12	12	Ø 48,3	QS-16 303	4

Zinc				
Stainless steel effect				
OUTDOOR	Ø	D	Fastener	Qty
10.0830.033.20	12	Ø 33,7	QS-16 303	4
10.0830.042.20	12	Ø 42,4	QS-16 303	4



Tube - bar

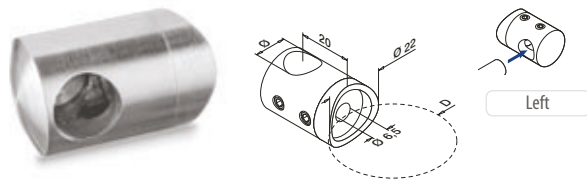

MOD 0832 - Ø 12 mm

304				
INDOOR	Ø	D	Fastener	Qty
13.0832.033.12	12	Ø 33,7	QS-15 303	4
13.0832.042.12	12	Ø 42,4	QS-15 303	4
13.0832.048.12	12	Ø 48,3	QS-15 303	4

316				
OUTDOOR	Ø	D	Fastener	Qty
14.0832.042.12	12	Ø 42,4	QS-16 303	4

Zinc				
Stainless steel effect				
OUTDOOR	Ø	D	Fastener	Qty
10.0832.042.20	12	Ø 42,4	QS-16 303	4



Tube - bar

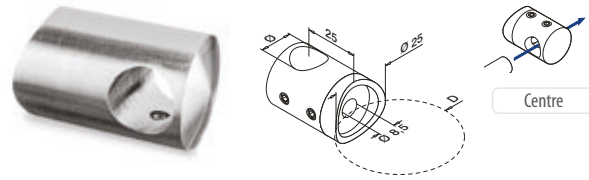

MOD 0835 - Ø 14 mm

304				
INDOOR	Ø	D	Fastener	Qty
13.0835.042.12	14	Ø 42,4	QS-19 303	4
13.0835.048.12	14	Ø 48,3	QS-19 303	4

MOD 0840 - Ø 16 mm

304				
INDOOR	Ø	D	Fastener	Qty
13.0840.042.12	16	Ø 42,4	QS-19 303	4
13.0840.048.12	16	Ø 48,3	QS-19 303	4

316				
OUTDOOR	Ø	D	Fastener	Qty
14.0840.042.12	16	Ø 42,4	QS-20 303	4
14.0840.048.12	16	Ø 48,3	QS-20 303	4



Tube - bar

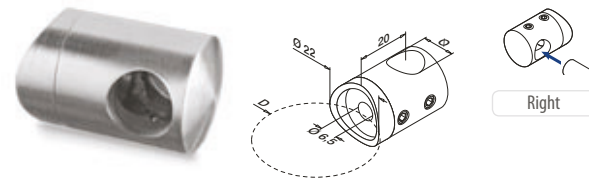

MOD 0833 - Ø 12 mm

304				
INDOOR	Ø	D	Fastener	Qty
13.0833.033.12	12	Ø 33,7	QS-15 303	4
13.0833.042.12	12	Ø 42,4	QS-15 303	4
13.0833.048.12	12	Ø 48,3	QS-15 303	4

316				
OUTDOOR	Ø	D	Fastener	Qty
14.0833.042.12	12	Ø 42,4	QS-16 303	4

Zinc				
Stainless steel effect				
OUTDOOR	Ø	D	Fastener	Qty
10.0833.042.20	12	Ø 42,4	QS-16 303	4



Q-INFO

Zinc



Tube - bar

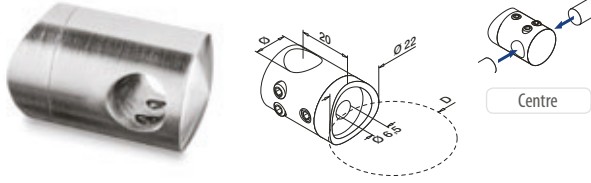

MOD 0826 - Ø 10 mm

304				
INDOOR	Ø	D		
13.0826.033.12	10	Ø 33,7	QS-15 303	4
13.0826.042.12	10	Ø 42,4	QS-15 303	4

MOD 0831 - Ø 12 mm

304				
INDOOR	Ø	D		
13.0831.033.12	12	Ø 33,7	QS-15 303	4
13.0831.042.12	12	Ø 42,4	QS-15 303	4
13.0831.048.12	12	Ø 48,3	QS-15 303	4
316				
OUTDOOR	Ø	D		
14.0831.042.12	12	Ø 42,4	QS-16 303	4
14.0831.048.12	12	Ø 48,3	QS-16 303	4
Zinc				
Stainless steel effect				
OUTDOOR	Ø	D		
10.0831.033.20	12	Ø 33,7	QS-16 303	4
10.0831.042.20	12	Ø 42,4	QS-16 303	4
10.0831.048.20	12	Ø 48,3	QS-16 303	4



Bar - bar



MOD 0840 - Ø 16 mm

304			
INDOOR	Ø	D	
13.0840.016.12	16	Ø 16	4



Bar - bar



MOD 0830 - Ø 12 mm

304			
INDOOR	Ø	D	
13.0830.012.12	12	Ø 12	4
13.0830.016.12	12	Ø 16	4



Tube - bar

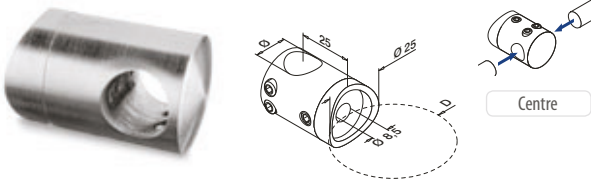

MOD 0836 - Ø 14 mm

304				
INDOOR	Ø	D		
13.0836.042.12	14	Ø 42,4	QS-19 303	4



Q-INFO MOD 0830 / 0840

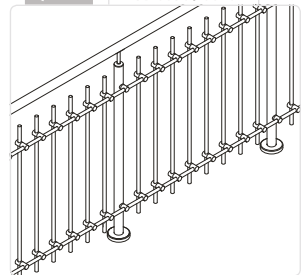

Q-INFO MOD 0826 / 0831 / 0836

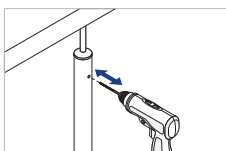

Ø10 / Ø12 = M6
Ø14 = M8

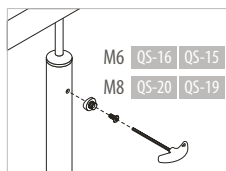
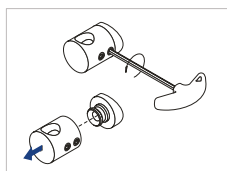

M6 QS-16 QS-15
M8 QS-20 QS-19

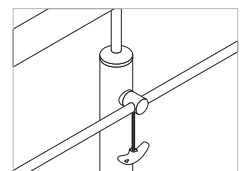
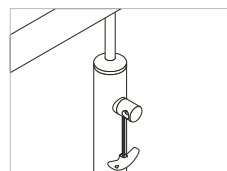

Outer corner

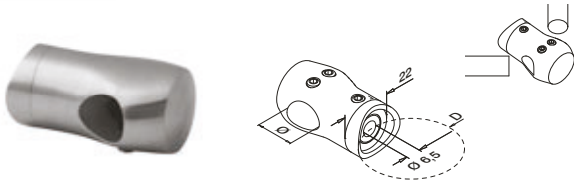

MOD 0839 - Ø 12 mm

304				
INDOOR	Ø	D		
13.0839.042.12	12	Ø 42,4	QS-15	303 4
13.0839.048.12	12	Ø 48,3	QS-15	303 4
316				
OUTDOOR	Ø	D		
14.0839.042.12	12	Ø 42,4	QS-16	303 4
14.0839.048.12	12	Ø 48,3	QS-16	303 4



International Design Model Protection

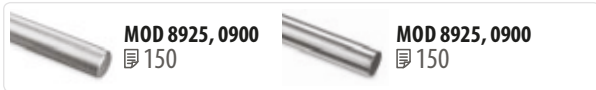

Inner corner

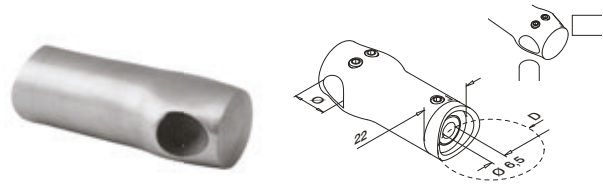

MOD 0834 - Ø 12 mm

304				
INDOOR	Ø	D		
13.0834.042.12	12	Ø 42,4	QS-15	303 4
13.0834.048.12	12	Ø 48,3	QS-15	303 4
316				
OUTDOOR	Ø	D		
14.0834.042.12	12	Ø 42,4	QS-16	303 4
14.0834.048.12	12	Ø 48,3	QS-16	303 4



International Design Model Protection

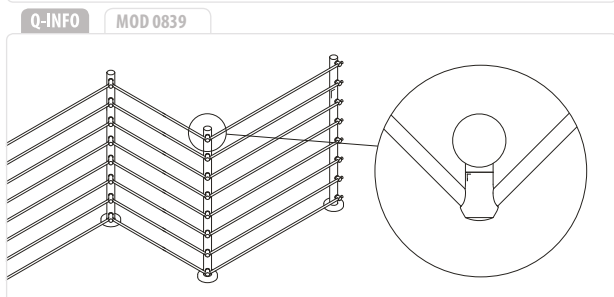
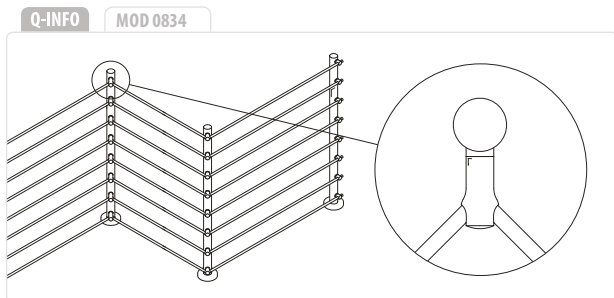



CABLE INFILLS

Choose from two types of cable infill, varying in cable thickness, material and installation method. Both ensure you achieve straight horizontal lines in your baluster railing system and both are easy to install.



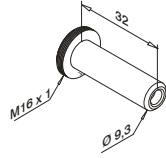

MOD 7240

316

OUTDOOR

14.7240.003.12



2

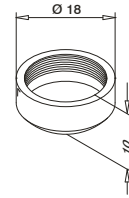

MOD 5010

316

OUTDOOR

14.5010.000.12



8

Complete set



Ø 3,2 mm = (1 x 19)

MOD 7901

316

OUTDOOR

	Ø	L
14.7901.013.12	3,2	L = 1 m
14.7901.023.12	3,2	L = 2,5 m
14.7901.053.12	3,2	L = 5 m
14.7901.073.12	3,2	L = 7,5 m
14.7901.103.12	3,2	L = 10 m
14.7901.123.12	3,2	L = 12,5 m
14.7901.203.12	3,2	L = 20 m



Fast Fix release tool

MOD 7802

316

OUTDOOR

14.7802.003.00



1

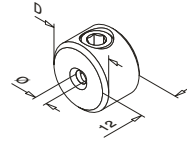

MOD 7400

304

INDOOR

	Ø	D	L
13.7400.003.12	3,5	18	6
13.7400.006.12	6,5	20	6
316			
OUTDOOR			
	Ø	D	L
14.7400.003.12	3,5	18	6
14.7400.006.12	6,5	20	6



Q-INFO

Installation order

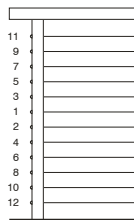

Q-INFO

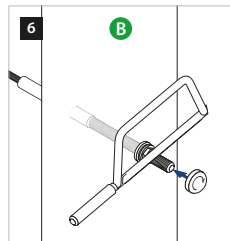
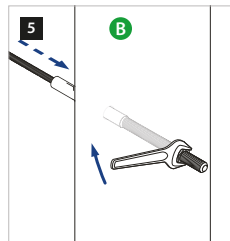
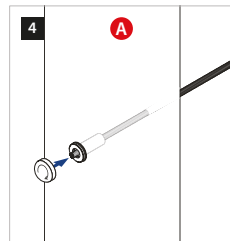
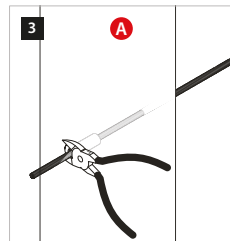
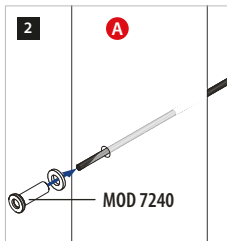
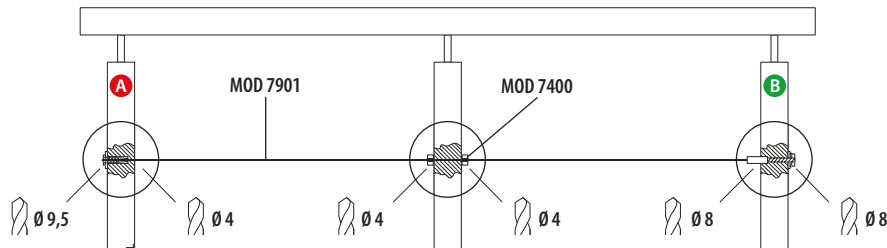

Flat - cable

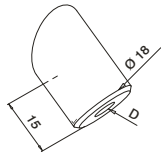

Downwards
+/- 35°

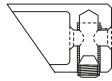

MOD 7401

304

INDOOR	D	
13.7401.300.12	3,2 / 4	6

316

OUTDOOR	D	
14.7401.300.12	3,2 / 4	6

NEW



Tube - cable

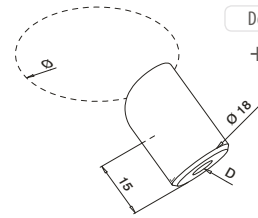

Downwards
+/- 35°

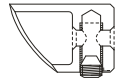

MOD 7401

304

INDOOR	D	Ø	
13.7401.342.12	3,2 / 4	42,4	6
13.7401.348.12	3,2 / 4	48,3	6

316

OUTDOOR	D	Ø	
14.7401.342.12	3,2 / 4	42,4	6
14.7401.348.12	3,2 / 4	48,3	6

NEW



Flat - cable

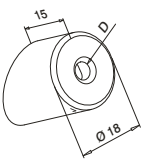

Upwards
+/- 35°

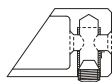

MOD 7402

304

INDOOR	D	
13.7402.300.12	3,2 / 4	6

316

OUTDOOR	D	
14.7402.300.12	3,2 / 4	6

NEW



Tube - cable

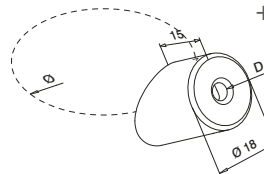

Upwards
+/- 35°

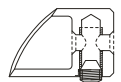

MOD 7402

304

INDOOR	D	Ø	
13.7402.342.12	3,2 / 4	42,4	6
13.7402.348.12	3,2 / 4	48,3	6

316

OUTDOOR	D	Ø	
14.7402.342.12	3,2 / 4	42,4	6
14.7402.348.12	3,2 / 4	48,3	6

NEW



Flat - cable

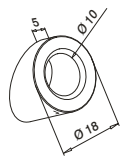

+/- 35°



MOD 7403

304

INDOOR	
13.7403.300.12	6

316

OUTDOOR	
14.7403.300.12	6

NEW

Tube - cable

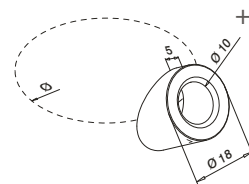

+/- 35°



MOD 7403

304

INDOOR	Ø	
13.7403.342.12	42,4	6
13.7403.348.12	48,3	6

316

OUTDOOR	Ø	
14.7403.342.12	42,4	6
14.7403.348.12	48,3	6

NEW

Q-INFO

MOD 7401.34x / 7402.34x / 7403.34x

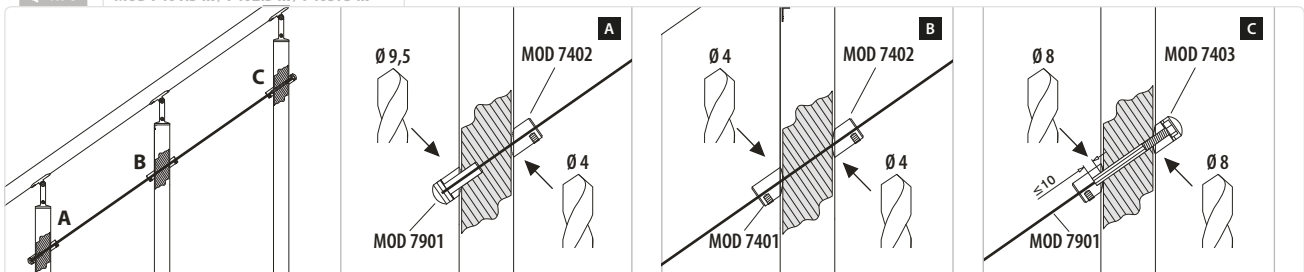

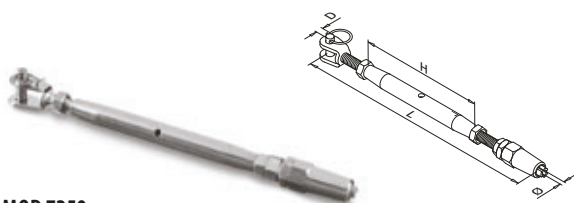
**MOD 7250****304**

INDOOR	∅	D	H	L	
13.7250.003.12	3,2	6	90	155 - 230	2
13.7250.006.12	6,0	9	125	270 - 325	2

316

OUTDOOR	∅	D	H	L	
14.7250.003.12	3,2	6	90	155 - 230	2
14.7250.006.12	6,0	9	125	270 - 325	2

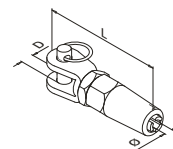
**MOD 7300****304**

INDOOR	∅	D	L	
13.7300.003.12	3,2	6	50	2
13.7300.006.12	6,0	9	97	2

316

OUTDOOR	∅	D	L	
14.7300.003.12	3,2	6	50	2
14.7300.006.12	6,0	9	97	2

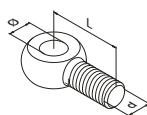
**MOD 7350****304**

INDOOR	d	∅	L	
13.7350.003.12	M6	6	19	10
13.7350.006.12	M10	9,5	30	10

316

OUTDOOR	d	∅	L	
14.7350.003.12	M6	6	19	10
14.7350.006.12	M10	9,5	30	10

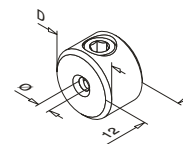
**MOD 7400****304**

INDOOR	∅	D	
13.7400.003.12	3,5	18	6
13.7400.006.12	6,5	20	6

316

OUTDOOR	∅	D	
14.7400.003.12	3,5	18	6
14.7400.006.12	6,5	20	6



∅ 3,2 mm = (1 x 19)

∅ 6,0 mm = (7 x 19)

MOD 7900**304**

INDOOR	∅	
13.7900.003.12	3,2	L = 10 m
13.7900.053.12	3,2	L = 50 m
13.7900.103.12	3,2	L = 100 m
13.7900.006.12	6,0	L = 10 m
13.7900.056.12	6,0	L = 50 m
13.7900.106.12	6,0	L = 100 m

316

OUTDOOR	∅	
14.7900.003.12	3,2	L = 10 m
14.7900.053.12	3,2	L = 50 m
14.7900.103.12	3,2	L = 100 m
14.7900.006.12	6,0	L = 10 m
14.7900.056.12	6,0	L = 50 m
14.7900.106.12	6,0	L = 100 m



Cable cutter

MOD 7800**Accessories**

	Q	∅	
14.7800.000.00	Q-39	1,5 + 3,2	1

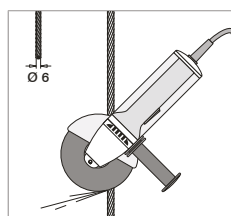
Q-INFO MOD 7900.xx6**Q-INFO****Q-22**Q-ultra-clean
500 ml
19.0610.000.00

Q-INFO

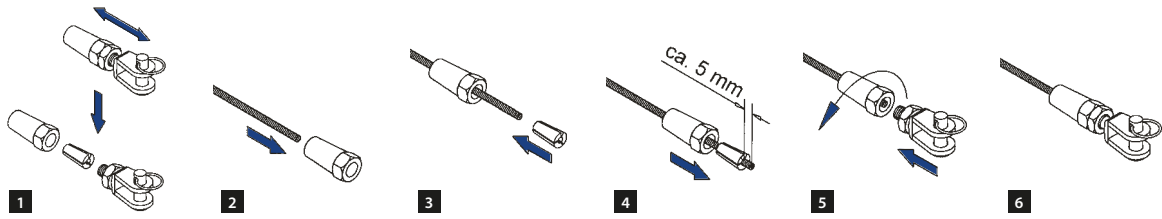

Q-INFO

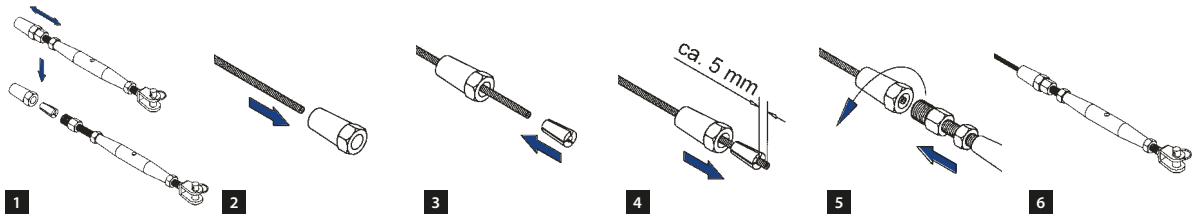

Q-INFO

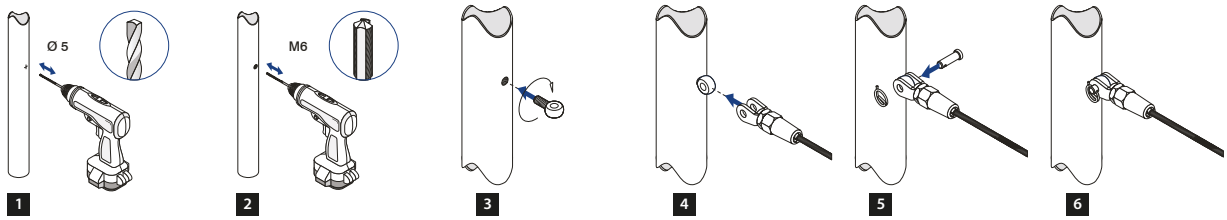

Q-INFO

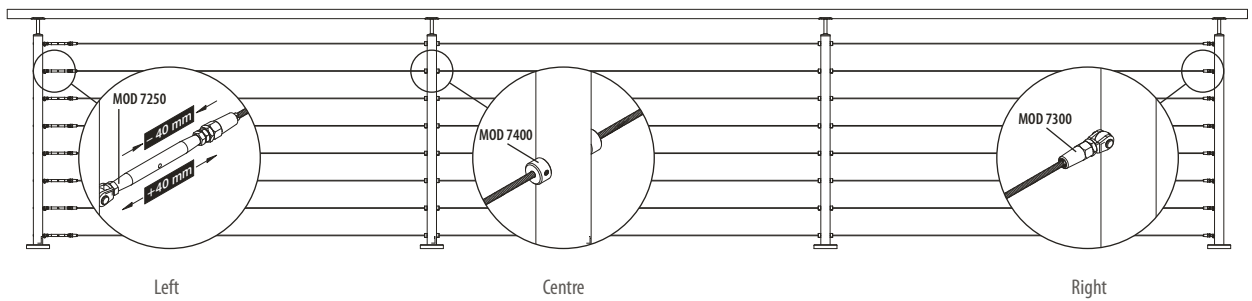

Flat - cable

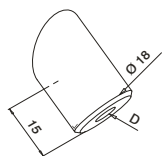

Downwards

+/- 35°

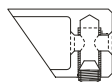

MOD 7401

304

INDOOR	D	
13.7401.300.12	3,2 / 4	6

316

OUTDOOR	D	
14.7401.300.12	3,2 / 4	6



Tube - cable

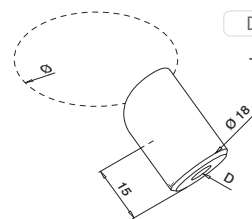

Downwards

+/- 35°

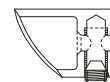

MOD 7401

304

INDOOR	D	Ø	
13.7401.342.12	3,2 / 4	42,4	6
13.7401.348.12	3,2 / 4	48,3	6

316

OUTDOOR	D	Ø	
14.7401.342.12	3,2 / 4	42,4	6
14.7401.348.12	3,2 / 4	48,3	6



Flat - cable

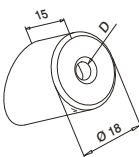

Upwards

+/- 35°

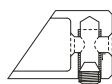

MOD 7402

304

INDOOR	D	
13.7402.300.12	3,2 / 4	6

316

OUTDOOR	D	
14.7402.300.12	3,2 / 4	6



Tube - cable

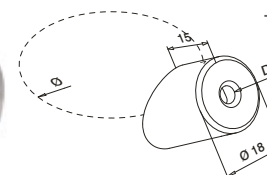
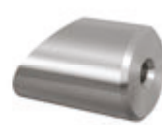

Upwards

+/- 35°

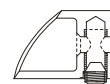

MOD 7402

304

INDOOR	D	Ø	
13.7402.342.12	3,2 / 4	42,4	6
13.7402.348.12	3,2 / 4	48,3	6

316

OUTDOOR	D	Ø	
14.7402.342.12	3,2 / 4	42,4	6
14.7402.348.12	3,2 / 4	48,3	6



Q-INFO

MOD 7401.34x / 7402.34x

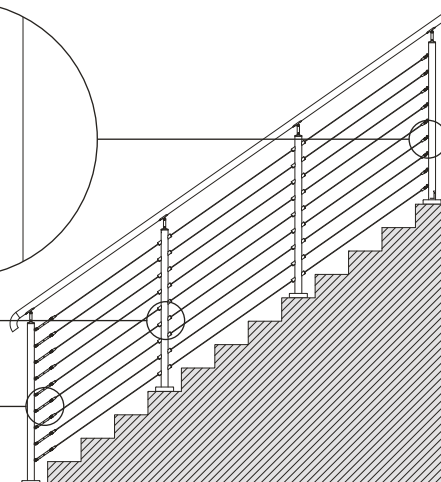
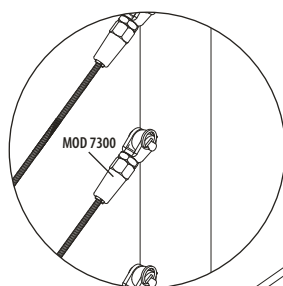
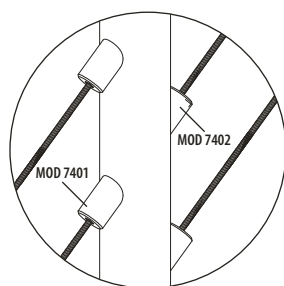
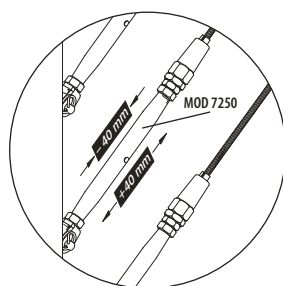

Flat - cable

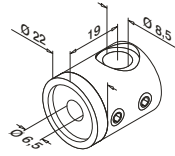

Left

MOD 7452

304		
INDOOR		
13.7452.000.12	QS-15 303	4
316		
OUTDOOR		
14.7452.000.12	QS-16 303	4



Flat - cable

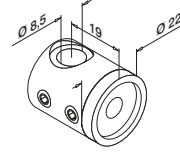

Right

MOD 7453

304		
INDOOR		
13.7453.000.12	QS-15 303	4
316		
OUTDOOR		
14.7453.000.12	QS-16 303	4



Flat - cable

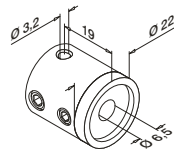

Centre

MOD 7450

304		
INDOOR		
13.7450.000.12	QS-15 303	4
316		
OUTDOOR		
14.7450.000.12	QS-16 303	4

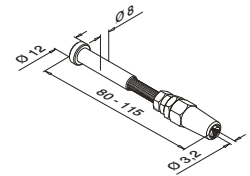

MOD 7500

304	
INDOOR	
13.7500.003.12	4
316	
OUTDOOR	
14.7500.003.12	4



Q-INFO

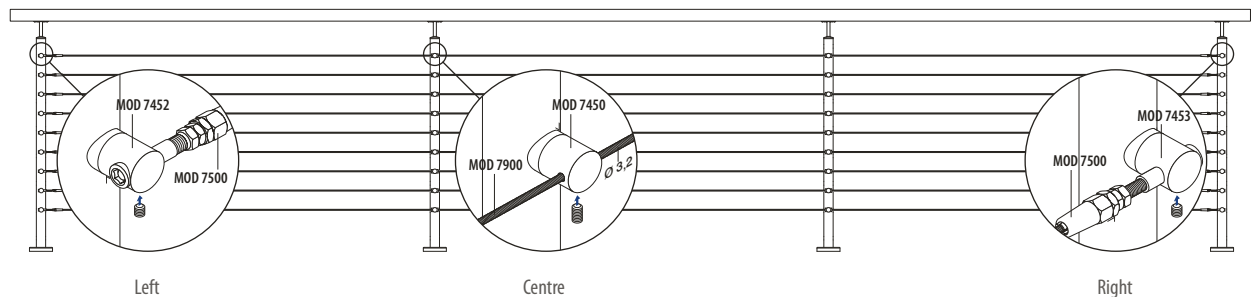

Left

Centre

Right

Tube - cable

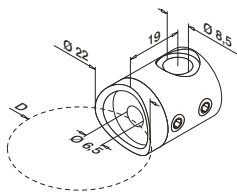

Left

MOD 7452

304

INDOOR	D		
13.7452.042.12	Ø 42,4	QS-15 303	4
13.7452.048.12	Ø 48,3	QS-15 303	4

316

OUTDOOR	D		
14.7452.042.12	Ø 42,4	QS-16 303	4



Tube - cable

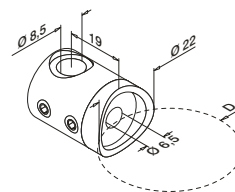

Right

MOD 7453

304

INDOOR	D		
13.7453.042.12	Ø 42,4	QS-15 303	4
13.7453.048.12	Ø 48,3	QS-15 303	4

316

OUTDOOR	D		
14.7453.042.12	Ø 42,4	QS-16 303	4



Tube - cable

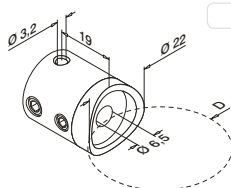

Centre

MOD 7450

304

INDOOR	D		
13.7450.042.12	Ø 42,4	QS-15 303	4
13.7450.048.12	Ø 48,3	QS-15 303	4

316

OUTDOOR	D		
14.7450.042.12	Ø 42,4	QS-16 303	4



Q-INFO



Q-23

Q-cleaner
300 ml
19.0601.000.00

Q-INFO



Q-22

Q-ultra-clean
500 ml
19.0610.000.00

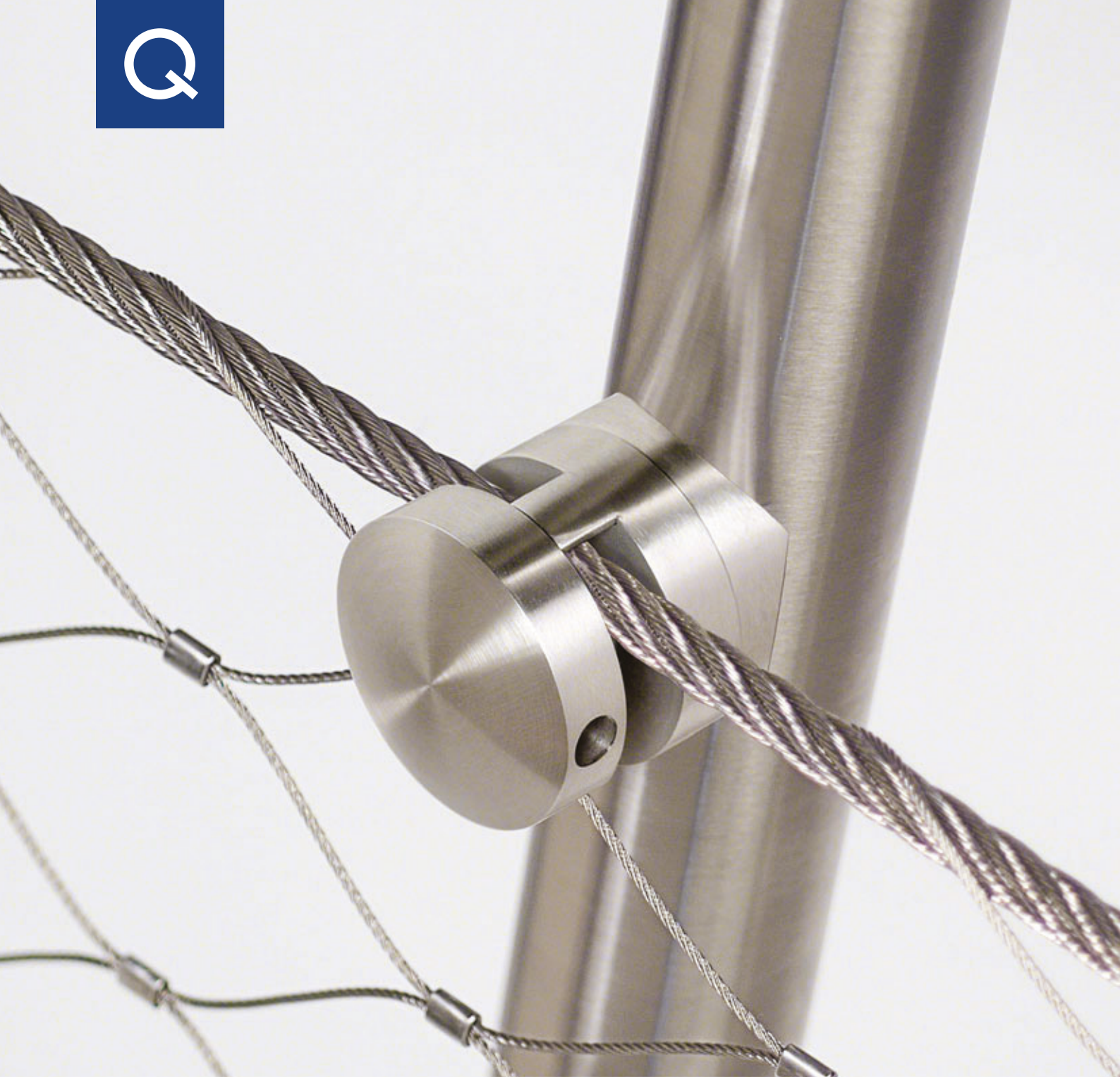

EASY Q-WEB®

Q-railing's web infill is called Easy Q-web®. Use it to create a striking and elegant railing system. Each 1.5 mm diameter cable in this ready-to-use web is made of seven stainless steel 316 wires, twisted together for extra strength. Easy Q-web is available in heights of 600 and 800 mm and widths of 5, 10, and 50 m. You'll be able to easily cut these widths to the exact size you need.



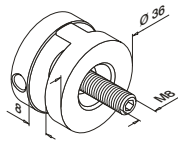

MOD 7356

316

OUTDOOR

14.7356.000.12	2
----------------	---

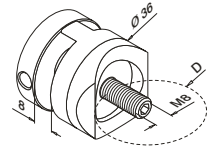

MOD 7356

316

OUTDOOR

14.7356.042.12	D	Ø 42,4	2
----------------	---	--------	---

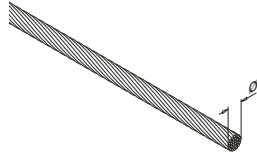

Ø 6,0 mm = (7 x 19)

MOD 7900

316

OUTDOOR

14.7900.006.12	6	L = 10 m
14.7900.056.12	6	L = 50 m
14.7900.106.12	6	L = 100 m

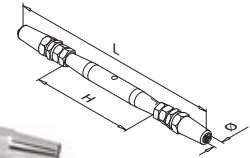

MOD 7260

316

OUTDOOR

14.7260.006.12	6	H	L	2
----------------	---	---	---	---

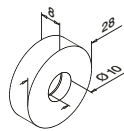

MOD 7723

316

OUTDOOR

14.7723.000.12	12
----------------	----

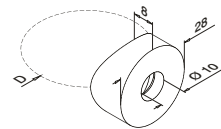

MOD 7723

316

OUTDOOR

14.7723.042.12	D	12
14.7723.048.12	48,3	12



MOD 0712

Accessories

19.0712.300.00	Q	L	100
	Q-50	300 mm	

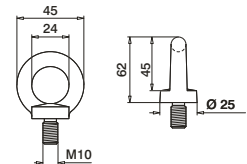

MOD 7355

316

OUTDOOR

14.7355.010.12	12
----------------	----

Q-INFO MOD 7900.xx6

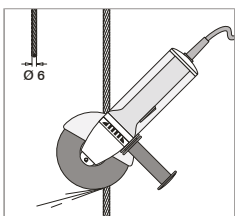

Q-INFO MOD 7356

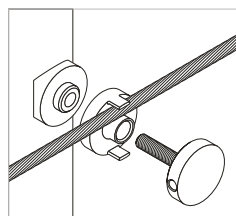

Q-INFO



Q-22

Q-ultra-clean
500 ml
19.0610.000.00

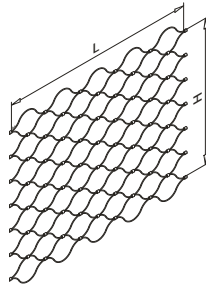
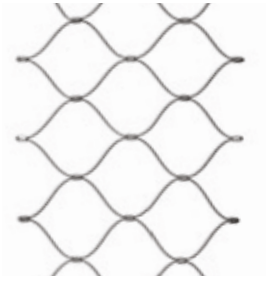
**MOD 7906**

316

OUTDOOR

	H	
14.7906.051.12	600	L = 5 m
14.7906.101.12	600	L = 10 m
14.7906.501.12	600	L = 50 m

MOD 7908

316

OUTDOOR

	H	
14.7908.051.12	800	L = 5 m
14.7908.101.12	800	L = 10 m
14.7908.501.12	800	L = 50 m



∅ 1,5 mm =  (7 x 7)

MOD 7900

316

OUTDOOR

	∅	
14.7900.001.12	1,5	L = 10 m
14.7900.051.12	1,5	L = 50 m
14.7900.101.12	1,5	L = 100 m



Cable cutter

MOD 7800

Accessories

	Q	∅	
14.7800.000.00	Q-39	1,5 + 3,2	1

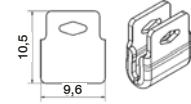
**MOD 7810**

316

OUTDOOR

14.7810.001.12	12

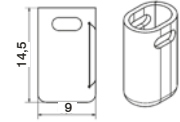
**MOD 7820**

316

OUTDOOR

14.7820.001.12	12

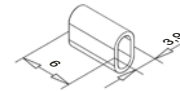
**MOD 7830**

316

OUTDOOR

14.7830.001.12	12

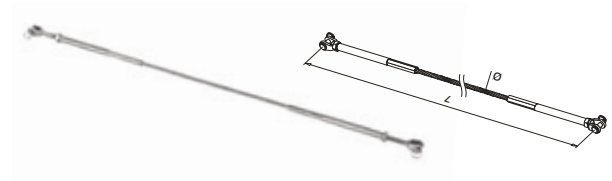
**MOD 7780**

316

OUTDOOR

	∅	L	
14.7780.008.12	8	800 mm	1

Q-INFO

MOD 7260 / 7810 / 7820

Necessary amount

MOD 7260		1x per 10 metre
MOD 7810		20 pieces per metre (10x top and 10x base)
MOD 7820	H = 600 mm	10 pieces each side (left end and right end)
	H = 800 mm	13 pieces each side (left end and right end)

Q-INFO



Q-22

Q-ultra-clean
500 ml
19.0610.000.00

Q-INFO

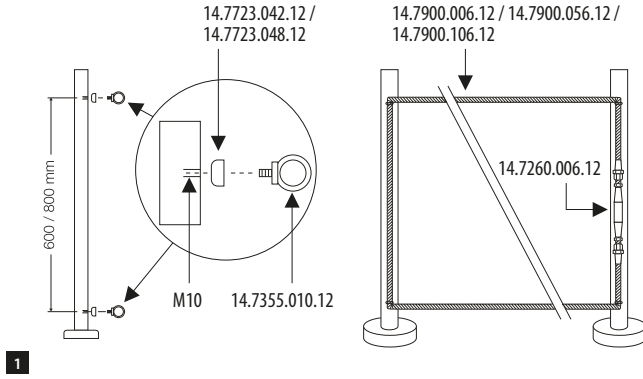

1

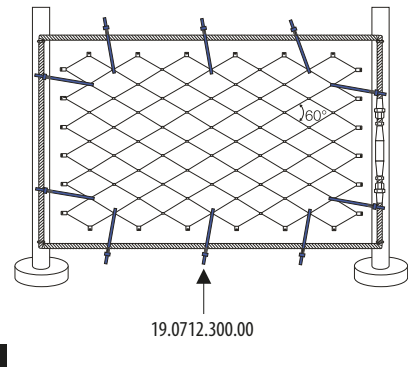

2

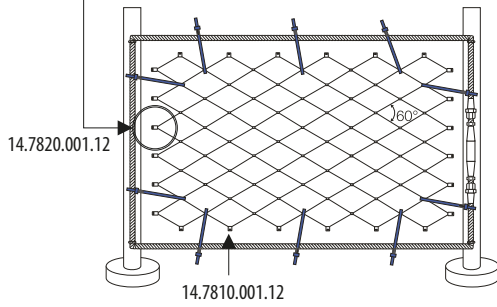
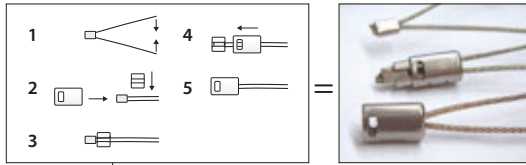

3

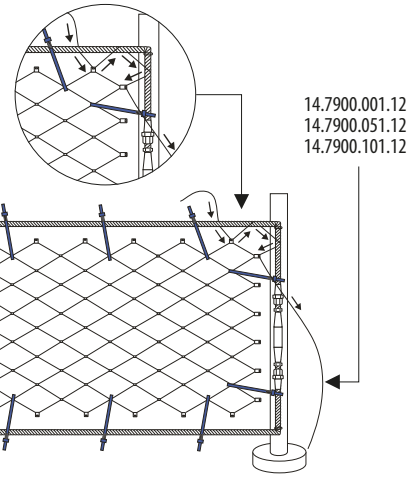

4

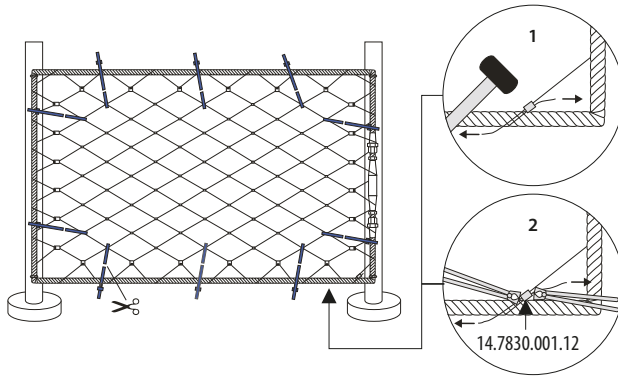

5

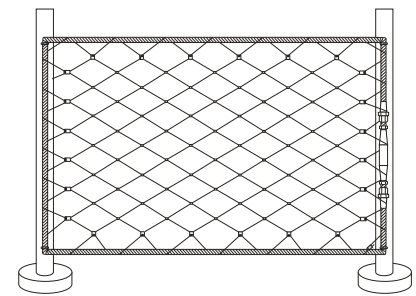

6

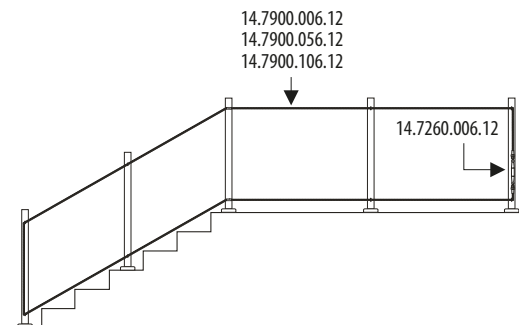

I

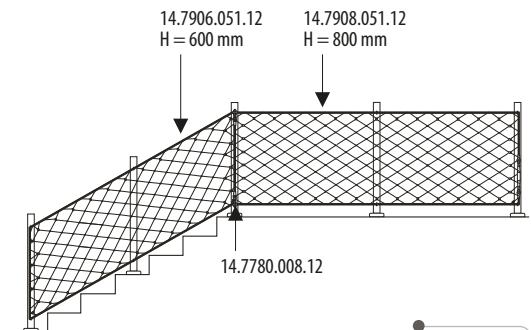

II



Flat - plate

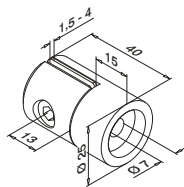

MOD 0743

304			
INDOOR			
13.0743.000.12	QS-17	303	4
316			
OUTDOOR			
14.0743.000.12	QS-18	303	4



Tube - plate

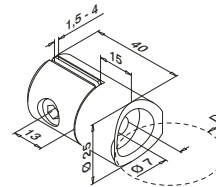

MOD 0743

304				
INDOOR				
	D			
13.0743.033.12	Ø 33,7	QS-17	303	4
13.0743.042.12	Ø 42,4	QS-17	303	4
13.0743.048.12	Ø 48,3	QS-17	303	4
316				
OUTDOOR				
	D			
14.0743.042.12	Ø 42,4	QS-18	303	4
14.0743.048.12	Ø 48,3	QS-18	303	4



Q-INFO



Q-23
Q-cleaner
300 ml
19.0601.000.00

Q-INFO



Q-22
Q-ultra-clean
500 ml
19.0610.000.00

Flat - plate

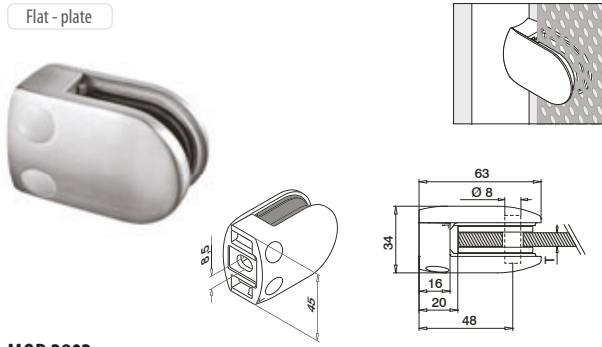

MOD 2802

304				
INDOOR	T			
13.2802.000.12	2	QS-47	301	4

316				
OUTDOOR	T			
14.2802.000.12	2	QS-45	301	4

MOD 2803

304				
INDOOR	T			
13.2803.000.12	3	QS-47	301	4

316				
OUTDOOR	T			
14.2803.000.12	3	QS-45	301	4

MOD 2804

304				
INDOOR	T			
13.2804.000.12	4	QS-47	301	4

316				
OUTDOOR	T			
14.2804.000.12	4	QS-45	301	4



International Design Model Protection



Tube - plate

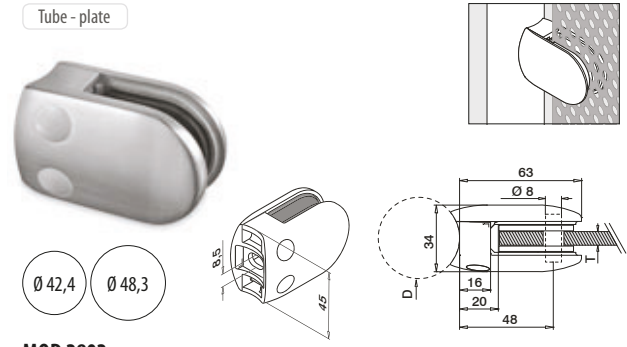

MOD 2802

304				
INDOOR	D	T		
13.2802.042.12	Ø 42,4	2	QS-47	301 4
13.2802.048.12	Ø 48,3	2	QS-47	301 4

316				
OUTDOOR	D	T		
14.2802.042.12	Ø 42,4	2	QS-45	301 4
14.2802.048.12	Ø 48,3	2	QS-45	301 4

MOD 2803

304				
INDOOR	D	T		
13.2803.042.12	Ø 42,4	3	QS-47	301 4
13.2803.048.12	Ø 48,3	3	QS-47	301 4

316				
OUTDOOR	D	T		
14.2803.042.12	Ø 42,4	3	QS-45	301 4
14.2803.048.12	Ø 48,3	3	QS-45	301 4

MOD 2804

304				
INDOOR	D	T		
13.2804.042.12	Ø 42,4	4	QS-47	301 4
13.2804.048.12	Ø 48,3	4	QS-47	301 4

316				
OUTDOOR	D	T		
14.2804.042.12	Ø 42,4	4	QS-45	301 4
14.2804.048.12	Ø 48,3	4	QS-45	301 4



International Design Model Protection

Accessories

Security pins for plate adapters



MOD 5015

Accessories				
For MOD	L			
19.5015.022.00	2802, 2803, 2804	22		4

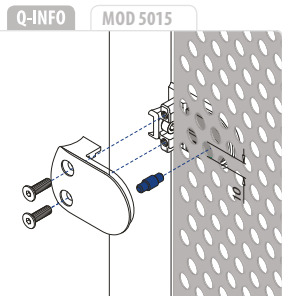

Please order security pins and fixing bolts separately.

Q-LINE - Plate adapters

Flat

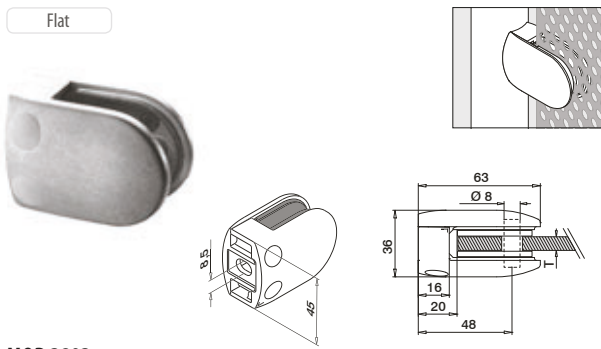

MOD 2802

Zinc			
INDOOR	T		
10.2802.000...	2	QS-46	301 4

MOD 2803

Zinc			
INDOOR	T		
10.2803.000...	3	QS-46	301 4

MOD 2804

Zinc			
INDOOR	T		
10.2804.000...	4	QS-46	301 4



International Design Model Protection

Tube

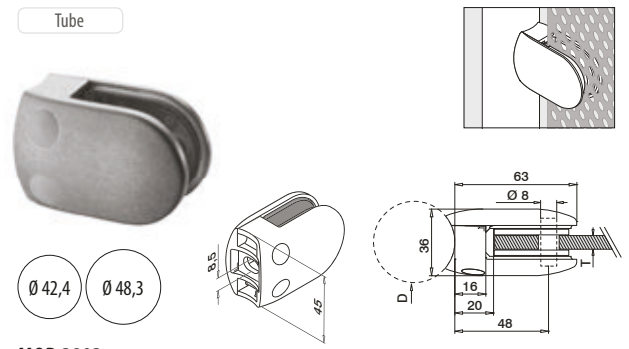

MOD 2802

Zinc				
INDOOR	D	T		
10.2802.042...	Ø 42,4	2	QS-46	301 4
10.2802.048...	Ø 48,3	2	QS-46	301 4

MOD 2803

Zinc				
INDOOR	D	T		
10.2803.042...	Ø 42,4	3	QS-46	301 4
10.2803.048...	Ø 48,3	3	QS-46	301 4

MOD 2804

Zinc				
INDOOR	D	T		
10.2804.042...	Ø 42,4	4	QS-46	301 4
10.2804.048...	Ø 48,3	4	QS-46	301 4



International Design Model Protection

Accessories

Security pins for plate adapters



MOD 5015

Accessories			
	For MOD	L	
19.5015.022.00	2802, 2803, 2804	22	4

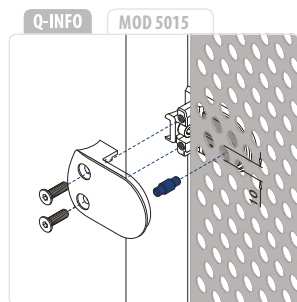

Flat

Q-INFO Zinc MOD 280x Finishes

Raw	Matt chrome	Chrome plated	Stainless steel effect
10.28.....00	10.28.....16	10.28.....17	10.28.....19

Tube

Q-INFO Zinc MOD 280x Finishes

Raw	Chrome plated	Stainless steel effect
10.28.....00	10.28.....17	10.28.....19

Please order security pins and fixing bolts separately.

Wall - tube

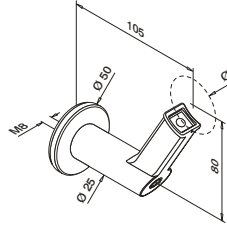
**MOD 9320****304**

INDOOR	Ø			
13.9320.042.12	42,4	QS-1	QS-25	303
13.9320.048.12	48,3	QS-1	QS-25	303

316

OUTDOOR	Ø			
14.9320.042.12	42,4	QS-2	QS-71	303
14.9320.048.12	48,3	QS-2	QS-71	303

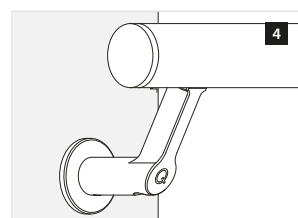
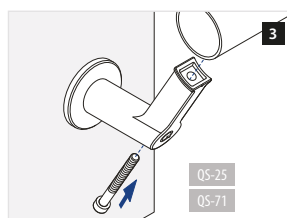
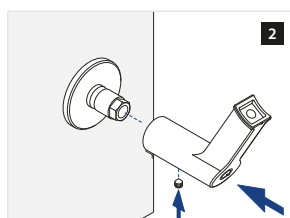
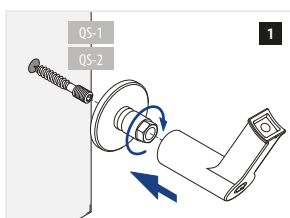
**Q-INFO**

Q-LINE - Handrail brackets

Wall - flat

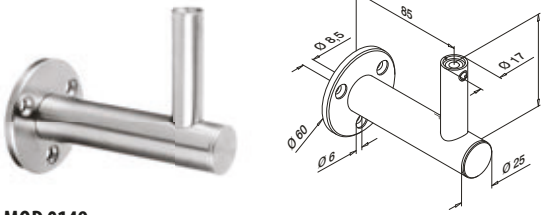

MOD 0149

304			
INDOOR			
13.0149.000.12	QS-556 □ 302 / QS-555 □ 305		2
	QS-7 □ 302 / QS-24 □ 303 / QS-87 □ 305		



International Design Model Protection

Wall - tube

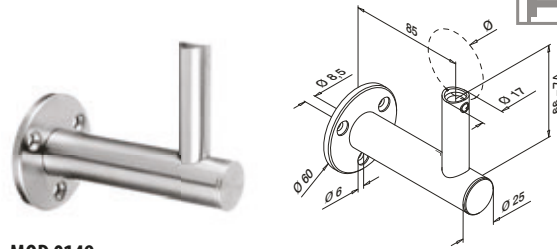

MOD 0149

304			
INDOOR			
13.0149.044.12	42,4 / 48,3	QS-556 □ 302 / QS-555 □ 305	2
		QS-7 □ 302 / QS-24 □ 303 / QS-87 □ 305	

316			
OUTDOOR			
14.0149.044.12	42,4 / 48,3	QS-556 □ 302 / QS-555 □ 305 / QS-50 □ 302 / QS-71 □ 303 / QS-87 □ 305	2



International Design Model Protection

Posts

SATIN

Q-LINE - Cover caps



MOD 0520

304	
INDOOR	
13.0520.066.12	2
316	
OUTDOOR	
14.0520.066.12	2

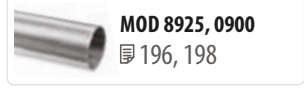

MOD 8925, 0900
□ 196, 198

Q-INFO MOD 0149

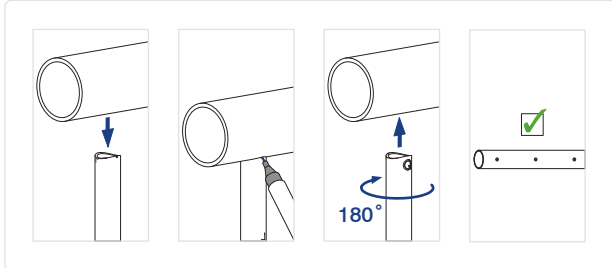

Q-INFO MOD 0520

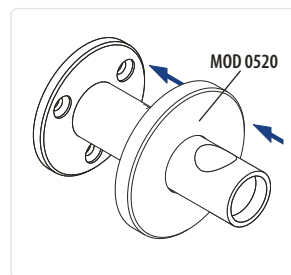

Q-INFO MOD 0149

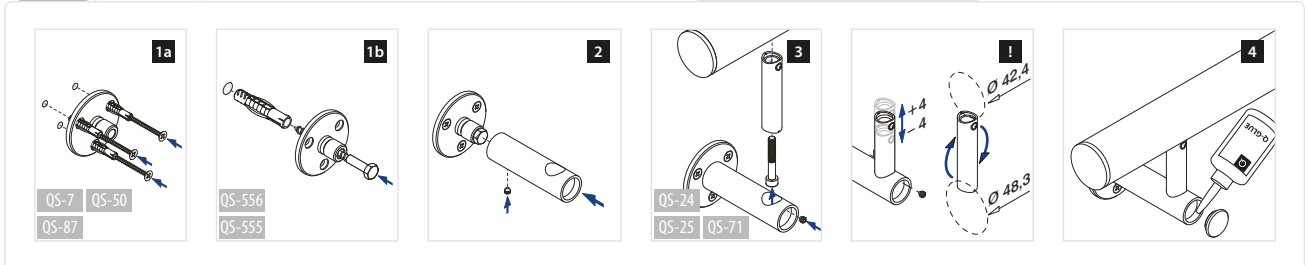

Q-LINE - Handrail brackets, adjustable

Wall - flat

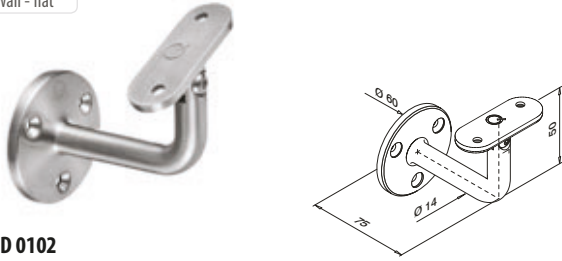

MOD 0102

304

INDOOR			
13.0102.000.12	QS-7 302 / QS-12 303 / QS-87 305		2

316

OUTDOOR			
14.0102.000.12	QS-50 302 / QS-13 303 / QS-87 305		2



Wall - tube

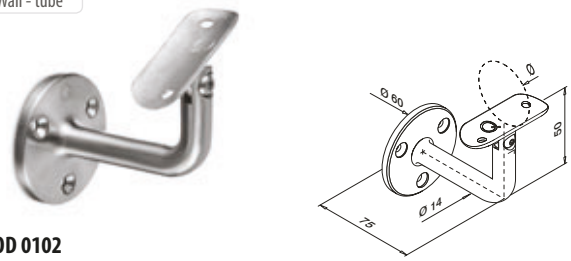

MOD 0102

304

INDOOR		Ø		
13.0102.042.12	42,4	QS-7 302 / QS-10 302 / QS-87 305		2
13.0102.048.12	48,3	QS-7 302 / QS-10 302 / QS-87 305		2

316

OUTDOOR		Ø		
14.0102.042.12	42,4	QS-50 302 / QS-11 302 / QS-87 305		2
14.0102.048.12	48,3	QS-50 302 / QS-11 302 / QS-87 305		2



Q-INFO

MOD 0102

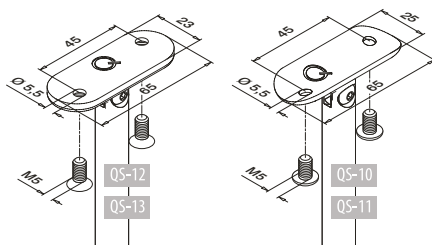

Wall - flat

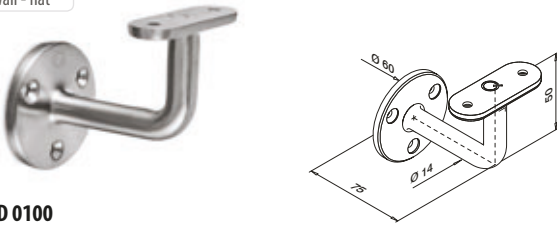

MOD 0100

304

INDOOR

13.0100.000.12	QS-7	Ø 302	QS-12	Ø 303	QS-87	Ø 305	2
----------------	------	-------	-------	-------	-------	-------	---

316

OUTDOOR

14.0100.000.12	QS-50	Ø 302	QS-13	Ø 303	QS-87	Ø 305	2
----------------	-------	-------	-------	-------	-------	-------	---



Wall - tube

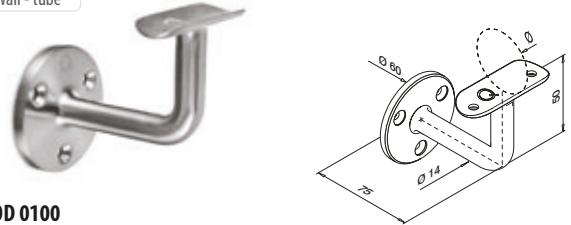

MOD 0100

304

INDOOR

13.0100.042.12	42,4	QS-7	Ø 302	QS-10	Ø 302	QS-87	Ø 305	2
13.0100.048.12	48,3	QS-7	Ø 302	QS-10	Ø 302	QS-87	Ø 305	2

316

OUTDOOR

14.0100.042.12	42,4	QS-50	Ø 302	QS-11	Ø 302	QS-87	Ø 305	2
14.0100.048.12	48,3	QS-50	Ø 302	QS-11	Ø 302	QS-87	Ø 305	2



Wall - flat

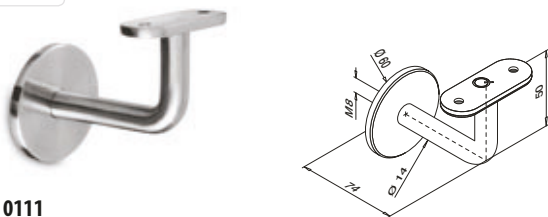

MOD 0111

304

INDOOR

13.0111.000.12	QS-1	Ø 302	QS-12	Ø 303			2
----------------	------	-------	-------	-------	--	--	---

316

OUTDOOR

14.0111.000.12	QS-2	Ø 302	QS-13	Ø 303			2
----------------	------	-------	-------	-------	--	--	---



Wall - tube

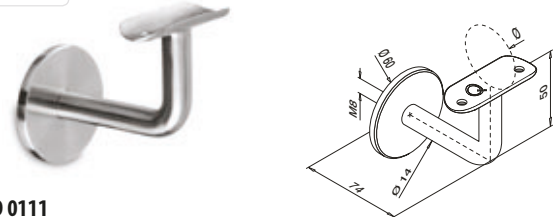

MOD 0111

304

INDOOR

13.0111.033.12	33,7	QS-1	Ø 302	QS-10	Ø 302		2
13.0111.042.12	42,4	QS-1	Ø 302	QS-10	Ø 302		2
13.0111.048.12	48,3	QS-1	Ø 302	QS-10	Ø 302		2

316

OUTDOOR

14.0111.042.12	42,4	QS-2	Ø 302	QS-11	Ø 302		2
14.0111.048.12	48,3	QS-2	Ø 302	QS-11	Ø 302		2

For more information, please visit our website: www.q-railing.com

Q-INFO

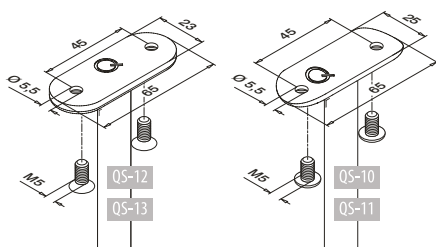

Q-INFO



Q-23
Q-cleaner
300 ml
19.0601.000.00

Q-INFO



Q-22
Q-ultra-clean
500 ml
19.0610.000.00

Wall - flat

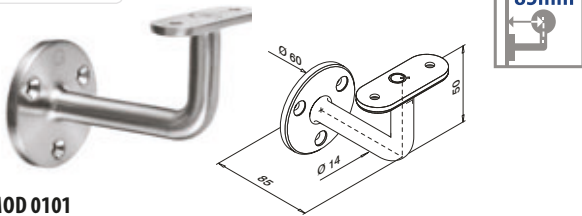
**MOD 0101****304****INDOOR**

13.0101.000.12	QS-7	302	QS-12	303	QS-87	305	2
----------------	------	-----	-------	-----	-------	-----	---

316**OUTDOOR**

14.0101.000.12	QS-50	302	QS-13	303	QS-87	305	2
----------------	-------	-----	-------	-----	-------	-----	---

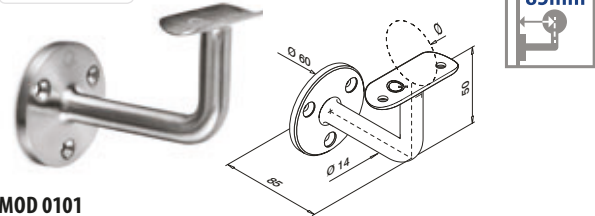

Wall - tube

**MOD 0101****304****INDOOR**

13.0101.042.12	42,4	QS-7	302	QS-10	302	QS-87	305	2
----------------	------	------	-----	-------	-----	-------	-----	---

13.0101.048.12	48,3	QS-7	302	QS-10	302	QS-87	305	2
----------------	------	------	-----	-------	-----	-------	-----	---

316**OUTDOOR**

14.0101.042.12	42,4	QS-50	302	QS-11	302	QS-87	305	2
----------------	------	-------	-----	-------	-----	-------	-----	---

14.0101.048.12	48,3	QS-50	302	QS-11	302	QS-87	305	2
----------------	------	-------	-----	-------	-----	-------	-----	---

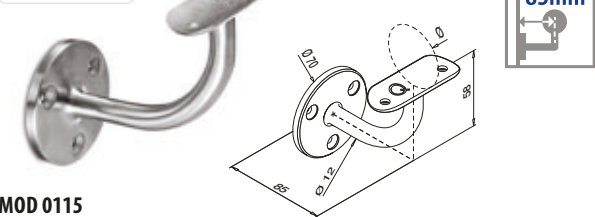

Wall - tube

**MOD 0115****304****INDOOR**

13.0115.042.12	42,4	QS-7	302	QS-10	302	QS-87	305	2
----------------	------	------	-----	-------	-----	-------	-----	---

13.0115.048.12	48,3	QS-7	302	QS-10	302	QS-87	305	2
----------------	------	------	-----	-------	-----	-------	-----	---

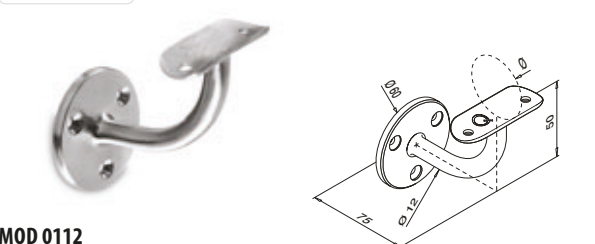

Wall - tube

**MOD 0112****304****INDOOR**

13.0112.033.12	33,7	QS-7	302	QS-10	302	QS-87	305	2
----------------	------	------	-----	-------	-----	-------	-----	---

13.0112.042.12	42,4	QS-7	302	QS-10	302	QS-87	305	2
----------------	------	------	-----	-------	-----	-------	-----	---

13.0112.048.12	48,3	QS-7	302	QS-10	302	QS-87	305	2
----------------	------	------	-----	-------	-----	-------	-----	---

316**OUTDOOR**

14.0112.042.12	42,4	QS-50	302	QS-11	302	QS-87	305	2
----------------	------	-------	-----	-------	-----	-------	-----	---

14.0112.048.12	48,3	QS-50	302	QS-11	302	QS-87	305	2
----------------	------	-------	-----	-------	-----	-------	-----	---

Zinc

Stainless steel effect

INDOOR

10.0112.033.19	33,7	QS-7	302	QS-10	302	QS-87	305	2
----------------	------	------	-----	-------	-----	-------	-----	---

10.0112.042.19	42,4	QS-7	302	QS-10	302	QS-87	305	2
----------------	------	------	-----	-------	-----	-------	-----	---

10.0112.048.19	48,3	QS-7	302	QS-10	302	QS-87	305	2
----------------	------	------	-----	-------	-----	-------	-----	---

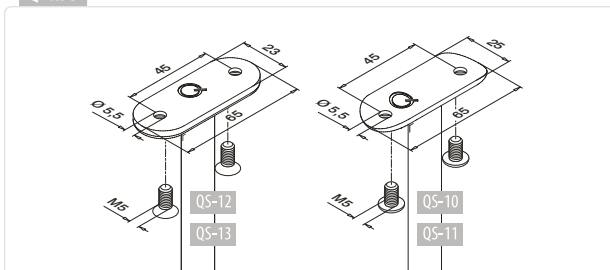
**Q-INFO**

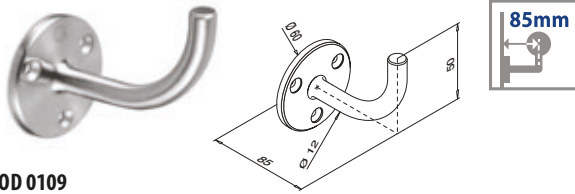
**MOD 0109****304****INDOOR**

13.0109.000.12	QS-7 302	2
----------------	----------	---

316**OUTDOOR**

14.0109.000.12	QS-50 302 / QS-87 305	2
----------------	-----------------------	---

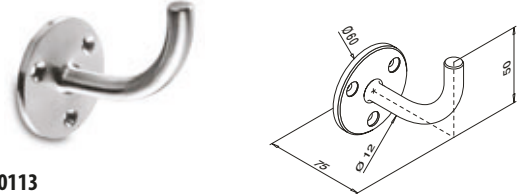
**MOD 0113****304****INDOOR**

13.0113.000.12	QS-7 302	2
----------------	----------	---

316**OUTDOOR**

14.0113.000.12	QS-50 302 / QS-87 305	2
----------------	-----------------------	---

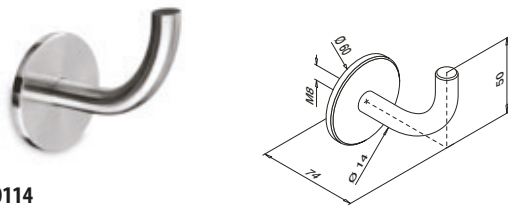
**MOD 0114****304****INDOOR**

13.0114.000.12	QS-1 302	2
----------------	----------	---

316**OUTDOOR**

14.0114.000.12	QS-2 302	2
----------------	----------	---

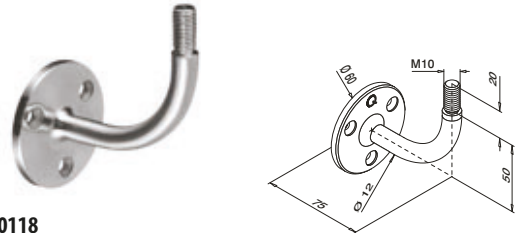
**MOD 0118****304****INDOOR**

13.0118.000.12	QS-7 302 / QS-87 305	2
----------------	----------------------	---

**MOD 0519****Zinc**

Stainless steel effect

INDOOR

10.0519.065.19		2
----------------	--	---

Q-INFO**MOD 0118****Q-INFO****MOD 0519**For MOD 0109,
0118 and 0113

Wall - flat

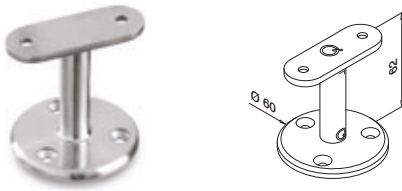
**MOD 0708****304**

INDOOR			
13.0708.000.12	QS-5 302 / QS-12 303		2



Wall - tube

**MOD 0708****304**

INDOOR		Ø		
13.0708.042.12	42,4	QS-5 302 / QS-10 302		2
13.0708.048.12	48,3	QS-5 302 / QS-10 302		2

316

OUTDOOR		Ø		
14.0708.042.12	42,4	QS-6 302 / QS-11 302		2
14.0708.048.12	48,3	QS-6 302 / QS-11 302		2

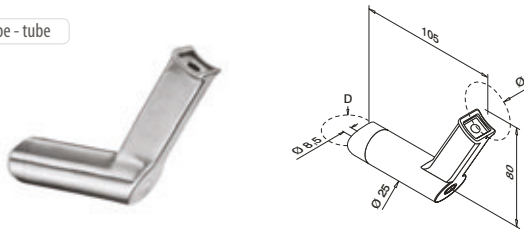

Tube - tube

**MOD 9330** - D = Ø 42,4 mm**304**

INDOOR		D	Ø		
13.9330.042.12	42,4	42,4	QS-21 303 / QS-25 303		2

MOD 9331 - D = Ø 48,3 mm**304**

INDOOR		D	Ø		
13.9331.042.12	48,3	42,4	QS-21 303 / QS-25 303		2
13.9331.048.12	48,3	48,3	QS-21 303 / QS-25 303		2

**MOD 8925, 0900**

Ø 196, 198

Q-INFO

MOD 0708

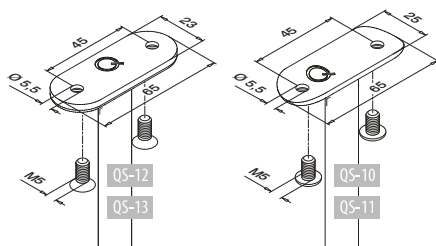

Q-INFO

MOD 9330 / 9331

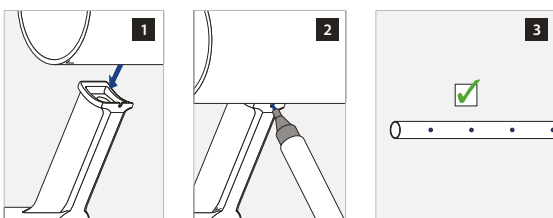

Q-INFO



Q-22

Q-ultra-clean
500 ml
19.0610.000.00

Q-INFO



Q-23

Q-cleaner
300 ml
19.0601.000.00

Flat - flat

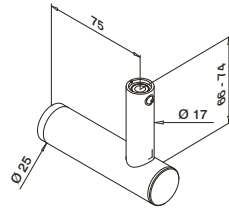

MOD 0147

304

INDOOR

13.0147.000.12	QS-21	303	QS-24	303	2
----------------	-------	-----	-------	-----	---

NEW



International Design Model Protection

Flat - tube

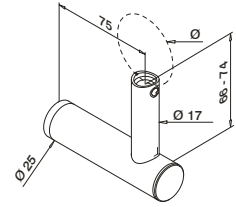

MOD 0147

304

INDOOR

13.0147.044.12	Ø	42,4 / 48,3	QS-21	303	QS-25	303	2
----------------	---	-------------	-------	-----	-------	-----	---

316

OUTDOOR

14.0147.044.12	Ø	42,4 / 48,3	QS-22	303	QS-71	303	2
----------------	---	-------------	-------	-----	-------	-----	---

NEW



International Design Model Protection

Tube - tube

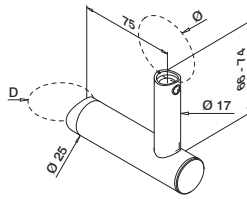

MOD 0143 - D = Ø 42,4 mm

304

INDOOR

13.0143.044.12	D	Ø	42,4 / 48,3	QS-21	303	QS-25	303	2
----------------	---	---	-------------	-------	-----	-------	-----	---

316

OUTDOOR

14.0143.044.12	D	Ø	42,4 / 48,3	QS-22	303	QS-71	303	2
----------------	---	---	-------------	-------	-----	-------	-----	---

MOD 0144 - D = Ø 48,3 mm

304

INDOOR

13.0144.044.12	D	Ø	42,4 / 48,3	QS-21	303	QS-25	303	2
----------------	---	---	-------------	-------	-----	-------	-----	---

316

OUTDOOR

14.0144.044.12	D	Ø	42,4 / 48,3	QS-22	303	QS-71	303	2
----------------	---	---	-------------	-------	-----	-------	-----	---

NEW



International Design Model Protection

Q-INFO MOD 0147.044

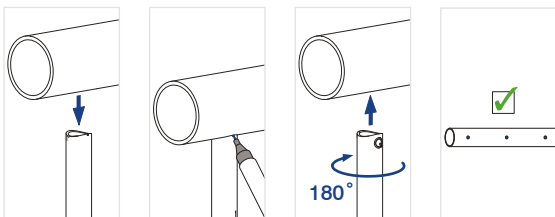

Q-INFO

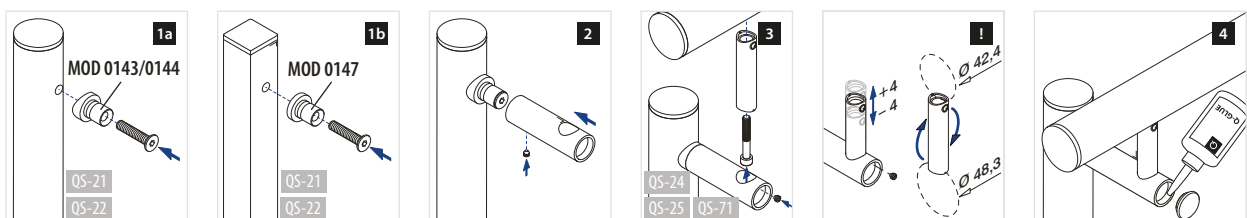

Glass - flat

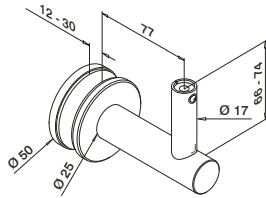

MOD 0148

304

INDOOR

13.0148.000.12



2



International Design Model Protection

Glass - tube

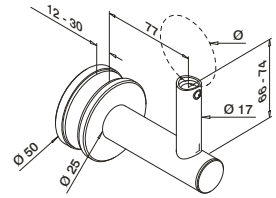

MOD 0148

304

INDOOR

13.0148.044.12

Ø

42,4 / 48,3



2



International Design Model Protection



Q-INFO MOD 0148.044

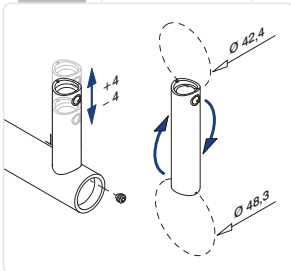

Q-INFO MOD 0148.044

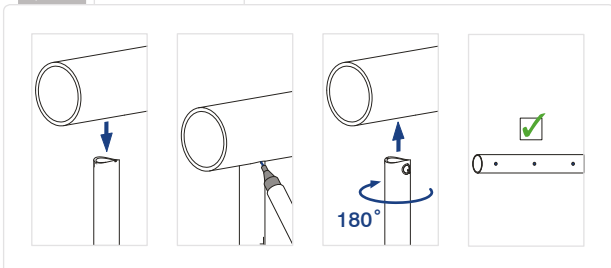

Q-INFO MOD 0148.044

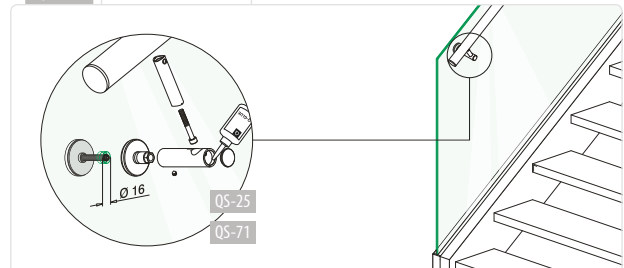

Q-LINE - Handrail brackets

Glass - flat

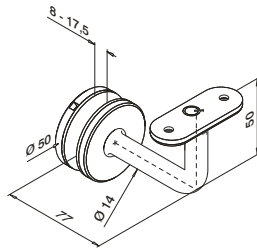

MOD 0117

304

INDOOR			
13.0117.000.12	Ø	QS-12	303
			2

316

OUTDOOR			
14.0117.000.12	Ø	QS-13	303
			2



Glass - tube

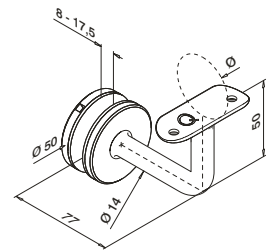

MOD 0117

304

INDOOR			
13.0117.033.12	Ø	QS-10	302
	33,7		2
13.0117.042.12	Ø	QS-10	302
	42,4		2
13.0117.048.12	Ø	QS-10	302
	48,3		2

316

OUTDOOR			
14.0117.042.12	Ø	QS-11	302
	42,4		2
14.0117.048.12	Ø	QS-11	302
	48,3		2



Glass - tube

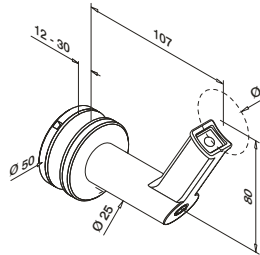

MOD 9350

304

INDOOR			
13.9350.042.12	Ø	QS-25	303
	42,4		2
13.9350.048.12	Ø	QS-25	303
	48,3		2

316

OUTDOOR			
14.9350.042.12	Ø	QS-71	303
	42,4		2
14.9350.048.12	Ø	QS-71	303
	48,3		2



Q-INFO MOD 9350

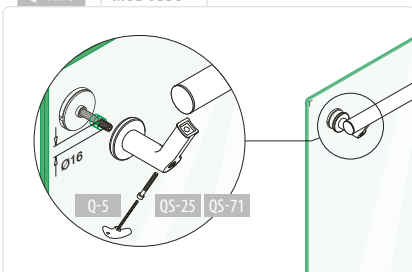

Q-INFO MOD 0117 - Mounting A

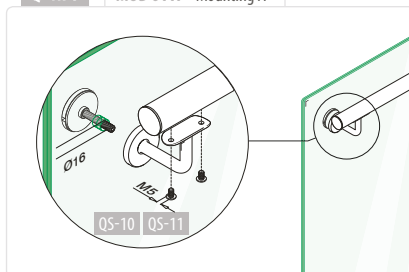

Q-INFO MOD 0117 - Mounting B

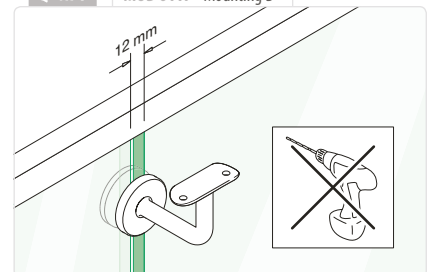

Q-LINE - Handrail brackets

Tube - tube



+55°
-55°

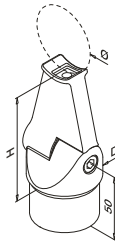

MOD 0715 - D = Ø 42,4 mm

304

INDOOR	D	Ø	H			
13.0715.242.12	Ø 42,4 x 2,0	42,4	79	QS-54	303	2

316

OUTDOOR	D	Ø	H			
14.0715.242.12	Ø 42,4 x 2,0	42,4	79	QS-70	303	2



EXTRA STRONG

MOD 0716 - D = Ø 48,3 mm

304

INDOOR	D	Ø	H			
13.0716.248.12	Ø 48,3 x 2,0	48,3	80	QS-54	303	2 Tested



TESTED 80

EXTRA STRONG

Tube - tube

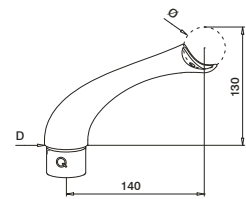

MOD 0706 - D = Ø 42,4 mm

304

INDOOR	D	Ø			
13.0706.242.12	Ø 42,4 x 2,0	42,4	QS-83	302	2

MOD 0707 - D = Ø 48,3 mm

304

INDOOR	D	Ø			
13.0707.248.12	Ø 48,3 x 2,0	48,3	QS-83	302	2



DESIGN product

International Design Model Protection



MOD 8925, 0900

196, 198



MOD 0561

129

Q-INFO

MOD 0715 / 0716

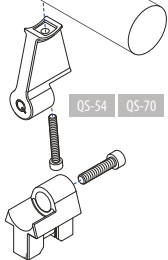

Q-INFO



Q-22

Q-ultra-clean

500 ml

19.0610.000.00

Q-INFO

MOD 0706

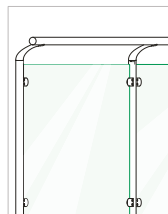
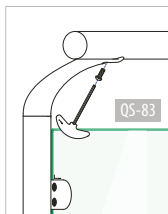
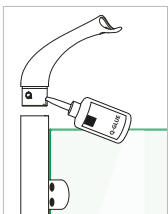

Q-INFO



Q-LINE - Handrail brackets, adjustable

Tube - tube

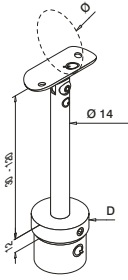
**MOD 0697** - D = Ø 42,4 mm

304				
INDOOR	D	Ø		
13.0697.242.12	Ø 42,4 x 2,0	42,4	QS-10	302 2
316				
OUTDOOR	D	Ø		
14.0697.242.12	Ø 42,4 x 2,0	42,4	QS-11	302 2

MOD 0699 - D = Ø 48,3

304				
INDOOR	D	Ø		
13.0699.248.12	Ø 48,3 x 2,0	48,3	QS-10	302 2
316				
OUTDOOR	D	Ø		
14.0699.248.12	Ø 48,3 x 2,0	48,3	QS-11	302 2

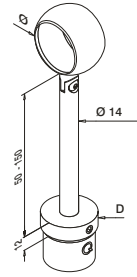

Tube - tube

**MOD 0714** - D = Ø 48,3 / D = Ø 42,4 mm

304				
INDOOR	D	Ø		
13.0714.042.12	Ø 42,4 x 2,6	42,4		2
13.0714.048.12	Ø 48,3 x 2,6	48,3		2



Q-INFO

MOD 0697 / 0699

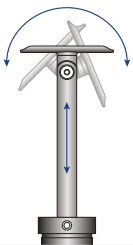

Q-INFO

MOD 0714



Q-INFO



Q-23
Q-cleaner
300 ml
19.0601.000.00

Q-INFO



Q-22
Q-ultra-clean
500 ml
19.0610.000.00

Q-LINE - Handrail brackets

Tube - flat

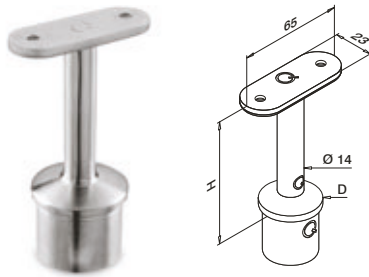
**MOD 0709** - D = Ø 33,7 mm**304**

INDOOR	D	H		
13.0709.200.12	Ø 33,7 x 2,0	80	QS-12	303 2

MOD 0710 - D = Ø 42,4 mm**304**

INDOOR	D	H		
13.0710.200.12	Ø 42,4 x 2,0	81	QS-12	303 2
13.0710.000.12	Ø 42,4 x 2,6	81	QS-12	303 2

316

OUTDOOR	D	H		
14.0710.200.12	Ø 42,4 x 2,0	81	QS-13	303 2
14.0710.000.12	Ø 42,4 x 2,6	81	QS-13	303 2

MOD 0711 - D = Ø 48,3 mm**304**

INDOOR	D	H		
13.0711.200.12	Ø 48,3 x 2,0	82	QS-12	303 2
13.0711.000.12	Ø 48,3 x 2,6	82	QS-12	303 2

316

OUTDOOR	D	H		
14.0711.200.12	Ø 48,3 x 2,0	82	QS-13	303 2
14.0711.000.12	Ø 48,3 x 2,6	82	QS-13	303 2

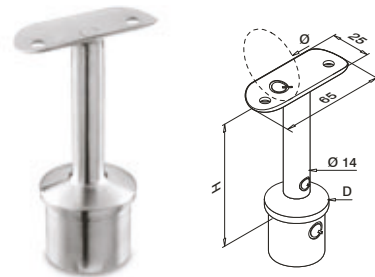

Tube - tube

**MOD 0709** - D = Ø 33,7 mm**304**

INDOOR	D	Ø	H		
13.0709.233.12	Ø 33,7 x 2,0	33,7	78	QS-10	302 2
13.0709.242.12	Ø 33,7 x 2,0	42,4	78	QS-10	302 2

MOD 0710 - D = Ø 42,4 mm**304**

INDOOR	D	Ø	H		
13.0710.242.12	Ø 42,4 x 2,0	42,4	79	QS-10	302 2
13.0710.248.12	Ø 42,4 x 2,0	48,3	79	QS-10	302 2
13.0710.042.12	Ø 42,4 x 2,6	42,4	79	QS-10	302 2
13.0710.048.12	Ø 42,4 x 2,6	48,3	79	QS-10	302 2

316

OUTDOOR	D	Ø	H		
14.0710.242.12	Ø 42,4 x 2,0	42,4	79	QS-11	302 2
14.0710.248.12	Ø 42,4 x 2,0	48,3	79	QS-11	302 2
14.0710.042.12	Ø 42,4 x 2,6	42,4	79	QS-11	302 2
14.0710.048.12	Ø 42,4 x 2,6	48,3	79	QS-11	302 2

MOD 0711 - D = Ø 48,3 mm**304**

INDOOR	D	Ø	H		
13.0711.248.12	Ø 48,3 x 2,0	48,3	80	QS-10	302 2 Tested
13.0711.042.12	Ø 48,3 x 2,6	42,4	80	QS-10	302 2
13.0711.048.12	Ø 48,3 x 2,6	48,3	80	QS-10	302 2

316

OUTDOOR	D	Ø	H		
14.0711.248.12	Ø 48,3 x 2,0	48,3	80	QS-11	302 2
14.0711.042.12	Ø 48,3 x 2,6	42,4	80	QS-11	302 2
14.0711.048.12	Ø 48,3 x 2,6	48,3	80	QS-11	302 2



Q-INFO

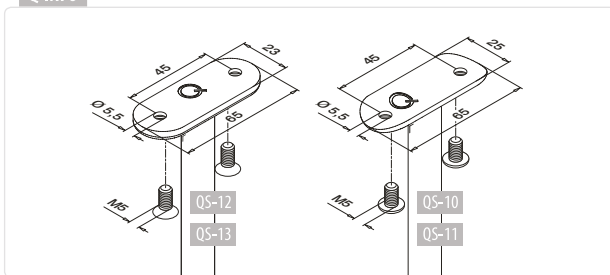

Q-INFO



Q-21
Q-glue
50 ml
19.1331.000.00



Q-glue space



Tube - tube

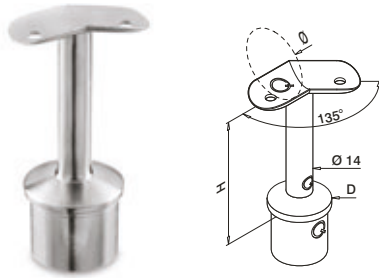

MOD 0709 - D = Ø 33,7 mm

304						
INDOOR	D	Ø	H			
13.0709.333.12	Ø 33,7 x 2,0	33,7	78	QS-10	302	2
13.0709.342.12	Ø 33,7 x 2,0	42,4	78	QS-10	302	2

MOD 0710 - D = Ø 42,4 mm

304						
INDOOR	D	Ø	H			
13.0710.342.12	Ø 42,4 x 2,0	42,4	79	QS-10	302	2
13.0710.348.12	Ø 42,4 x 2,0	48,3	79	QS-10	302	2
13.0710.442.12	Ø 42,4 x 2,6	42,4	79	QS-10	302	2
13.0710.448.12	Ø 42,4 x 2,6	48,3	79	QS-10	302	2

316						
OUTDOOR	D	Ø	H			
14.0710.342.12	Ø 42,4 x 2,0	42,4	79	QS-11	302	2
14.0710.348.12	Ø 42,4 x 2,0	48,3	79	QS-11	302	2
14.0710.442.12	Ø 42,4 x 2,6	42,4	79	QS-11	302	2
14.0710.448.12	Ø 42,4 x 2,6	48,3	79	QS-11	302	2

MOD 0711 - D = Ø 48,3 mm

304						
INDOOR	D	Ø	H			
13.0711.348.12	Ø 48,3 x 2,0	48,3	80	QS-10	302	2
13.0711.442.12	Ø 48,3 x 2,6	42,4	80	QS-10	302	2
13.0711.448.12	Ø 48,3 x 2,6	48,3	80	QS-10	302	2

316						
OUTDOOR	D	Ø	H			
14.0711.348.12	Ø 48,3 x 2,0	48,3	80	QS-11	302	2
14.0711.442.12	Ø 48,3 x 2,6	42,4	80	QS-11	302	2
14.0711.448.12	Ø 48,3 x 2,6	48,3	80	QS-11	302	2



Tube - tube

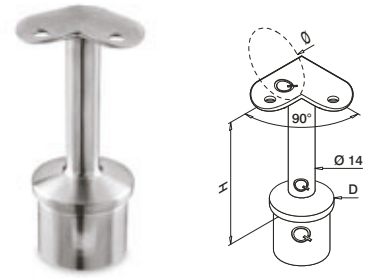

MOD 0709 - D = Ø 33,7 mm

304						
INDOOR	D	Ø	H			
13.0709.833.12	Ø 33,7 x 2,0	33,7	78	QS-10	302	2
13.0709.842.12	Ø 33,7 x 2,0	42,4	78	QS-10	302	2

MOD 0710 - D = Ø 42,4 mm

304						
INDOOR	D	Ø	H			
13.0710.842.12	Ø 42,4 x 2,0	42,4	79	QS-10	302	2
13.0710.848.12	Ø 42,4 x 2,0	48,3	79	QS-10	302	2
13.0710.942.12	Ø 42,4 x 2,6	42,4	79	QS-10	302	2
13.0710.948.12	Ø 42,4 x 2,6	48,3	79	QS-10	302	2

316						
OUTDOOR	D	Ø	H			
14.0710.842.12	Ø 42,4 x 2,0	42,4	79	QS-11	302	2
14.0710.848.12	Ø 42,4 x 2,0	48,3	79	QS-11	302	2
14.0710.942.12	Ø 42,4 x 2,6	42,4	79	QS-11	302	2
14.0710.948.12	Ø 42,4 x 2,6	48,3	79	QS-11	302	2

MOD 0711 - D = Ø 48,3 mm

304						
INDOOR	D	H	Ø			
13.0711.848.12	Ø 48,3 x 2,0	80	48,3	QS-10	302	2
13.0711.942.12	Ø 48,3 x 2,6	80	42,4	QS-10	302	2
13.0711.948.12	Ø 48,3 x 2,6	80	48,3	QS-10	302	2

316						
OUTDOOR	D	H	Ø			
14.0711.848.12	Ø 48,3 x 2,0	80	48,3	QS-11	302	2
14.0711.942.12	Ø 48,3 x 2,6	80	42,4	QS-11	302	2
14.0711.948.12	Ø 48,3 x 2,6	80	48,3	QS-11	302	2



Q-INFO

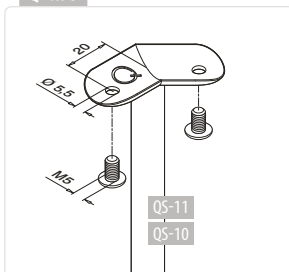

Q-INFO

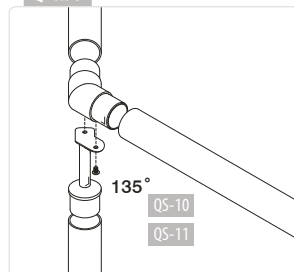

Q-INFO

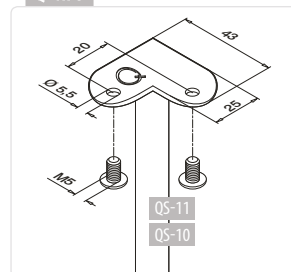

Q-INFO

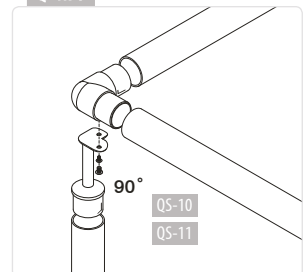

Q-LINE - Handrail brackets, adjustable

Tube - flat

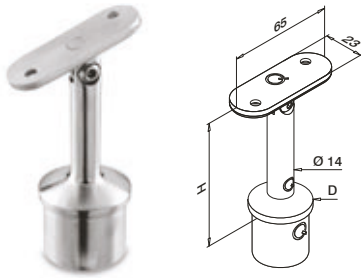

MOD 0717 - D = Ø 33,7 mm

304

INDOOR	D	H	Q5-12	Q303	
13.0717.200.12	Ø 33,7 x 2,0	80	Q5-12	Q303	2

MOD 0718 - D = Ø 42,4 mm

304

INDOOR	D	H	Q5-12	Q303	
13.0718.200.12	Ø 42,4 x 2,0	81	Q5-12	Q303	2
13.0718.000.12	Ø 42,4 x 2,6	81	Q5-12	Q303	2

316

OUTDOOR	D	H	Q5-13	Q303	
14.0718.200.12	Ø 42,4 x 2,0	81	Q5-13	Q303	2
14.0718.000.12	Ø 42,4 x 2,6	81	Q5-13	Q303	2



Tube - tube

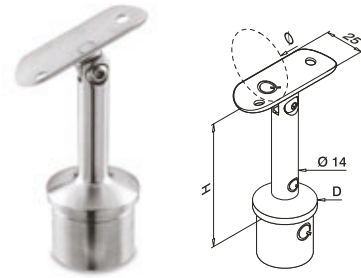

MOD 0717 - D = Ø 33,7 mm

304

INDOOR	D	Ø	H	Q5-10	Q302	
13.0717.233.12	Ø 33,7 x 2,0	33,7	78	Q5-10	Q302	2
13.0717.242.12	Ø 33,7 x 2,0	42,4	78	Q5-10	Q302	2

MOD 0718 - D = Ø 42,4 mm

304

INDOOR	D	Ø	H	Q5-10	Q302	
13.0718.242.12	Ø 42,4 x 2,0	42,4	79	Q5-10	Q302	2
13.0718.248.12	Ø 42,4 x 2,0	48,3	79	Q5-10	Q302	2
13.0718.042.12	Ø 42,4 x 2,6	42,4	79	Q5-10	Q302	2
13.0718.048.12	Ø 42,4 x 2,6	48,3	79	Q5-10	Q302	2

316

OUTDOOR	D	Ø	H	Q5-11	Q302	
14.0718.242.12	Ø 42,4 x 2,0	42,4	79	Q5-11	Q302	2
14.0718.248.12	Ø 42,4 x 2,0	48,3	79	Q5-11	Q302	2
14.0718.042.12	Ø 42,4 x 2,6	42,4	79	Q5-11	Q302	2
14.0718.048.12	Ø 42,4 x 2,6	48,3	79	Q5-11	Q302	2

MOD 0719 - D = Ø 48,3 mm

304

INDOOR	D	Ø	H	Q5-10	Q302	
13.0719.248.12	Ø 48,3 x 2,0	48,3	80	Q5-10	Q302	2
13.0719.042.12	Ø 48,3 x 2,6	42,4	80	Q5-10	Q302	2
13.0719.048.12	Ø 48,3 x 2,6	48,3	80	Q5-10	Q302	2

316

OUTDOOR	D	Ø	H	Q5-11	Q302	
14.0719.248.12	Ø 48,3 x 2,0	48,3	80	Q5-11	Q302	2
14.0719.042.12	Ø 48,3 x 2,6	42,4	80	Q5-11	Q302	2
14.0719.048.12	Ø 48,3 x 2,6	48,3	80	Q5-11	Q302	2



Q-INFO

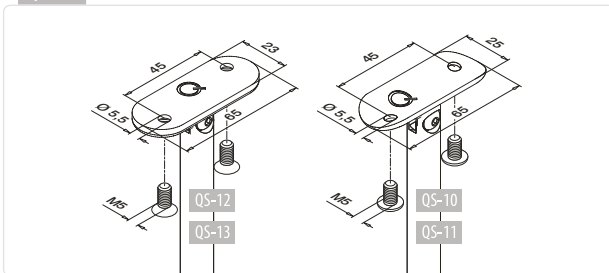

Q-INFO



Q-21
Q-glue
50 ml
19.1331.000.00



Q-glue space



Q-INFO



Q-22
Q-ultra-clean
500 ml
19.0610.000.00

Handrails

SATIN

Q-LINE - Handrail brackets

Tube - tube

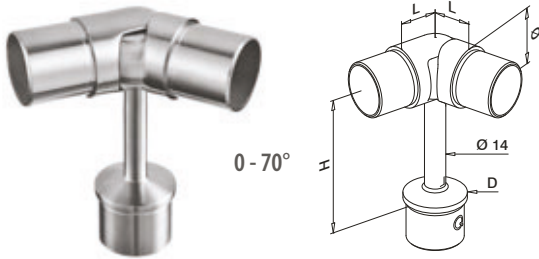

MOD 0736 - D = Ø 42,4 mm

304					
INDOOR	D	Ø	L	H	
13.0736.242.12	Ø 42,4 x 2,0	Ø 42,4 x 2,0	27	100	2

316					
OUTDOOR	D	Ø	L	H	
14.0736.242.12	Ø 42,4 x 2,0	Ø 42,4 x 2,0	27	100	2

MOD 0737 - D = Ø 48,3 mm

304					
INDOOR	D	Ø	L	H	
13.0737.248.12	Ø 48,3 x 2,0	Ø 48,3 x 2,0	30	100	2

316					
OUTDOOR	D	Ø	L	H	
14.0737.248.12	Ø 48,3 x 2,0	Ø 48,3 x 2,0	30	100	2



Handrails

SATIN

Q-LINE - Handrail adapters

Tube - flat

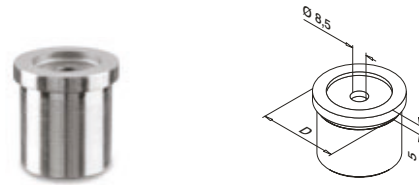

MOD 0728 - D = Ø 33,7 mm

304				
INDOOR	D			
13.0728.200.12	Ø 33,7 x 2,0	QS-26	303	2

MOD 0727 - D = Ø 42,4 mm

304				
INDOOR	D			
13.0727.200.12	Ø 42,4 x 2,0	QS-26	303	2
13.0727.000.12	Ø 42,4 x 2,6	QS-26	303	2

316				
OUTDOOR	D			
14.0727.200.12	Ø 42,4 x 2,0	QS-27	303	2
14.0727.000.12	Ø 42,4 x 2,6	QS-27	303	2

MOD 0726 - D = Ø 48,3 mm

304				
INDOOR	D			
13.0726.200.12	Ø 48,3 x 2,0	QS-26	303	2
13.0726.000.12	Ø 48,3 x 2,6	QS-26	303	2

316				
OUTDOOR	D			
14.0726.200.12	Ø 48,3 x 2,0	QS-27	303	2

MOD 0725 - D = Ø 60,3 mm

304				
INDOOR	D			
13.0725.000.12	Ø 60,3 x 2,0	QS-26	303	2



Tube - tube

Height 5 mm

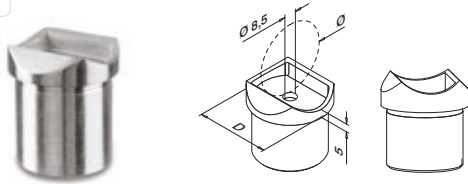
**MOD 0728** - D = Ø 33,7 mm**304**

INDOOR	D	Ø			
13.0728.242.12	Ø 33,7 x 2,0	42,4	QS-26	303	2
13.0728.248.12	Ø 33,7 x 2,0	48,3	QS-26	303	2

MOD 0727 - D = Ø 42,4 mm**304**

INDOOR	D	Ø			
13.0727.248.12	Ø 42,4 x 2,0	48,3	QS-26	303	2
13.0727.048.12	Ø 42,4 x 2,6	48,3	QS-26	303	2

316

OUTDOOR	D	Ø			
14.0727.248.12	Ø 42,4 x 2,0	48,3	QS-27	303	2

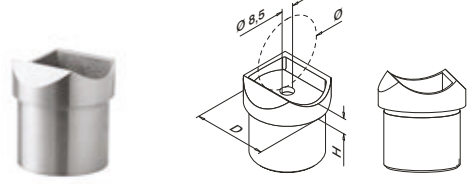

Tube - tube

**MOD 0773** - D = Ø 33,7 mm**304**

INDOOR	D	Ø	H		
13.0773.233.12	Ø 33,7 x 2,0	33,7	8	QS-26	303
					2

Tube - tube

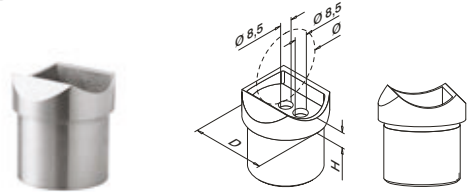
**MOD 0772** - D = Ø 42,4 mm**304**

INDOOR	D	Ø	H		
13.0772.242.12	Ø 42,4 x 2,0	42,4	9	QS-26	303
13.0772.042.12	Ø 42,4 x 2,6	42,4	9	QS-26	303

316

OUTDOOR	D	Ø	H		
14.0772.242.12	Ø 42,4 x 2,0	42,4	9	QS-27	303
14.0772.042.12	Ø 42,4 x 2,6	42,4	9	QS-27	303

MOD 0771 - D = Ø 48,3 mm**304**

INDOOR	D	Ø	H		
13.0771.248.12	Ø 48,3 x 2,0	48,3	11	QS-26	303
13.0771.048.12	Ø 48,3 x 2,6	48,3	11	QS-26	303

316

OUTDOOR	D	Ø	H		
14.0771.248.12	Ø 48,3 x 2,0	48,3	11	QS-27	303
14.0771.048.12	Ø 48,3 x 2,6	48,3	11	QS-27	303



Q-INFO

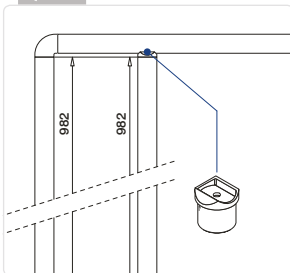

Q-21

Q-glue

50 ml

19.1331.000.00

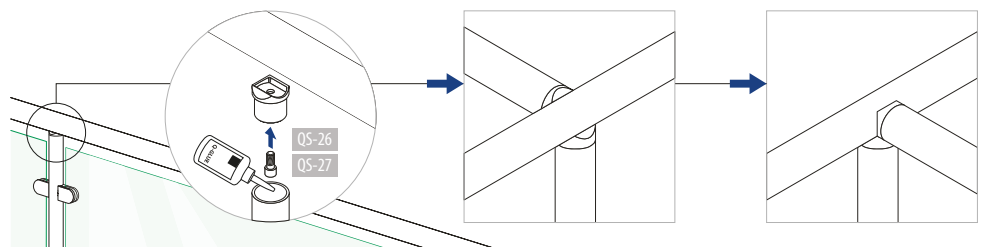

Tube - flat

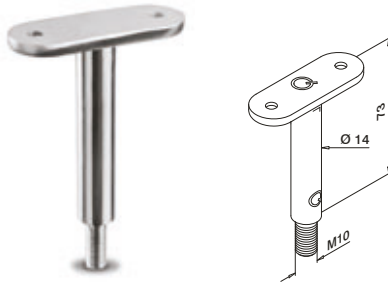

MOD 0810

304

INDOOR			
13.0810.000.12	QS-12	303	2

316

OUTDOOR			
14.0810.000.12	QS-13	303	2



Tube - tube

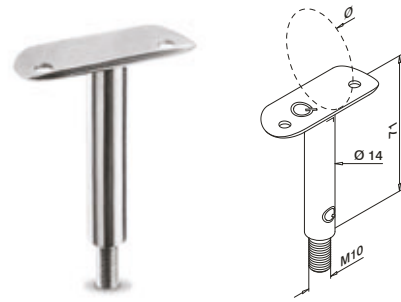

MOD 0810

304

INDOOR				
13.0810.033.12	Ø	QS-10	302	2
13.0810.042.12	42,4	QS-10	302	2
13.0810.048.12	48,3	QS-10	302	2

316

OUTDOOR				
14.0810.042.12	42,4	QS-11	302	2
14.0810.048.12	48,3	QS-11	302	2



Tube - tube

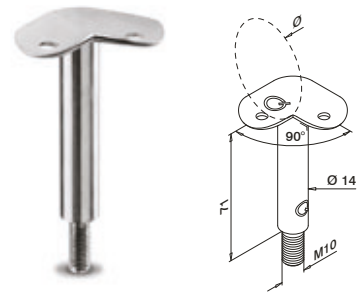

MOD 0810

304

INDOOR				
13.0810.942.12	42,4	QS-10	302	2
13.0810.948.12	48,3	QS-10	302	2

316

OUTDOOR				
14.0810.942.12	42,4	QS-11	302	2
14.0810.948.12	48,3	QS-11	302	2



Q-INFO

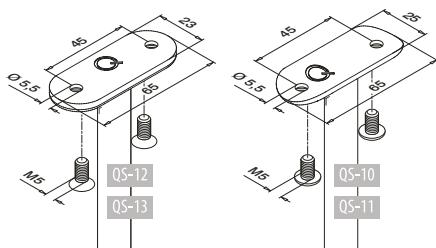

Q-INFO

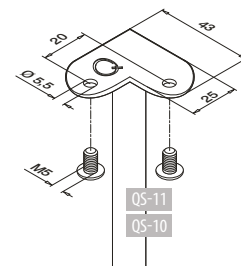

Q-INFO



Q-23

Q-cleaner

300 ml

19.0601.000.00

Q-LINE - Handrail brackets, adjustable

Tube - flat

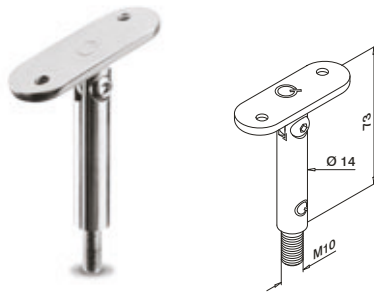

MOD 0818

304

INDOOR

13.0818.000.12	QS-12 303	2
----------------	------------	---



Tube - tube

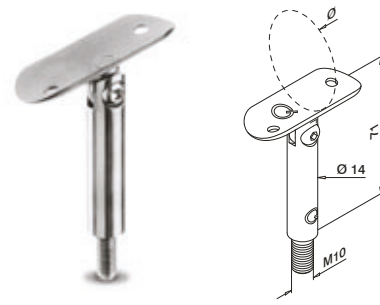

MOD 0818

304

INDOOR

13.0818.033.12	Ø 33,7	QS-10 302	2
13.0818.042.12	Ø 42,4	QS-10 302	2
13.0818.048.12	Ø 48,3	QS-10 302	2

316

OUTDOOR

14.0818.042.12	Ø 42,4	QS-11 302	2
14.0818.048.12	Ø 48,3	QS-11 302	2



Q-INFO

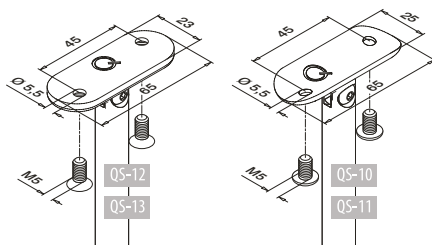

Q-INFO



Q-23
Q-cleaner
300 ml
19.0601.000.00

Q-INFO

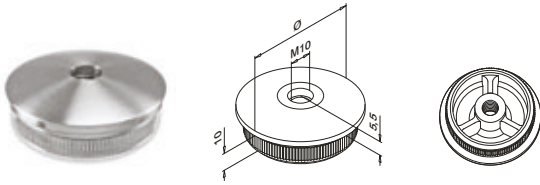

Q-22
Q-ultra-clean
500 ml
19.0610.000.00

**MOD 5735 - EASY HIT®**

304		
INDOOR	Ø	
13.5735.242.12	42,4 x 2,0	2
13.5735.042.12	42,4 x 2,6	2
13.5735.248.12	48,3 x 2,0	2
13.5735.048.12	48,3 x 2,6	2
316		
OUTDOOR	Ø	
14.5735.242.12	42,4 x 2,0	2
14.5735.042.12	42,4 x 2,6	2
14.5735.248.12	48,3 x 2,0	2
14.5735.048.12	48,3 x 2,6	2
14.5735.060.12	60,3 x 2,0	2

**MOD 0811**

304		
INDOOR		
13.0811.068.12	QS-48 303	2
316		
OUTDOOR		
14.0811.068.12	QS-89 303	2

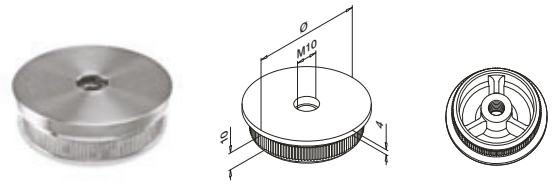
**MOD 5736 - EASY HIT®**

304		
INDOOR	Ø	
13.5736.242.12	42,4 x 2,0	2
13.5736.042.12	42,4 x 2,6	2
13.5736.248.12	48,3 x 2,0	2
13.5736.048.12	48,3 x 2,6	2
316		
OUTDOOR	Ø	
14.5736.242.12	42,4 x 2,0	2
14.5736.248.12	48,3 x 2,0	2

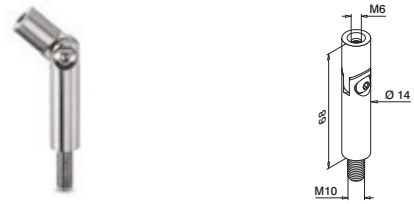
**MOD 0812**

304		
INDOOR		
13.0812.068.12	QS-48 303	2
316		
OUTDOOR		
14.0812.068.12	QS-89 303	2

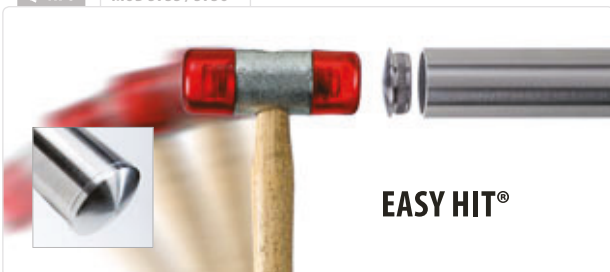
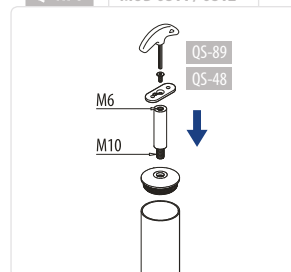
**Q-INFO MOD 5735 / 5736****Q-INFO MOD 0811 / 0812**

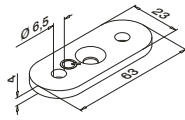
**MOD 1800****304**

INDOOR			
13.1800.000.12	QS-48 303 / QS-12 303		8

316

OUTDOOR			
14.1800.000.12	QS-89 303 / QS-13 303		8

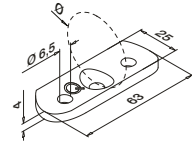
**MOD 1800****304**

INDOOR		Ø		
13.1800.033.12	33,7	QS-48 303 / QS-10 302		8
13.1800.042.12	42,4	QS-48 303 / QS-10 302		8
13.1800.048.12	48,3	QS-48 303 / QS-10 302		8

316

OUTDOOR		Ø		
14.1800.042.12	42,4	QS-89 303 / QS-11 302		8
14.1800.048.12	48,3	QS-89 303 / QS-11 302		8

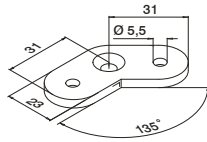
**MOD 1801****304**

INDOOR			
13.1801.000.12	QS-48 303 / QS-12 303		8

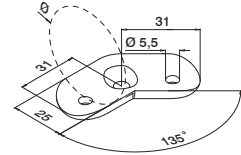
**MOD 1801****304**

INDOOR		Ø		
13.1801.042.12	42,4	QS-48 303 / QS-10 302		8
13.1801.048.12	48,3	QS-48 303 / QS-10 302		8

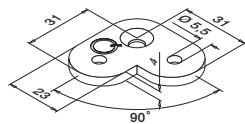
**MOD 1802****304**

INDOOR			
13.1802.000.12	QS-48 303 / QS-12 303		8

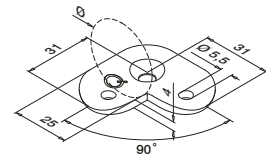
**MOD 1802****304**

INDOOR		Ø		
13.1802.042.12	42,4	QS-48 303 / QS-10 302		8
13.1802.048.12	48,3	QS-48 303 / QS-10 302		8

**MOD 0811**

194

**MOD 0812**

194

**MOD 5735, 5736**

194

**MOD 4811**

114

**MOD 4733**

114

**MOD 1930**

230

**MOD 1935**

230

**MOD 1936**

230

**MOD 0813, 0814, 0815, 0816**

231

Q-INFO

All products on this page will be delivered with satin surfaces and machined sides and edges.

Q-INFO**Q-23**

Q-cleaner

300 ml

19.0601.000.00

Q-INFO**Q-22**

Q-ultra-clean

500 ml

19.0610.000.00

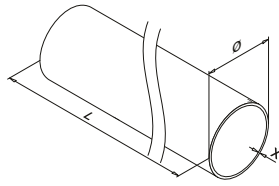
**MOD 8925 / 0900**

Ø 48,3 mm

Steel

INDOOR	Ø	X	
12.8925.248.12	48,3	2,0	L = 2500 mm
12.0900.248.12	48,3	2,0	L = 5000 mm

**Q-INFO****MOD 12.8925 / 0900**

Indoor structures (no wet spaces)

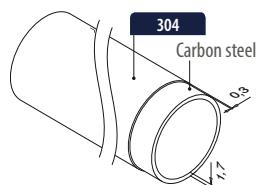



Q-TUBE:

LOWEST TOLERANCE ON TUBE

Q-TUBE

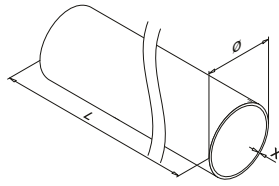
**MOD 8925 / 0900**

Ø 33,7 mm

304

INDOOR	X	
13.8925.233.12	2,0	L = 2500 mm
13.0900.233.12	2,0	L = 5000 mm

Ø 38 mm

316

OUTDOOR	X	
14.8930.138.12	1,5	L = 3000 mm

Ø 42,4 mm

304

INDOOR	X	
13.8925.142.12	1,5	L = 2500 mm
13.0900.142.12	1,5	L = 5000 mm
13.8925.242.12	2,0	L = 2500 mm
13.0900.242.12	2,0	L = 5000 mm
13.8925.042.12	2,6	L = 2500 mm
13.0900.042.12	2,6	L = 5000 mm

316

OUTDOOR	X	
14.0900.142.12	1,5	L = 5000 mm
14.8925.242.12	2,0	L = 2500 mm
14.0900.242.12	2,0	L = 5000 mm
14.8925.042.12	2,6	L = 2500 mm
14.0900.042.12	2,6	L = 5000 mm

Ø 48,3 mm

304

INDOOR	X	
13.8925.248.12	2,0	L = 2500 mm
13.0900.248.12	2,0	L = 5000 mm
13.8925.048.12	2,6	L = 2500 mm
13.0900.048.12	2,6	L = 5000 mm

316

OUTDOOR	X	
14.8925.248.12	2,0	L = 2500 mm
14.0900.248.12	2,0	L = 5000 mm
14.8925.048.12	2,6	L = 2500 mm
14.0900.048.12	2,6	L = 5000 mm

Ø 60,3 mm

304

INDOOR	X	
13.8925.060.12	2,0	L = 2500 mm
13.0900.060.12	2,0	L = 5000 mm



Wooden handrails: see page 241 - 246.

If you have a specific requirement for pre-assembled products please use our order forms on pages 324 - 336.

**Q-LIGHTS**

234, 235

Q-INFO**Save time and money with Q-tube.**

Q-tube has a far tighter tolerance than a standard commercial tube. Even the welding seam of Q-tube has been specially adapted to our fittings. Therefore the tube fits perfectly in conjunction with our fittings, in order for you to be able to work fast and effectively. To prevent damage, and to guarantee the quality, each tube section is separately packaged.

Q-INFO MOD 8925 / 0900

Calculation basis for tubes

	Ø (mm)	A (cm ²)	I _x =I _y (cm ⁴)	W _x =W _y (cm ³)	M (kg/m)	R _{p0,2} (kN/cm ²)	R _m (kN/cm ²)
13.0900.233.12 13.8925.233.12	33,7 x 2,0	1,99	2,51	1,49	1,56	23	54
14.8930.138.12	38,0 x 1,5	1,72	2,87	1,51	1,35	24	53
13.0900.142.12 13.8925.142.12	42,4 x 1,5	1,93	4,64	1,90	1,52	23	54
14.0900.142.12	42,4 x 1,5	1,93	4,64	1,90	1,52	24	53
13.0900.242.12 13.8925.242.12	42,4 x 2,0	2,53	5,19	2,44	1,98	23	54
14.0900.242.12 14.8925.242.12	42,4 x 2,0	2,53	5,19	2,44	1,98	24	53
13.0900.042.12 13.8925.042.12	42,4 x 2,6	3,25	6,46	3,04	2,55	23	54
14.0900.042.12 14.8925.042.12	42,4 x 2,6	3,25	6,46	3,04	2,55	24	53
13.0900.248.12 13.8925.248.12	48,3 x 2,0	2,90	7,80	3,23	2,28	23	54
14.0900.248.12 14.8925.248.12	48,3 x 2,0	2,90	7,80	3,23	2,28	24	53
13.0900.048.12 13.8925.048.12	48,3 x 2,6	3,73	9,78	4,04	2,93	23	54
14.0900.048.12 14.8925.048.12	48,3 x 2,6	3,73	9,78	4,04	2,93	24	53
13.0900.060.12 13.8925.060.12	60,3 x 2,0	3,66	15,58	5,17	2,87	23	54

A = cross sectional area
I_x / I_y = second moment of area
W_x / W_y = section modulus

M = weight
R_{p0,2} = permissible stress
R_m = minimum tensile strength

Q-LINE - Tubular bends



90°

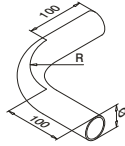

MOD 0903

304

INDOOR	∅	R	
13.0903.242.12	42,4 x 2,0	85	1
13.0903.248.12	48,3 x 2,0	97	1

316

OUTDOOR	∅	R	
14.0903.242.12	42,4 x 2,0	85	1



180°

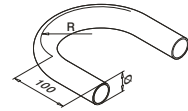

MOD 0906

304

INDOOR	∅	R	
13.0906.242.12	42,4 x 2,0	85	1
13.0906.248.12	48,3 x 2,0	97	1

316

OUTDOOR	∅	R	
14.0906.242.12	42,4 x 2,0	85	1

Q-LINE - Tube brackets

Flat - tube

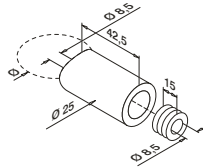

MOD 0625

304

INDOOR	∅		
13.0625.033.12	33,7	QS-3 302 / QS-29 303	4
13.0625.042.12	42,4	QS-3 302 / QS-29 303	4
13.0625.048.12	48,3	QS-3 302 / QS-29 303	4

316

OUTDOOR	∅		
14.0625.042.12	42,4	QS-4 302 / QS-30 303	4
14.0625.048.12	48,3	QS-4 302 / QS-30 303	4



Tube - tube

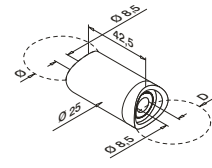

MOD 0627

304

INDOOR	∅	D		
13.0627.042.12	42,4	∅ 42,4	QS-29 303	4



Q-INFO

MOD 0625

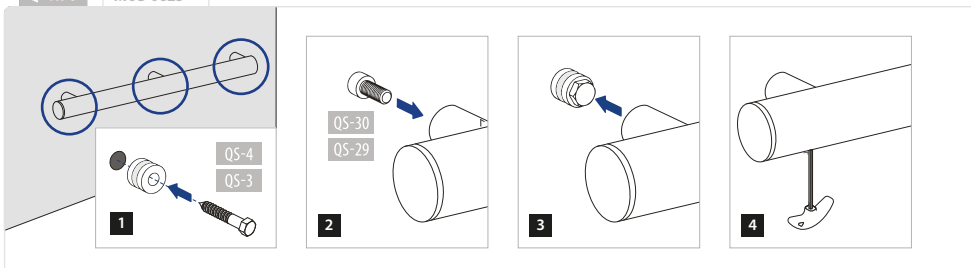

Q-INFO

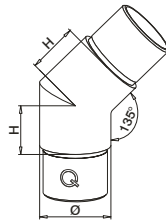

Q-23
Q-cleaner
300 ml
19.0601.000.00

**MOD 0300****304**

INDOOR	Ø	H	
13.0300.233.12	33,7 x 2,0	25	2
13.0300.242.12	42,4 x 2,0	30	2
13.0300.042.12	42,4 x 2,6	30	2
13.0300.248.12	48,3 x 2,0	35	2
13.0300.048.12	48,3 x 2,6	35	2

316

OUTDOOR	Ø	H	
14.0300.242.12	42,4 x 2,0	30	2
14.0300.042.12	42,4 x 2,6	30	2
14.0300.248.12	48,3 x 2,0	35	2
14.0300.048.12	48,3 x 2,6	35	2

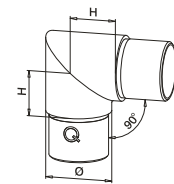
**MOD 0301****304**

INDOOR	Ø	H	
13.0301.233.12	33,7 x 2,0	25	2
13.0301.242.12	42,4 x 2,0	30	2
13.0301.042.12	42,4 x 2,6	30	2
13.0301.248.12	48,3 x 2,0	35	2
13.0301.048.12	48,3 x 2,6	35	2

316

OUTDOOR	Ø	H	
14.0301.242.12	42,4 x 2,0	30	2
14.0301.042.12	42,4 x 2,6	30	2
14.0301.248.12	48,3 x 2,0	35	2
14.0301.048.12	48,3 x 2,6	35	2

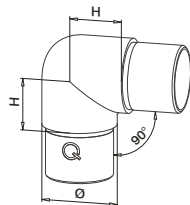

Not suitable with MOD 0710 and 0810 (handrail brackets)

**MOD 0303****304**

INDOOR	Ø	H	
13.0303.233.12	33,7 x 2,0	25	2
13.0303.142.12	42,4 x 1,5	30	2
13.0303.242.12	42,4 x 2,0	30	2
13.0303.042.12	42,4 x 2,6	30	2
13.0303.248.12	48,3 x 2,0	35	2
13.0303.048.12	48,3 x 2,6	35	2
13.0303.060.12	60,3 x 2,0	40	2

316

OUTDOOR	Ø	H	
14.0303.242.12	42,4 x 2,0	30	2
14.0303.042.12	42,4 x 2,6	30	2
14.0303.248.12	48,3 x 2,0	35	2
14.0303.048.12	48,3 x 2,6	35	2

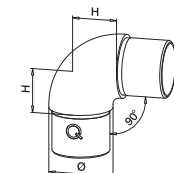

Suitable with MOD 0710 and 0810 (handrail brackets)

**MOD 0305****304**

INDOOR	Ø	H	
13.0305.233.12	33,7 x 2,0	25	2
13.0305.242.12	42,4 x 2,0	30	2
13.0305.248.12	48,3 x 2,0	35	2

316

OUTDOOR	Ø	H	
14.0305.042.12	42,4 x 2,6	30	2
14.0305.242.12	42,4 x 2,0	30	2
14.0305.048.12	48,3 x 2,6	35	2
14.0305.248.12	48,3 x 2,0	35	2

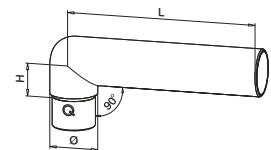

Not suitable with MOD 0710 and 0810 (handrail brackets)

**MOD 0306****304**

INDOOR	Ø	H	L	
13.0306.233.12	33,7 x 2,0	25	223	2
13.0306.242.12	42,4 x 2,0	30	228	2
13.0306.248.12	48,3 x 2,0	35	233	2



Combine with connector MOD 5792 202

Q-INFO

MOD 0306

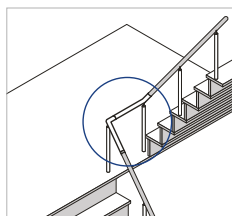

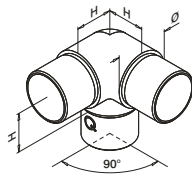

MOD 0304

304

INDOOR	Ø	H	
13.0304.233.12	33,7 x 2,0	25	2
13.0304.242.12	42,4 x 2,0	30	2
13.0304.042.12	42,4 x 2,6	30	2
13.0304.248.12	48,3 x 2,0	35	2
13.0304.048.12	48,3 x 2,6	35	2

316

OUTDOOR	Ø	H	
14.0304.242.12	42,4 x 2,0	30	2
14.0304.042.12	42,4 x 2,6	30	2
14.0304.248.12	48,3 x 2,0	35	2
14.0304.048.12	48,3 x 2,6	35	2

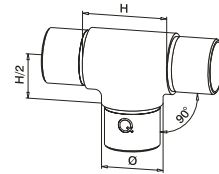

MOD 0307

304

INDOOR	Ø	H	
13.0307.233.12	33,7 x 2,0	50	2
13.0307.242.12	42,4 x 2,0	60	2
13.0307.042.12	42,4 x 2,6	60	2
13.0307.248.12	48,3 x 2,0	70	2
13.0307.048.12	48,3 x 2,6	70	2

316

OUTDOOR	Ø	H	
14.0307.242.12	42,4 x 2,0	60	2
14.0307.042.12	42,4 x 2,6	60	2
14.0307.248.12	48,3 x 2,0	70	2
14.0307.048.12	48,3 x 2,6	70	2

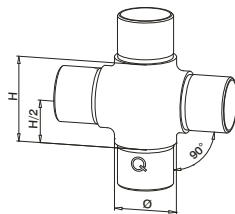

MOD 0309

304

INDOOR	Ø	H	H/2	
13.0309.242.12	42,4 x 2,0	60	30	2
13.0309.248.12	48,3 x 2,0	70	35	2

316

OUTDOOR	Ø	H	H/2	
14.0309.242.12	42,4 x 2,0	60	30	2
14.0309.248.12	48,3 x 2,0	70	35	2



Q-INFO



Q-21
Q-glue
50 ml

19.1331.000.00



Consumption per bonding approx. 1 ml

Q-Video  www.q-railing.com

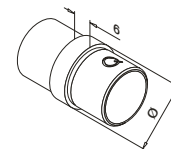
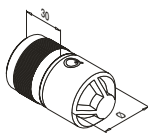
**MOD 5792 - EASY HIT®****304**

Raw

INDOOR

Ø



NEW	13.5792.233.00	for 33,7 x 2,0	2
	13.5792.242.00	for 42,4 x 2,0	2
NEW	13.5792.042.00	for 42,4 x 2,6	2
	13.5792.248.00	for 48,3 x 2,0	2
NEW	13.5792.048.00	for 48,3 x 2,6	2
NEW	13.5792.060.00	for 60,3 x 2,0	2

316**OUTDOOR**

Ø



	14.5792.242.00	for 42,4 x 2,0	2
	14.5792.042.00	for 42,4 x 2,6	2
	14.5792.248.00	for 48,3 x 2,0	2
	14.5792.048.00	for 48,3 x 2,6	2



International Design Model Protection

MOD 0790**304****INDOOR**

Ø



	13.0790.233.12	33,7 x 2,0	2
	13.0790.142.12	42,4 x 1,5	2
	13.0790.242.12	42,4 x 2,0	2
	13.0790.042.12	42,4 x 2,6	2
	13.0790.248.12	48,3 x 2,0	2
	13.0790.048.12	48,3 x 2,6	2
	13.0790.060.12	60,3 x 2,0	2

316**OUTDOOR**

Ø

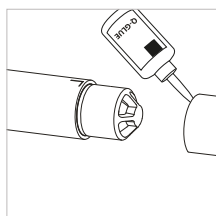
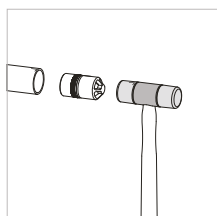

	14.0790.242.12	42,4 x 2,0	2
	14.0790.042.12	42,4 x 2,6	2
	14.0790.248.12	48,3 x 2,0	2
	14.0790.048.12	48,3 x 2,6	2

**Q-INFO**

Q-21
Q-glue
50 ml
19.1331.000.00

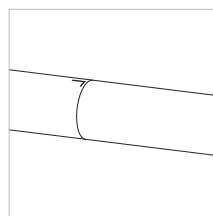
**Q-INFO**

Q-22
Q-ultra-clean
500 ml
19.0610.000.00



40 - 70°

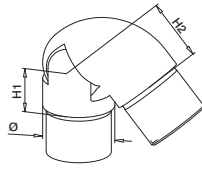

MOD 0319

316

OUTDOOR	Ø	H1	H2	☐
14.0319.242.12	42,4 x 2,0	27	35	2
14.0319.248.12	48,3 x 2,0	30	40	2



International Design Model Protection



Q-INFO

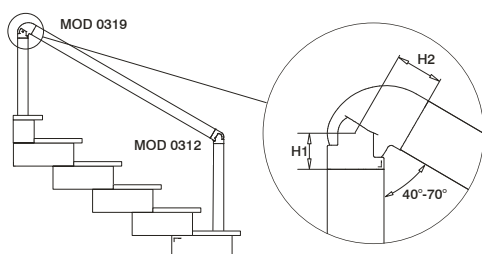

Mounting A

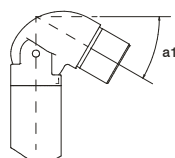

Mounting B

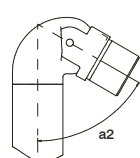



Q-INFO

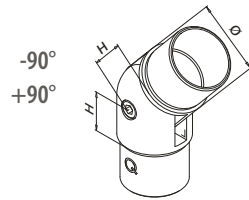

Q-22

Q-ultra-clean
500 ml
19.0610.000.00

**MOD 0302****304**

INDOOR	Ø	H	
13.0302.233.12	33,7 x 2,0	22	2
13.0302.242.12	42,4 x 2,0	27	2
13.0302.042.12	42,4 x 2,6	27	2
13.0302.248.12	48,3 x 2,0	30	2
13.0302.048.12	48,3 x 2,6	30	2

316

OUTDOOR	Ø	H	
14.0302.242.12	42,4 x 2,0	27	2
14.0302.042.12	42,4 x 2,6	27	2
14.0302.248.12	48,3 x 2,0	30	2
14.0302.048.12	48,3 x 2,6	30	2

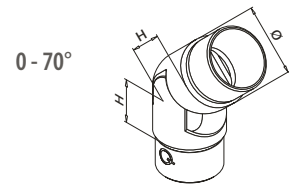
**MOD 0312****304**

INDOOR	Ø	H	
13.0312.233.12	33,7 x 2,0	30	2
13.0312.142.12	42,4 x 1,5	30	2
13.0312.242.12	42,4 x 2,0	27	2
13.0312.042.12	42,4 x 2,6	27	2
13.0312.248.12	48,3 x 2,0	30	2
13.0312.048.12	48,3 x 2,6	30	2

316

OUTDOOR	Ø	H	
14.0312.242.12	42,4 x 2,0	27	2
14.0312.042.12	42,4 x 2,6	27	2
14.0312.248.12	48,3 x 2,0	30	2
14.0312.048.12	48,3 x 2,6	30	2
14.0312.060.12	60,3 x 2,0	33	2



International Design Model Protection

Q-INFO**Q-23**

Q-cleaner
300 ml
19.0601.000.00

Q-INFO**Q-21**

Q-glue
50 ml
19.1331.000.00

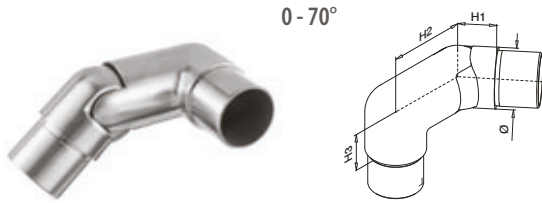

Upwards right
Downwards left**MOD 0317****304**

INDOOR	Ø	H1	H2	H3	
13.0317.242.12	42,4 x 2,0	27	60	30	2
13.0317.248.12	48,3 x 2,0	30	65	35	2

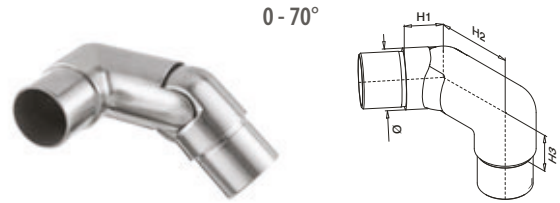
Upwards left
Downwards right**MOD 0318****304**

INDOOR	Ø	H1	H2	H3	
13.0318.242.12	42,4 x 2,0	27	60	30	2
13.0318.248.12	48,3 x 2,0	30	65	35	2



0 - 90°

**MOD 0791****304**

INDOOR	Ø	H	
13.0791.242.12	42,4 x 2,0	30	2
13.0791.248.12	48,3 x 2,0	35	2

316

OUTDOOR	Ø	H	
14.0791.242.12	42,4 x 2,0	30	2
14.0791.248.12	48,3 x 2,0	35	2



Q-INFO

MOD 0317



Q-21
Q-glue
50 ml
19.1331.000.00

90°

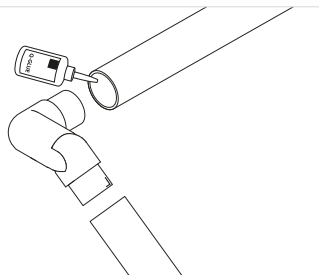

Q-INFO

MOD 0318



Q-21
Q-glue
50 ml
19.1331.000.00

90°

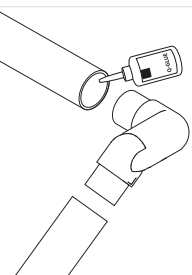

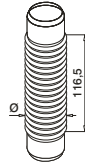
**MOD 0315**

304

INDOOR	∅	flex	
13.0315.242.12	42,4 x 2,0	0° - 135°	2
13.0315.248.12	48,3 x 2,0	0° - 135°	2

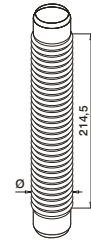
**MOD 0316**

304

INDOOR	∅	flex	
13.0316.242.12	42,4 x 2,0	0° - 210°	2
13.0316.248.12	48,3 x 2,0	0° - 210°	2

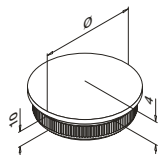

**MOD 5729 - EASY HIT®****304**

INDOOR	ø	
13.5729.233.12	33,7 x 2,0	2
13.5729.142.12	42,4 x 1,5	2
13.5729.242.12	42,4 x 2,0	2
13.5729.042.12	42,4 x 2,6	2
13.5729.248.12	48,3 x 2,0	2
13.5729.048.12	48,3 x 2,6	2

316

OUTDOOR	ø	
14.5729.242.12	42,4 x 2,0	2
14.5729.042.12	42,4 x 2,6	2
14.5729.248.12	48,3 x 2,0	2
14.5729.048.12	48,3 x 2,6	2

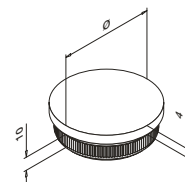
**MOD 5732 - EASY HIT®****304**

INDOOR	ø	
13.5732.233.12	33,7 x 2,0	2
13.5732.242.12	42,4 x 2,0	2
13.5732.042.12	42,4 x 2,6	2
13.5732.248.12	48,3 x 2,0	2
13.5732.048.12	48,3 x 2,6	2

316

OUTDOOR	ø	
14.5732.242.12	42,4 x 2,0	2
14.5732.042.12	42,4 x 2,6	2
14.5732.248.12	48,3 x 2,0	2
14.5732.048.12	48,3 x 2,6	2

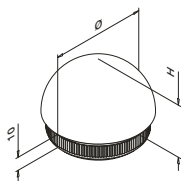
**MOD 5730 - EASY HIT®****304**

INDOOR	ø	H	
13.5730.233.12	33,7 x 2,0	17	2
13.5730.242.12	42,4 x 2,0	21	2
13.5730.042.12	42,4 x 2,6	21	2
13.5730.248.12	48,3 x 2,0	24	2

316

OUTDOOR	ø	H	
14.5730.242.12	42,4 x 2,0	21	2
14.5730.248.12	48,3 x 2,0	24	2
14.5730.048.12	48,3 x 2,6	24	2

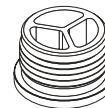
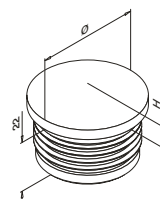
**MOD 5729 - EASY HIT®****ABS plastic**

Stainless steel effect

INDOOR	ø	H	
24.5729.233.19	33,7 x 2,0	8	2
24.5729.242.19	42,4 x 2,0	9	2
24.5729.248.19	48,3 x 2,0	9	2



Q-INFO

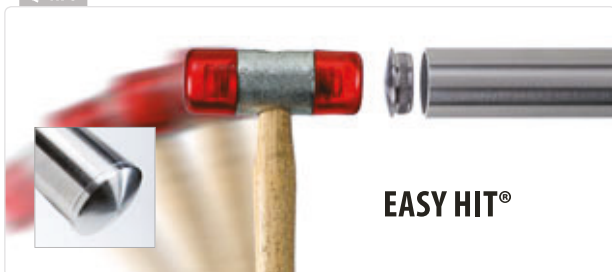

Q-INFO



Q-23
Q-cleaner
300 ml
19.0601.000.00

Q-INFO



Q-22
Q-ultra-clean
500 ml
19.0610.000.00

Q-LINE - End caps

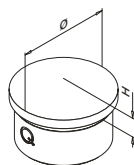

MOD 0729

304

INDOOR	\varnothing	H	
13.0729.233.12	33,7 x 2,0	8	2
13.0729.242.12	42,4 x 2,0	9	2
13.0729.042.12	42,4 x 2,6	9	2
13.0729.248.12	48,3 x 2,0	10	2
13.0729.048.12	48,3 x 2,6	10	2
13.0729.060.12	60,3 x 2,0	11	2

316

OUTDOOR	\varnothing	H	
14.0729.242.12	42,4 x 2,0	9	2
14.0729.042.12	42,4 x 2,6	9	2
14.0729.248.12	48,3 x 2,0	10	2
14.0729.048.12	48,3 x 2,6	10	2

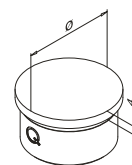

MOD 0732

304

INDOOR	\varnothing	
13.0732.233.12	33,7 x 2,0	2
13.0732.242.12	42,4 x 2,0	2
13.0732.248.12	48,3 x 2,0	2

316

OUTDOOR	\varnothing	
14.0732.242.12	42,4 x 2,0	2
14.0732.248.12	48,3 x 2,0	2



For stairs

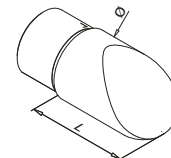

Q-LINE - End scrolls

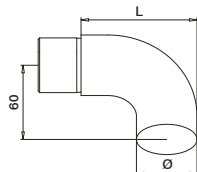

MOD 0739

304

INDOOR	\varnothing	L	
13.0739.233.12	33,7 x 2,0	77	2
13.0739.242.12	42,4 x 2,0	81	2
13.0739.042.12	42,4 x 2,6	81	2
13.0739.248.12	48,3 x 2,0	84	2
13.0739.048.12	48,3 x 2,6	84	2

316

OUTDOOR	\varnothing	L	
14.0739.242.12	42,4 x 2,0	81	2
14.0739.042.12	42,4 x 2,6	81	2
14.0739.248.12	48,3 x 2,0	84	2
14.0739.048.12	48,3 x 2,6	84	2



MOD 0738

304

INDOOR	\varnothing	L	
13.0738.242.12	42,4 x 2,0	60	2
13.0738.248.12	48,3 x 2,0	65	2

316

OUTDOOR	\varnothing	L	
14.0738.242.12	42,4 x 2,0	60	2
14.0738.248.12	48,3 x 2,0	65	2



International Design Model Protection

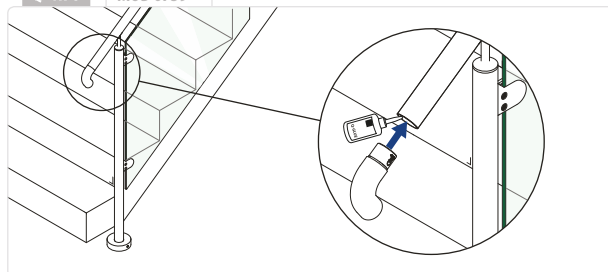
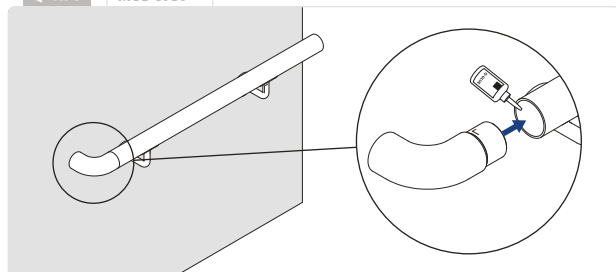

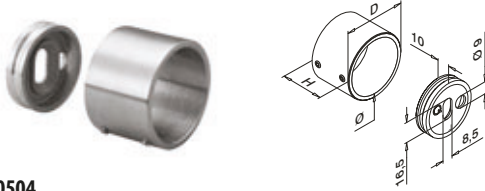
**MOD 0504****304**

INDOOR	Ø	D	H			
13.0504.033.12	33,7	41	30	QS-55	305 / QS-21	303 2
13.0504.042.12	42,4	50	35	QS-55	305 / QS-21	303 2
13.0504.048.12	48,3	56	35	QS-55	305 / QS-21	303 2

316

OUTDOOR	Ø	D	H			
14.0504.042.12	42,4	50	35	QS-55	305 / QS-22	303 2
14.0504.048.12	48,3	56	35	QS-55	305 / QS-22	303 2

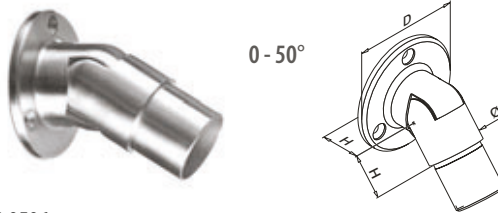
**MOD 0506****304**

INDOOR	Ø	D	H			
13.0506.233.12	33,7 x 2,0	70	26	QS-7	302	2
13.0506.242.12	42,4 x 2,0	75	30	QS-7	302	2
13.0506.248.12	48,3 x 2,0	80	33	QS-7	302	2



DESIGN product

International Design Model Protection

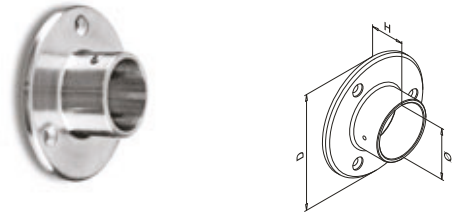
**MOD 0505****304**

INDOOR	Ø	D	H			
13.0505.033.12	33,7	Ø 85	30	QS-7	302	2
13.0505.042.12	42,4	Ø 95	30	QS-7	302	2
13.0505.048.12	48,3	Ø 100	35	QS-7	302	2
13.0505.060.12	60,3	Ø 115	40	QS-7	302	2

316

OUTDOOR	Ø	D	H			
14.0505.042.12	42,4	Ø 95	30	QS-50	302	2
14.0505.048.12	48,3	Ø 100	35	QS-50	302	2

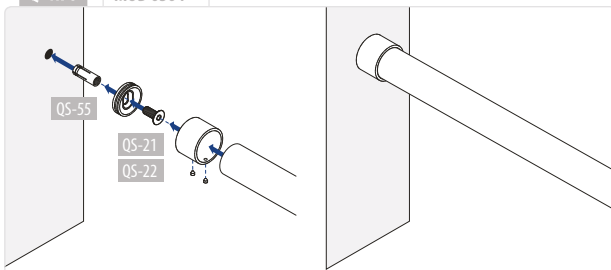
**MOD 0515**
143**Q-INFO****MOD 0504****Q-INFO****Q-23**
Q-cleaner
300 ml
19.0601.000.00**Q-INFO****Q-22**
Q-ultra-clean
500 ml
19.0610.000.00



POLISHED

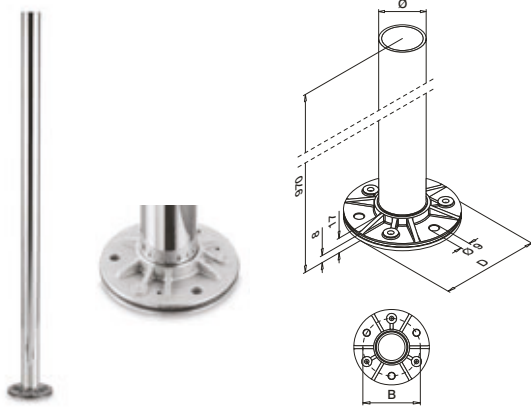

MOD 0913

304

INDOOR	Ø	B	D		
13.0913.048.10	48,3 x 2,6	90	Ø 115	QS-35	310 1

316

OUTDOOR	Ø	B	D		
14.0913.048.10	48,3 x 2,6	90	Ø 115	QS-34	310 1

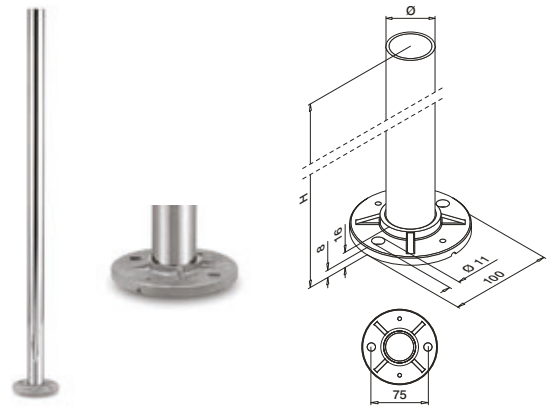

MOD 0914

304

INDOOR	Ø	H		
13.0914.242.10	42,4 x 2,0	970	QS-59	310 1

316

OUTDOOR	Ø	H		
14.0914.242.10	42,4 x 2,0	970	QS-58	310 1



MOD 0511

304

INDOOR	Ø	D	
13.0511.042.10	42,4	Ø 110	2
13.0511.048.10	48,3	Ø 120	2

316

OUTDOOR	Ø	D	
14.0511.042.10	42,4	Ø 110	2
14.0511.048.10	48,3	Ø 120	2



MOD 0512

304

INDOOR	Ø	D	
13.0512.042.10	42,4	Ø 105	2

316

OUTDOOR	Ø	D	
14.0512.042.10	42,4	Ø 105	2

Q-INFO

MOD 0913 / 0511



Rubber ring



Infills

POLISHED

Q-LINE - Glass clamps

Tube

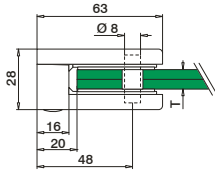
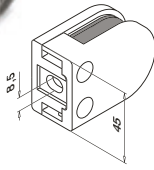
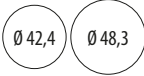

MOD 22 - Ø 42,4 / Ø 48,3 mm

304

INDOOR	D	T		
13.2206.042.10	Ø 42,4	6	QS-47	301
13.2208.042.10	Ø 42,4	8	QS-47	301
13.2210.042.10	Ø 42,4	10	QS-47	301
13.2206.048.10	Ø 48,3	6	QS-47	301
13.2208.048.10	Ø 48,3	8	QS-47	301
13.2210.048.10	Ø 48,3	10	QS-47	301



304

INDOOR	D	T		
13.2207.042.10	Ø 42,4	6,76 (3 - 0,76 - 3)	QS-47	301
13.2209.042.10	Ø 42,4	8,76 (4 - 0,76 - 4)	QS-47	301
13.2244.042.10	Ø 42,4	9,52 (4 - 1,52 - 4)	QS-47	301
13.2207.048.10	Ø 48,3	6,76 (3 - 0,76 - 3)	QS-47	301
13.2209.048.10	Ø 48,3	8,76 (4 - 0,76 - 4)	QS-47	301
13.2244.048.10	Ø 48,3	9,52 (4 - 1,52 - 4)	QS-47	301



316

OUTDOOR	D	T		
14.2206.042.10	Ø 42,4	6	QS-45	301
14.2208.042.10	Ø 42,4	8	QS-45	301
14.2210.042.10	Ø 42,4	10	QS-45	301
14.2206.048.10	Ø 48,3	6	QS-45	301
14.2208.048.10	Ø 48,3	8	QS-45	301
14.2210.048.10	Ø 48,3	10	QS-45	301



316

OUTDOOR	D	T		
14.2207.042.10	Ø 42,4	6,76 (3 - 0,76 - 3)	QS-45	301
14.2209.042.10	Ø 42,4	8,76 (4 - 0,76 - 4)	QS-45	301
14.2244.042.10	Ø 42,4	9,52 (4 - 1,52 - 4)	QS-45	301
14.2207.048.10	Ø 48,3	6,76 (3 - 0,76 - 3)	QS-45	301
14.2209.048.10	Ø 48,3	8,76 (4 - 0,76 - 4)	QS-45	301
14.2244.048.10	Ø 48,3	9,52 (4 - 1,52 - 4)	QS-45	301



Accessories

Security pins for glass clamps

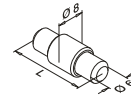

MOD 5015

Accessories	L	
19.5015.022.00	22	4

Please order security pins and fixing bolts separately.

Q-INFO



Q-23
Q-cleaner
300 ml
19.0601.000.00

Q-INFO



Q-22
Q-ultra-clean
500 ml
19.0610.000.00

Q-INFO

MOD 5015

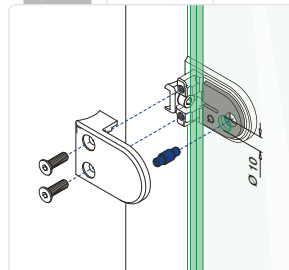

Flat

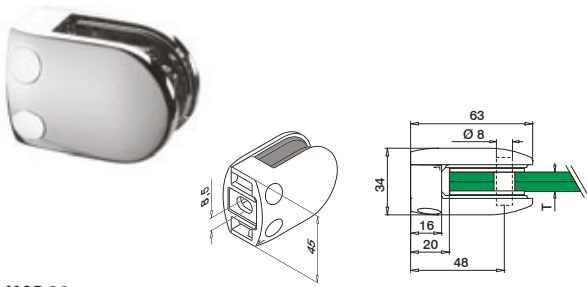

MOD 28



304				
INDOOR	T			
13.2806.000.10	6	QS-47	301	4
13.2808.000.10	8	QS-47	301	4
13.2810.000.10	10	QS-47	301	4
13.2812.000.10	12	QS-47	301	4



304				
INDOOR	T			
13.2807.000.10	6,76 (3 - 0,76 - 3)	QS-47	301	4
13.2841.000.10	8,38 (4 - 0,38 - 4)	QS-47	301	4
13.2809.000.10	8,76 (4 - 0,76 - 4)	QS-47	301	4
13.2844.000.10	9,52 (4 - 1,52 - 4)	QS-47	301	4
13.2811.000.10	10,76 (5 - 0,76 - 5)	QS-47	301	4
13.2854.000.10	11,52 (5 - 1,52 - 5)	QS-47	301	4
13.2813.000.10	12,76 (6 - 0,76 - 6)	QS-47	301	4

DESIGN
product

International Design Model Protection

Accessories

Security pins for glass clamps



MOD 5015

Accessories

	L	
19.5015.022.00	22	4

Tube

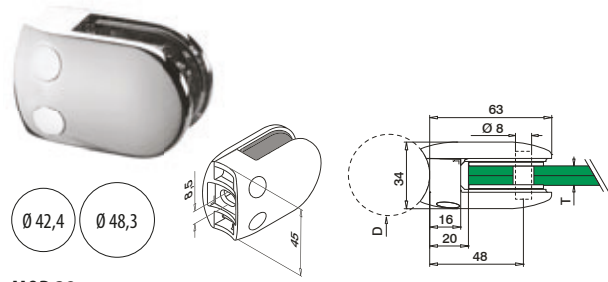

MOD 28



304				
INDOOR	D	T		
13.2806.042.10	Ø 42,4	6	QS-47	301
13.2808.042.10	Ø 42,4	8	QS-47	301
13.2810.042.10	Ø 42,4	10	QS-47	301
13.2812.042.10	Ø 42,4	12	QS-47	301
13.2806.048.10	Ø 48,3	6	QS-47	301
13.2808.048.10	Ø 48,3	8	QS-47	301
13.2810.048.10	Ø 48,3	10	QS-47	301
13.2812.048.10	Ø 48,3	12	QS-47	301



304				
INDOOR	D	T		
13.2807.042.10	Ø 42,4	6,76 (3 - 0,76 - 3)	QS-47	301
13.2841.042.10	Ø 42,4	8,38 (4 - 0,38 - 4)	QS-47	301
13.2809.042.10	Ø 42,4	8,76 (4 - 0,76 - 4)	QS-47	301
13.2844.042.10	Ø 42,4	9,52 (4 - 1,52 - 4)	QS-47	301
13.2811.042.10	Ø 42,4	10,76 (5 - 0,76 - 5)	QS-47	301
13.2854.042.10	Ø 42,4	11,52 (5 - 1,52 - 5)	QS-47	301
13.2813.042.10	Ø 42,4	12,76 (6 - 0,76 - 6)	QS-47	301
13.2807.048.10	Ø 48,3	6,76 (3 - 0,76 - 3)	QS-47	301
13.2841.048.10	Ø 48,3	8,38 (4 - 0,38 - 4)	QS-47	301
13.2809.048.10	Ø 48,3	8,76 (4 - 0,76 - 4)	QS-47	301
13.2844.048.10	Ø 48,3	9,52 (4 - 1,52 - 4)	QS-47	301
13.2811.048.10	Ø 48,3	10,76 (5 - 0,76 - 5)	QS-47	301
13.2854.048.10	Ø 48,3	11,52 (5 - 1,52 - 5)	QS-47	301
13.2813.048.10	Ø 48,3	12,76 (6 - 0,76 - 6)	QS-47	301

DESIGN
product

International Design Model Protection

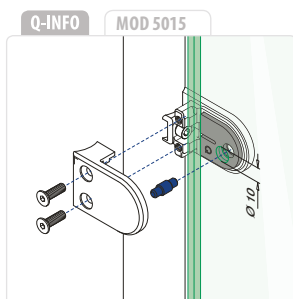

Please order security pins and fixing bolts separately.

Flat

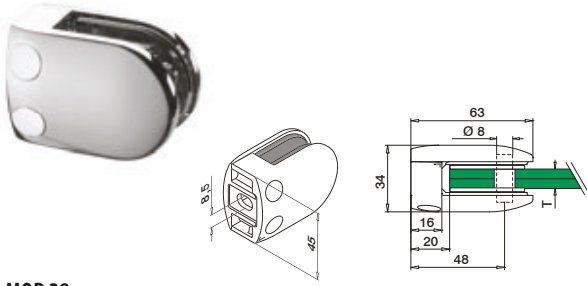

MOD 28

MONO		316		OUTDOOR		T		
14.2806.000.10		6	QS-45	301	4			
14.2808.000.10		8	QS-45	301	4			
14.2810.000.10		10	QS-45	301	4			
14.2812.000.10		12	QS-45	301	4			

LAM.		316		OUTDOOR		T		
14.2807.000.10		6,76 (3 - 0,76 - 3)	QS-45	301	4			
14.2841.000.10		8,38 (4 - 0,38 - 4)	QS-45	301	4			
14.2809.000.10		8,76 (4 - 0,76 - 4)	QS-45	301	4			
14.2844.000.10		9,52 (4 - 1,52 - 4)	QS-45	301	4			
14.2811.000.10		10,76 (5 - 0,76 - 5)	QS-45	301	4			
14.2854.000.10		11,52 (5 - 1,52 - 5)	QS-45	301	4			
14.2813.000.10		12,76 (6 - 0,76 - 6)	QS-45	301	4			



International Design Model Protection

Accessories

Security pins for glass clamps



MOD 5015

Accessories		L	
19.5015.022.00		22	4

Tube

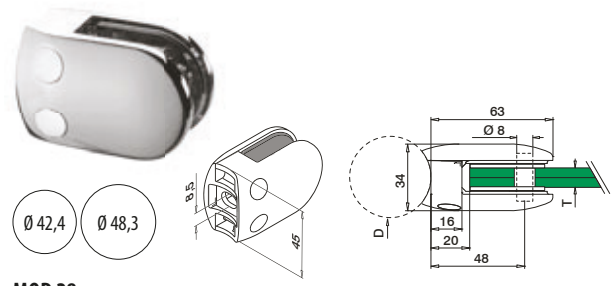

MOD 28

MONO		316		OUTDOOR		D	T		
14.2806.042.10		Ø 42,4	6	QS-45	301	4			
14.2808.042.10		Ø 42,4	8	QS-45	301	4			
14.2810.042.10		Ø 42,4	10	QS-45	301	4			
14.2812.042.10		Ø 42,4	12	QS-45	301	4			
14.2806.048.10		Ø 48,3	6	QS-45	301	4			
14.2808.048.10		Ø 48,3	8	QS-45	301	4			
14.2810.048.10		Ø 48,3	10	QS-45	301	4			
14.2812.048.10		Ø 48,3	12	QS-45	301	4			

LAM.		316		OUTDOOR		D	T		
14.2807.042.10		Ø 42,4	6,76 (3 - 0,76 - 3)	QS-45	301	4			
14.2841.042.10		Ø 42,4	8,38 (4 - 0,38 - 4)	QS-45	301	4			
14.2809.042.10		Ø 42,4	8,76 (4 - 0,76 - 4)	QS-45	301	4			
14.2844.042.10		Ø 42,4	9,52 (4 - 1,52 - 4)	QS-45	301	4			
14.2811.042.10		Ø 42,4	10,76 (5 - 0,76 - 5)	QS-45	301	4			
14.2854.042.10		Ø 42,4	11,52 (5 - 1,52 - 5)	QS-45	301	4			
14.2813.042.10		Ø 42,4	12,76 (6 - 0,76 - 6)	QS-45	301	4			
14.2807.048.10		Ø 48,3	6,76 (3 - 0,76 - 3)	QS-45	301	4			
14.2841.048.10		Ø 48,3	8,38 (4 - 0,38 - 4)	QS-45	301	4			
14.2809.048.10		Ø 48,3	8,76 (4 - 0,76 - 4)	QS-45	301	4			
14.2844.048.10		Ø 48,3	9,52 (4 - 1,52 - 4)	QS-45	301	4			
14.2811.048.10		Ø 48,3	10,76 (5 - 0,76 - 5)	QS-45	301	4			
14.2854.048.10		Ø 48,3	11,52 (5 - 1,52 - 5)	QS-45	301	4			
14.2813.048.10		Ø 48,3	12,76 (6 - 0,76 - 6)	QS-45	301	4			



International Design Model Protection

Q-INFO

MOD 5015

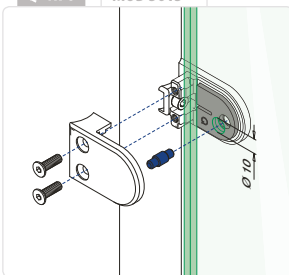

Please order security pins and fixing bolts separately.

Infills

POLISHED

Q-LINE - Crossbar holders

Tube - bar

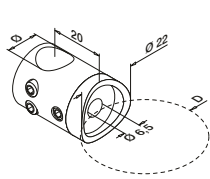

MOD 0831 - Ø 12 mm

304

INDOOR	Ø	D	Accessories	Quantity
13.0831.042.10	12	Ø 42,4	QS-15 303	4

316

OUTDOOR	Ø	D	Accessories	Quantity
14.0831.042.10	12	Ø 42,4	QS-16 303	4



Infills

POLISHED

Q-LINE - Bars

Q-TUBE

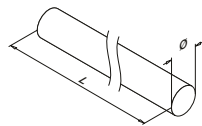

MOD 0900 / 8925 - Ø 12 mm

304

INDOOR	Ø	Length
13.8925.012.10	12	L = 2500 mm
13.0900.012.10	12	L = 5000 mm

316

OUTDOOR	Ø	Length
14.8925.012.10	12	L = 2500 mm
14.0900.012.10	12	L = 5000 mm



Q-INFO



Save time and money with Q-tube.

Q-tube has a far lower tolerance than a standard commercial tube. Even the welding seam of Q-tube has been specially adapted to our fittings. Therefore the tube fits perfectly in conjunction with our fittings, in order for you to be able to work fast and effectively. To prevent damage, and to guarantee the quality, each tube section is separately packaged.

Q-INFO

Calculation basis for bars

calculated by ONDRA

	Ø (mm)	A (cm ²)	I _x =I _y (cm ⁴)	W _x =W _y (cm ³)	M (kg/m)	R _{p0,2} (kN/cm ²)	R _m (kN/cm ²)
13.0900.012.10	12	1,13	0,10	0,17	0,88	23	54
13.8925.012.10							
14.0900.012.10	12	1,13	0,10	0,17	0,88	24	53
14.8925.012.10							

A = cross sectional area
I_x / I_y = second moment of area
W_x / W_y = section modulus

M = weight
R_{p0,2} = permissible stress
R_m = minimum tensile strength

Q-INFO

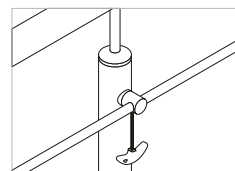
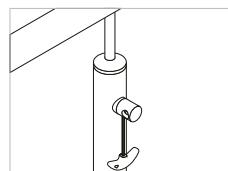
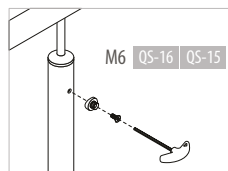
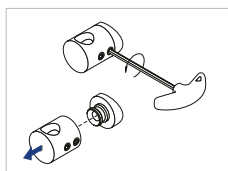
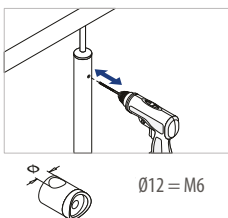

Q-Video www.q-railing.com

Flat - plate

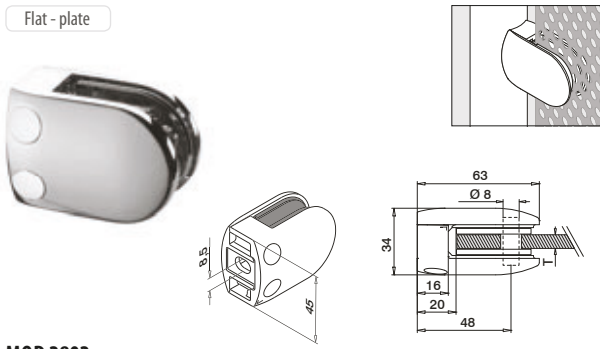

MOD 2802

304				
INDOOR	T			
13.2802.000.10	2		QS-47 301	4

316				
OUTDOOR	T			
14.2802.000.10	2		QS-45 301	4

MOD 2803

304				
INDOOR	T			
13.2803.000.10	3		QS-47 301	4

316				
OUTDOOR	T			
14.2803.000.10	3		QS-45 301	4

MOD 2804

304				
INDOOR	T			
13.2804.000.10	4		QS-47 301	4

316				
OUTDOOR	T			
14.2804.000.10	4		QS-45 301	4



International Design Model Protection

Accessories

Security pins for plate adapters

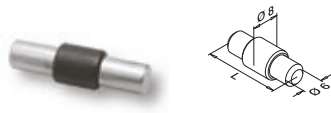

MOD 5015

Accessories				
	L			
19.5015.022.00	22			4

Tube - plate

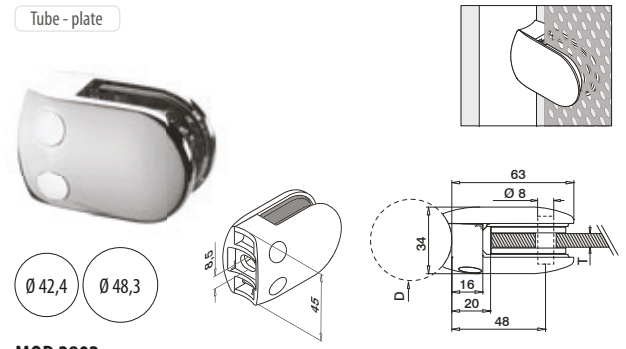

MOD 2802

304				
INDOOR	D	T		
13.2802.042.10	Ø 42,4	2		QS-47 301 4
13.2802.048.10	Ø 48,3	2		QS-47 301 4

316				
OUTDOOR	D	T		
14.2802.042.10	Ø 42,4	2		QS-45 301 4
14.2802.048.10	Ø 48,3	2		QS-45 301 4

MOD 2803

304				
INDOOR	D	T		
13.2803.042.10	Ø 42,4	3		QS-47 301 4
13.2803.048.10	Ø 48,3	3		QS-47 301 4

316				
OUTDOOR	D	T		
14.2803.042.10	Ø 42,4	2		QS-45 301 4
14.2803.048.10	Ø 48,3	2		QS-45 301 4

MOD 2804

304				
INDOOR	D	T		
13.2804.042.10	Ø 42,4	4		QS-47 301 4
13.2804.048.10	Ø 48,3	4		QS-47 301 4

316				
OUTDOOR	D	T		
14.2804.042.10	Ø 42,4	4		QS-45 301 4
14.2804.048.10	Ø 48,3	4		QS-45 301 4



International Design Model Protection

Q-INFO

MOD 5015

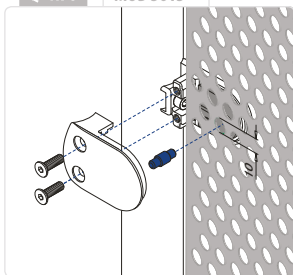

Please order security pins and fixing bolts separately.

Wall - tube

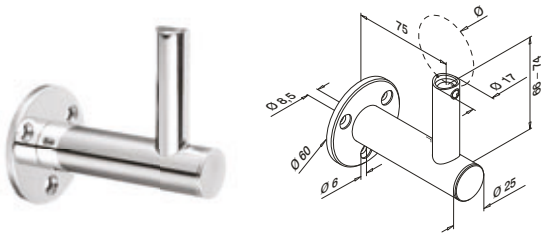

MOD 0142

304

INDOOR	Ø			
13.0142.044.10	42,4 / 48,3	QS-556	302 / QS-555	305
		QS-7	302 / QS-25	303 / QS-87

316

OUTDOOR	Ø			
14.0142.044.10	42,4 / 48,3	QS-556	302 / QS-555	305
		QS-50	302 / QS-71	303 / QS-87

NEW

International Design
Model Protection

Posts

SATIN

Q-LINE - Cover caps



MOD 0520

304

INDOOR	For MOD	
13.0520.066.10	0142	2

316

OUTDOOR	For MOD	
14.0520.066.10	0142	2

NEW

Wall - tube

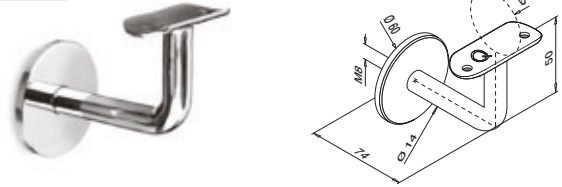

MOD 0111

304

INDOOR	Ø			
13.0111.042.10	42,4	QS-1	302 / QS-10	302
13.0111.048.10	48,3	QS-1	302 / QS-10	302

316

OUTDOOR	Ø			
14.0111.042.10	42,4	QS-2	302 / QS-11	302
14.0111.048.10	48,3	QS-2	302 / QS-11	302



Wall - tube

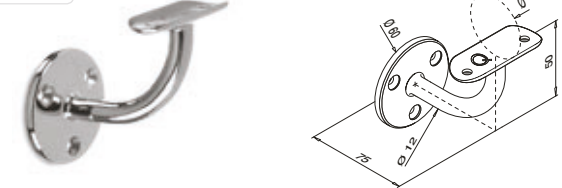

MOD 0112

304

INDOOR	Ø			
13.0112.042.10	42,4	QS-7	302 / QS-10	302
13.0112.048.10	48,3	QS-7	302 / QS-10	302

316

OUTDOOR	Ø			
14.0112.042.10	42,4	QS-50	302 / QS-11	302
14.0112.048.10	48,3	QS-50	302 / QS-11	302



Q-INFO MOD 0142

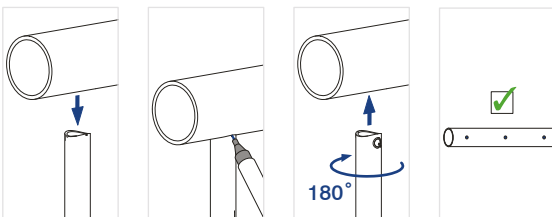

Q-INFO MOD 0111 / 0112

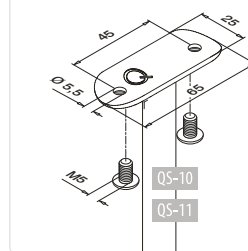

Q-INFO MOD 0520

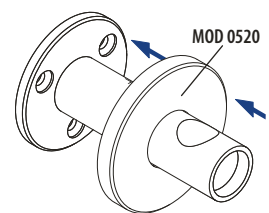

Q-INFO MOD 0142

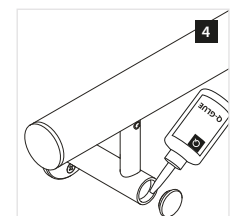
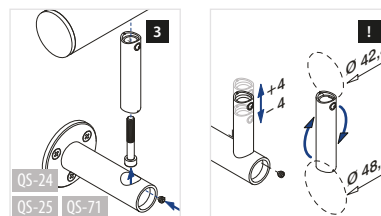
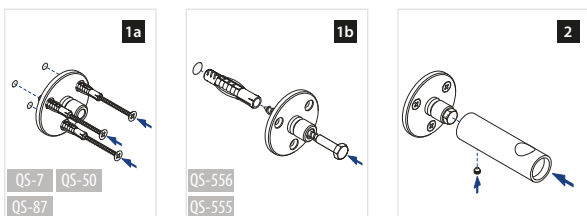

Tube - tube

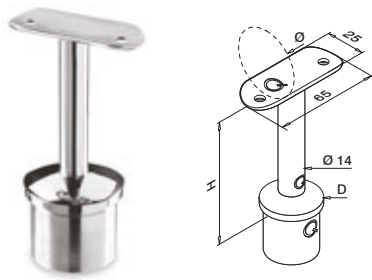
**MOD 0710** - D 42,4 mm**304**

INDOOR	D	H	Ø		
13.0710.242.10	Ø 42,4 x 2,0	79	42,4	QS-10	302 2

316

OUTDOOR	D	H	Ø		
14.0710.242.10	Ø 42,4 x 2,0	79	42,4	QS-11	302 2

MOD 0711 - D 48,3 mm**304**

INDOOR	D	H	Ø		
13.0711.048.10	Ø 48,3 x 2,6	80	48,3	QS-10	302 2

316

OUTDOOR	D	H	Ø		
14.0711.048.10	Ø 48,3 x 2,6	80	48,3	QS-11	302 2

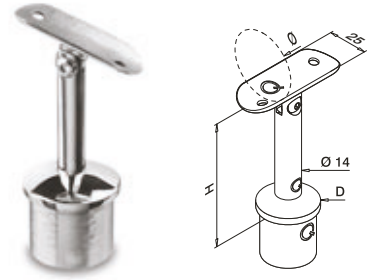

Tube - tube

**MOD 0718** - D 42,4 mm**304**

INDOOR	D	H	Ø		
13.0718.242.10	Ø 42,4 x 2,0	79	42,4	QS-10	302 2

316

OUTDOOR	D	H	Ø		
14.0718.242.10	Ø 42,4 x 2,0	79	42,4	QS-11	302 2

MOD 0719 - D 48,3 mm**304**

INDOOR	D	H	Ø		
13.0719.048.10	Ø 48,3 x 2,6	80	48,3	QS-10	302 2

316

OUTDOOR	D	H	Ø		
14.0719.048.10	Ø 48,3 x 2,6	80	48,3	QS-11	302 2

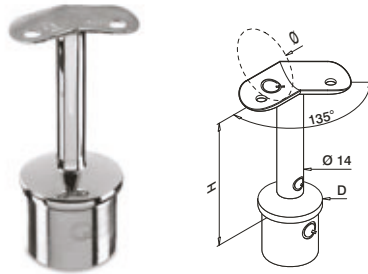

Tube - tube

**MOD 0710** - D 42,4 mm**304**

INDOOR	D	H	Ø		
13.0710.342.10	Ø 42,4 x 2,0	79	42,4	QS-10	302 2

316

OUTDOOR	D	H	Ø		
14.0710.342.10	Ø 42,4 x 2,0	79	42,4	QS-11	302 2

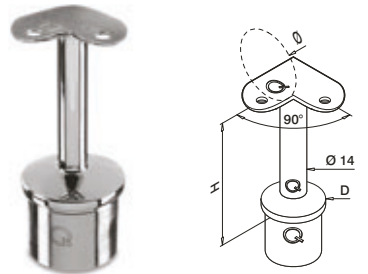

Tube - tube

**MOD 0710** - D 42,4 mm**304**

INDOOR	D	H	Ø		
13.0710.842.10	Ø 42,4 x 2,0	79	42,4	QS-10	302 2

316

OUTDOOR	D	H	Ø		
14.0710.842.10	Ø 42,4 x 2,0	79	42,4	QS-11	302 2

**MOD 0711** - D 48,3 mm**316**

OUTDOOR	D	H	Ø		
14.0711.948.10	Ø 48,3 x 2,6	80	48,3	QS-11	302 2



Q-INFO MOD 0710.3xx

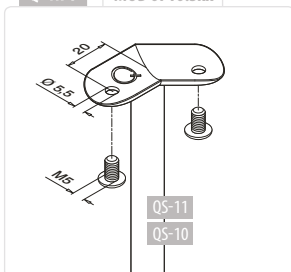

Q-INFO MOD 0710.3xx

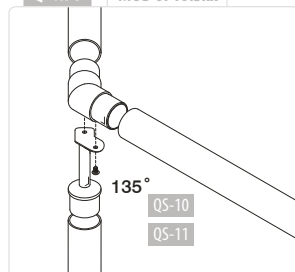

Q-INFO MOD 0710.8xx/0711.9xx

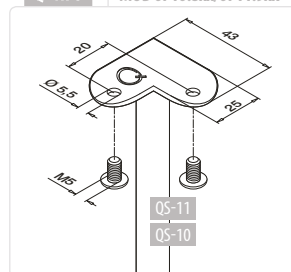

Q-INFO MOD 0710.8xx/0711.9xx

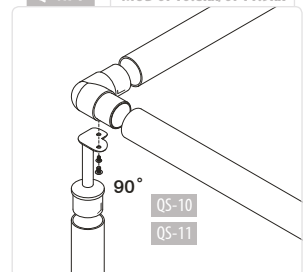

Tube - tube

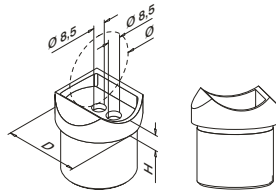
**MOD 0772** - D 42,4 mm**304**

INDOOR	D	Ø	H		
13.0772.242.10	Ø 42,4 x 2,0	42,4	9	Q5-26	303 2

316

OUTDOOR	D	Ø	H		
14.0772.242.10	Ø 42,4 x 2,0	42,4	9	Q5-27	303 2

MOD 0771 - D 48,3 mm**316**

OUTDOOR	D	Ø	H		
14.0771.048.10	Ø 48,3 x 2,6	48,3	11	Q5-27	303 2



Q-INFO

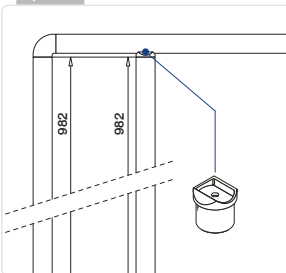

Q-INFO



Q-21
Q-glue
50 ml
19.1331.000.00

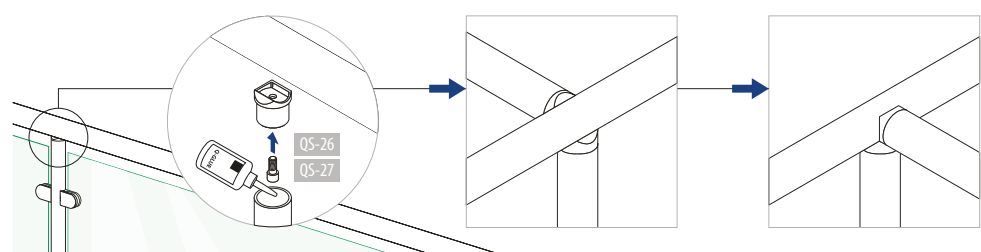

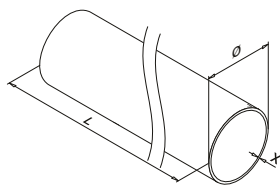
**MOD 8925 / 0900**

Ø 42,4 mm

304

INDOOR	X	
13.8925.242.10	2,0	L = 2500 mm
13.0900.242.10	2,0	L = 5000 mm

316

OUTDOOR	X	
14.8925.242.10	2,0	L = 2500 mm
14.0900.242.10	2,0	L = 5000 mm

Ø 48,3 mm

304

INDOOR	X	
13.8925.048.10	2,6	L = 2500 mm
13.0900.048.10	2,6	L = 5000 mm

316

OUTDOOR	X	
14.8925.048.10	2,6	L = 2500 mm
14.0900.048.10	2,6	L = 5000 mm

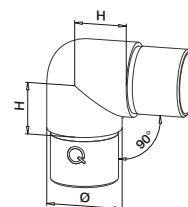
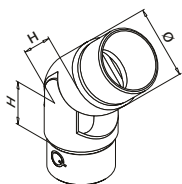

0 - 70°

**MOD 0312****304**

INDOOR	Ø	H	
13.0312.242.10	42,4 x 2,0	27	2
13.0312.048.10	48,3 x 2,6	30	2

316

OUTDOOR	Ø	H	
14.0312.242.10	42,4 x 2,0	27	2
14.0312.048.10	48,3 x 2,6	30	2

DESIGN
product

International Design Model Protection

MOD 0303**304**

INDOOR	Ø	H	
13.0303.242.10	42,4 x 2,0	30	2
13.0303.048.10	48,3 x 2,6	35	2

316

OUTDOOR	Ø	H	
14.0303.242.10	42,4 x 2,0	30	2
14.0303.048.10	48,3 x 2,6	35	2



Suitable with MOD 0710 (handrailing brackets)

Calculation basis for tubes

calculated by ONDRA

	Ø (mm)	A (cm ²)	I _x =I _y (cm ⁴)	W _x =W _y (cm ³)	M (kg/m)	R _{p0,2} (kN/cm ²)	R _m (kN/cm ²)
13.0900.242.10 / 13.8925.242.10	42,4 x 2,0	2,53	5,19	2,44	1,98	23	54
14.0900.242.10 / 14.8925.242.10	42,4 x 2,0	2,53	5,19	2,44	1,98	24	53
13.0900.248.10 / 13.8925.248.10	48,3 x 2,0	2,90	7,80	3,23	2,28	23	54
14.0900.248.10 / 14.8925.248.10	48,3 x 2,0	2,90	7,80	3,23	2,28	24	53

A = cross sectional area
 I_x / I_y = second moment of area
 W_x / W_y = section modulus
 M = weight
 R_{p0,2} = permissible stress
 R_m = minimum tensile strength

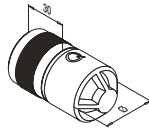

MOD 5792- EASY HIT®

304

INDOOR	Ø	
13.5792.242.00	for 42,4 x 2,0	2

316

OUTDOOR	Ø	
14.5792.242.00	for 42,4 x 2,0	2
14.5792.048.00	for 48,3 x 2,6	2



International Design Model Protection

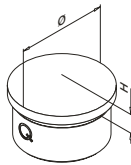

MOD 0729

304

INDOOR	Ø	H	
13.0729.242.10	42,4 x 2,0	9	2
13.0729.048.10	48,3 x 2,6	10	2

316

OUTDOOR	Ø	H	
14.0729.242.10	42,4 x 2,0	9	2
14.0729.048.10	48,3 x 2,6	10	2

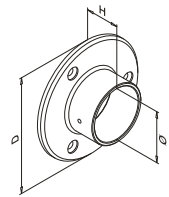

MOD 0505

304

INDOOR	Ø	D	H			
13.0505.042.10	42,4	Ø 95	30	QS-7	302	2
13.0505.048.10	48,3	Ø 100	35	QS-7	302	2

316

OUTDOOR	Ø	D	H			
14.0505.042.10	42,4	Ø 95	30	QS-50	302	2
14.0505.048.10	48,3	Ø 100	35	QS-50	302	2

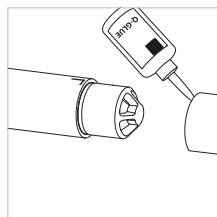
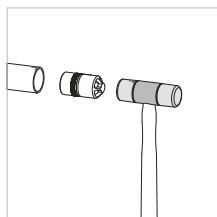

Q-21
Q-glue
50 ml
19.1331.000.00

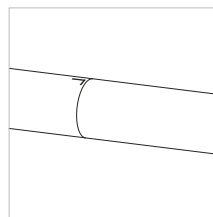

Q-23
Q-cleaner
300 ml
19.0601.000.00



Q-21
Q-glue
50 ml
19.1331.000.00



Q-glue space



Q-22
Q-ultra-clean
500 ml
19.0610.000.00



WELDING PARTS

WELDING PARTS - Flanges for baluster posts

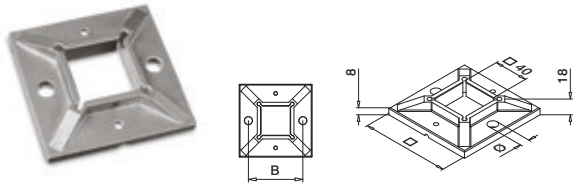

MOD 4940

304						
INDOOR	□	∅	B			
13.4940.040.00	100	11	75	QS-59	310	2

316						
OUTDOOR	□	∅	B			
14.4940.040.00	100	11	75	QS-58	310	2

MOD 4945

304						
INDOOR	□	∅	B			
13.4945.040.00	86	8,5	70	QS-35	310	2



MOD 4511
102

MOD 4925, 4900
115

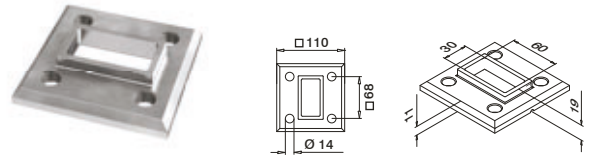

MOD 3503

316						
OUTDOOR	□					
14.3503.063.00	110			QS-559	308	2



MOD 4513
123

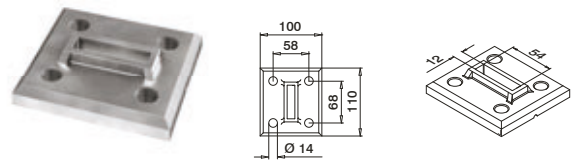

MOD 3503

316						
OUTDOOR	□					
14.3503.054.00				QS-559	308	2



MOD 9013
92

WELDING PARTS - Baluster brackets

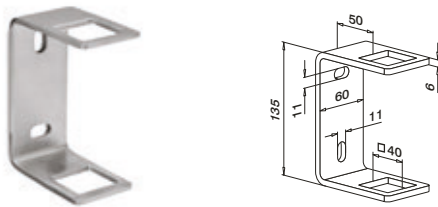

MOD 4550

304						
INDOOR	□					
13.4550.040.12	40 x 40			QS-65	306	1

316						
OUTDOOR	□					
14.4550.040.12	40 x 40			QS-64	306	1



Q-INFO

All products on this page will be delivered with satin surfaces and machined sides and edges.

Q-INFO



Q-23
Q-cleaner
300 ml
19.0601.000.00

WELDING PARTS - Flanges for baluster posts

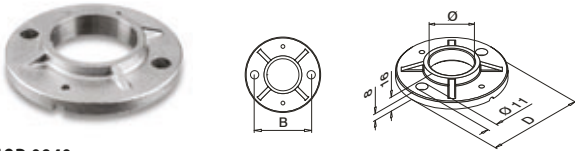

MOD 0940

304

INDOOR	Ø	B	D		
13.0940.042.00	42,4	75	Ø 100	QS-59	310 2
13.0940.048.00	48,3	80	Ø 100	QS-59	310 2

316

OUTDOOR	Ø	B	D		
14.0940.042.00	42,4	75	Ø 100	QS-58	310 2
14.0940.048.00	48,3	80	Ø 100	QS-58	310 2

MOD 0941

304

INDOOR	Ø	B	D		
13.0941.042.00	42,4	90	Ø 120	QS-59	310 2
13.0941.048.00	48,3	90	Ø 120	QS-59	310 2

316

OUTDOOR	Ø	B	D		
14.0941.042.00	42,4	90	Ø 120	QS-58	310 2
14.0941.048.00	48,3	90	Ø 120	QS-58	310 2

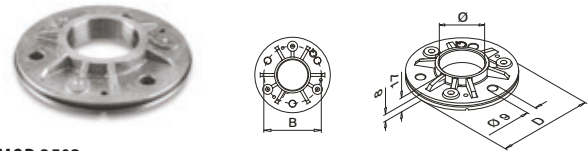

MOD 3502

304

INDOOR	Ø	B	D		
13.3502.042.00	42,4	80	Ø 105	QS-35	310 2
13.3502.048.00	48,3	90	Ø 115	QS-35	310 2

316

OUTDOOR	Ø	B	D		
14.3502.042.00	42,4	80	Ø 105	QS-34	310 2
14.3502.048.00	48,3	90	Ø 115	QS-34	310 2

MOD 0512, 0513
142, 212MOD 8925, 0900
198, 223MOD 0512, 0513
142, 212

WELDING PARTS - Baluster brackets

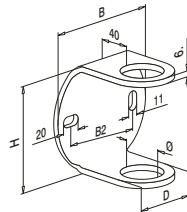

MOD 1550

304

INDOOR	Ø	H	B	B2	D		
13.1550.033.12	33,7	95	100	70	55	QS-65	306 1
13.1550.042.12	42,4	110	120	85	65	QS-65	306 1
13.1550.048.12	48,3	110	120	85	75	QS-65	306 1

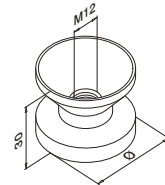

MOD 3501

304

INDOOR	Ø	
13.3501.242.00	42,4 x 2,0	2
13.3501.042.00	42,4 x 2,6	2



See pages 197 and 198 for more information about tubes.

WELDING PARTS - End caps for baluster posts and tubes

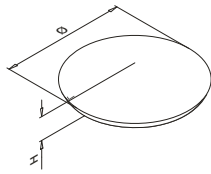

MOD 1729

304

INDOOR	\varnothing	H	
13.1729.042.12	42,4	8,5	16
13.1729.048.12	48,3	9,5	16

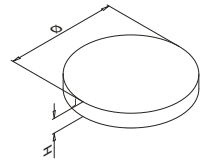

MOD 1732

304

INDOOR	\varnothing	H	
13.1732.060.12	60,0	4	8



WELDING PARTS - Connectors for handrails

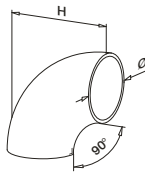

MOD 1305

304

INDOOR	\varnothing	H	
13.1305.233.12	33,7 x 2,0	50	2
13.1305.242.12	42,4 x 2,0	65	2
13.1305.248.12	48,3 x 2,0	75	2



WELDING PARTS - Flanges for handrails

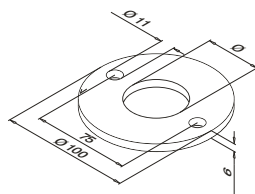

MOD 1940

304

INDOOR	\varnothing	
13.1940.042.12	42,4	4



Q-INFO

All products on this page will be delivered with satin surfaces and machined sides and edges.

Q-INFO

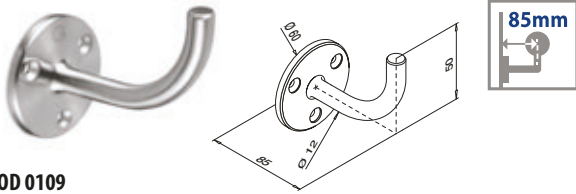

Q-23
Q-cleaner
300 ml
19.0601.000.00

**MOD 0109****304**

INDOOR		
13.0109.000.12	QS-7 302	2

316

OUTDOOR		
14.0109.000.12	QS-50 302 / QS-87 305	2

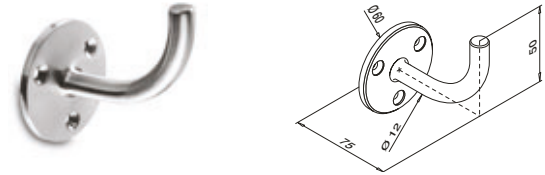
**MOD 0113****304**

INDOOR		
13.0113.000.12	QS-7 302	2

316

OUTDOOR		
14.0113.000.12	QS-50 302 / QS-87 305	2

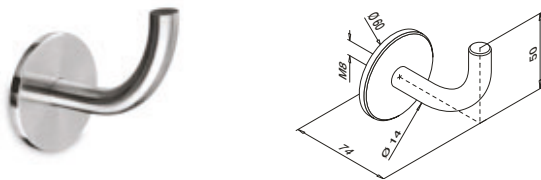
**MOD 0114****304**

INDOOR		
13.0114.000.12	QS-1 302	2

316

OUTDOOR		
14.0114.000.12	QS-2 302	2

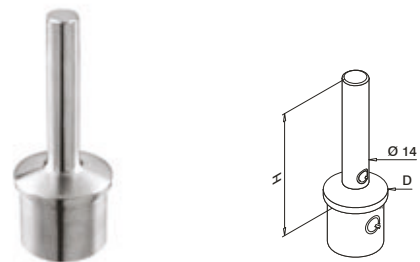
**MOD 0695****304**

INDOOR	D	H	
13.0695.200.12	42,4 x 2,0	79	2

316

OUTDOOR	D	H	
14.0695.200.12	42,4 x 2,0	79	2

MOD 0696**304**

INDOOR	D	H	
13.0696.200.12	48,3 x 2,0	80	2

316

OUTDOOR	D	H	
14.0696.200.12	48,3 x 2,0	80	2

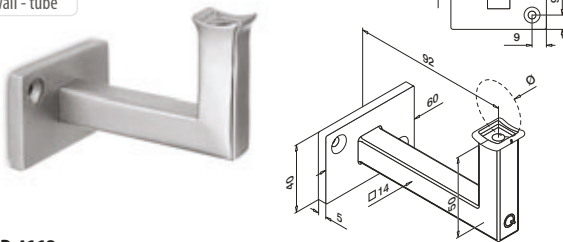

Wall - tube

**MOD 4112****304**

INDOOR	Ø		
13.4112.042.12	42,4	QS-7 302 / QS-25 303 / QS-87 305	2

**Q-INFO**

All products on this page will be delivered with satin surfaces and machined sides and edges.

Q-INFO**Q-23**

Q-cleaner
300 ml
19.0601.000.00

Q-INFO**Q-25****Q-22**

Q-ultra-clean
500 ml
19.0610.000.00

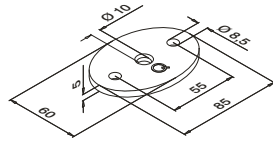
**MOD 1930****304****INDOOR**

13.1930.085.12

QS-3 302

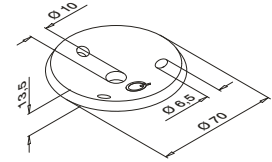

4

**MOD 1935****304****INDOOR**

13.1935.070.12

QS-56 302

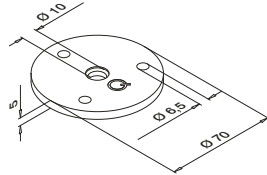

8

**MOD 1936****304****INDOOR**

13.1936.070.12

QS-56 302

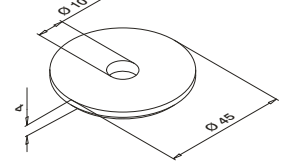
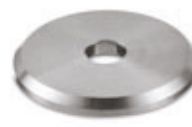

4

**MOD 1937****304****INDOOR**

13.1937.045.12

4

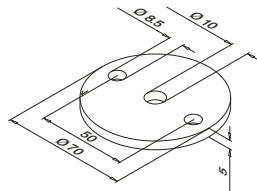
**MOD 1939****304****INDOOR**

13.1939.008.12

QS-3 302



8

**MOD 0813, 0814, 0815, 0816**

231

**MOD 1800**

195

**MOD 1801**

195

**MOD 1802**

195

Q-INFO

All products on this page will be delivered with satin surfaces and machined sides and edges.

Q-INFO**Q-23**

Q-cleaner

300 ml

19.0601.000.00

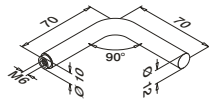

MOD 0813

304

INDOOR

13.0813.070.12



QS-14 303



2

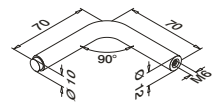

MOD 0814

304

INDOOR

13.0814.070.12



QS-14 303



2

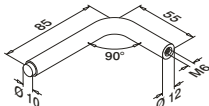

MOD 0814

304

INDOOR

13.0814.085.12



QS-14 303



2

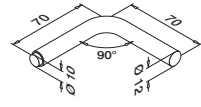

MOD 0815

304

INDOOR

13.0815.070.12



2

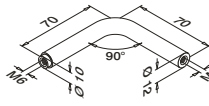

MOD 0816

304

INDOOR

13.0816.070.12



QS-14 303



2



MOD 1930

230



MOD 1935

230



MOD 1936

230



MOD 1800

195



MOD 1801

195



MOD 1802

195

Q-INFO

All products on this page will be delivered with satin surfaces and machined sides and edges.

Q-INFO MOD 0813

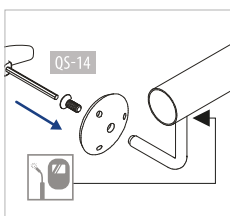

Q-INFO MOD 0814

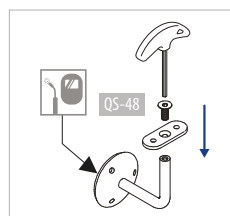

Q-INFO MOD 0815

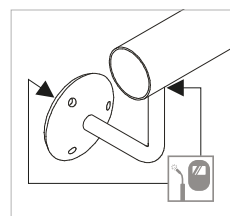

Q-INFO MOD 0816

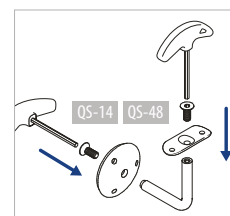

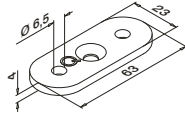
**MOD 1800****304****INDOOR**

13.1800.000.12	QS-48	303	QS-12	303	8
----------------	-------	-----	-------	-----	---

316**OUTDOOR**

14.1800.000.12	QS-89	303	QS-13	303	8
----------------	-------	-----	-------	-----	---

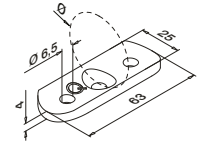
**MOD 1800****304****INDOOR**

13.1800.033.12	33,7	QS-48	303	QS-10	302	8
----------------	------	-------	-----	-------	-----	---

13.1800.042.12	42,4	QS-48	303	QS-10	302	8
----------------	------	-------	-----	-------	-----	---

13.1800.048.12	48,3	QS-48	303	QS-10	302	8
----------------	------	-------	-----	-------	-----	---

316**OUTDOOR**

14.1800.042.12	42,4	QS-89	303	QS-11	302	8
----------------	------	-------	-----	-------	-----	---

14.1800.048.12	48,3	QS-89	303	QS-11	302	8
----------------	------	-------	-----	-------	-----	---

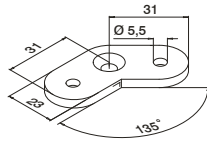
**MOD 1801****304****INDOOR**

13.1801.000.12	QS-48	303	QS-12	303	8
----------------	-------	-----	-------	-----	---

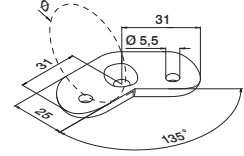
**MOD 1801****304****INDOOR**

13.1801.042.12	42,4	QS-48	303	QS-10	302	8
----------------	------	-------	-----	-------	-----	---

13.1801.048.12	48,3	QS-48	303	QS-10	302	8
----------------	------	-------	-----	-------	-----	---

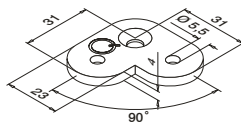
**MOD 1802****304****INDOOR**

13.1802.000.12	QS-48	303	QS-12	303	8
----------------	-------	-----	-------	-----	---

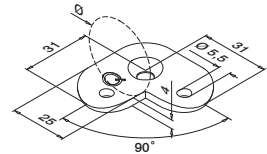
**MOD 1802****304****INDOOR**

13.1802.042.12	42,4	QS-48	303	QS-10	302	8
----------------	------	-------	-----	-------	-----	---

13.1802.048.12	48,3	QS-48	303	QS-10	302	8
----------------	------	-------	-----	-------	-----	---

**MOD 0811**
194**MOD 0812**
194**MOD 5735, 5736**
194**MOD 4811**
114**MOD 4733**
114**Q-INFO**

All products on this page will be delivered with satin surfaces and machined sides and edges.

Q-INFO**Q-23**

Q-cleaner

300 ml

19.0601.000.00

Q-INFO**Q-22**

Q-ultra-clean

500 ml

19.0610.000.00



Q-LIGHTS

Create atmosphere and add safety to stainless steel railings with Q-lights. This complete system includes everything needed to install a durable and long-lasting lighted railing with adjustable LED spotlights. Available in 24 V and 12 V versions, each LED spotlight is pre-wired to fit perfectly into the handrail using a unique click technology. Appropriate for both indoor and outdoor use, Q-lights can be installed in a $\varnothing 42,4$ or $\varnothing 48,3$ mm tube, and can therefore be used with any of our product lines when using a round handrail.

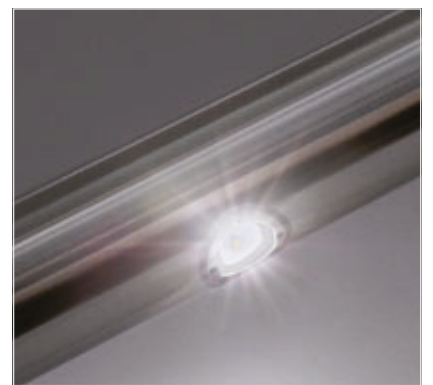

Q-LIGHTS - LED-spotlights - 12V



For tube 42,4 x 2,0 mm



Assymetric light beam
Colour temp 5000K
0,5W, 12V, 40mA
50.000 hours light

MOD 0051

INDOOR

41.0051.242.00



1

International Design Model Protection

For tube 48,3 x 2,0 mm



Assymetric light beam
Colour temp 5000K
0,5W, 12V, 40mA
50.000 hours light

MOD 0051

INDOOR

41.0051.248.00



1

International Design Model Protection

Q-INFO

Set: 41.0051.24x.12

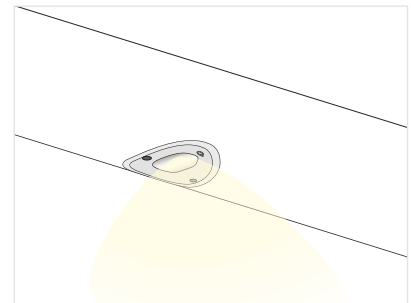
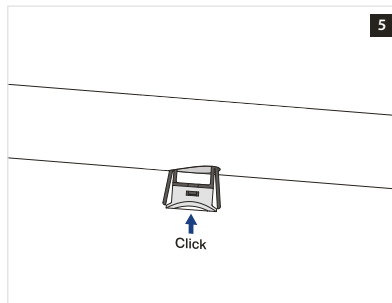
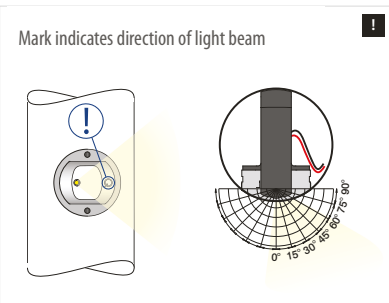
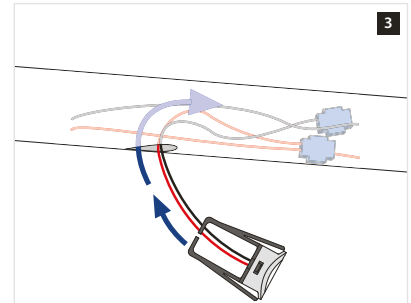
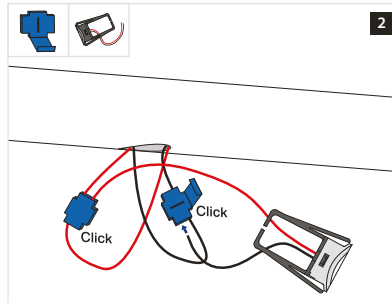
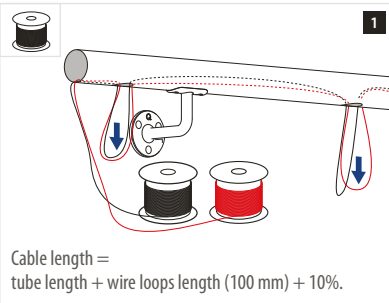
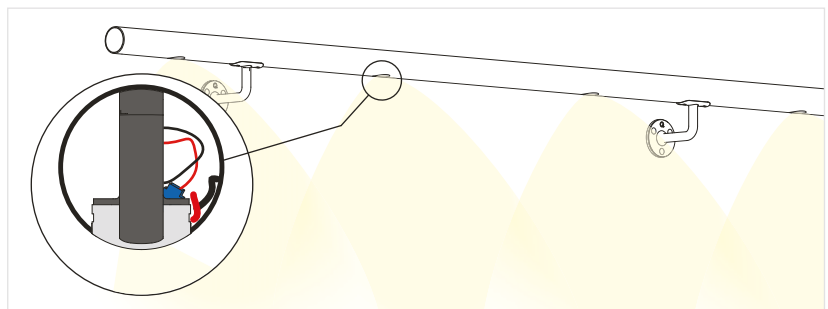
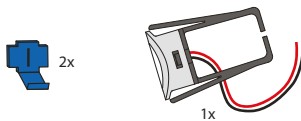

Q-INFO

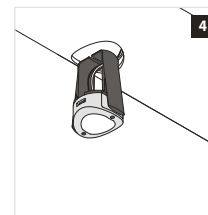
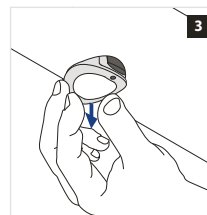
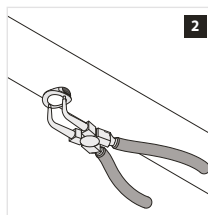
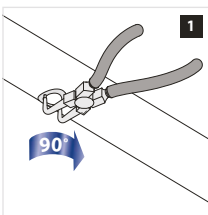

Safety information
237

Q-INFO

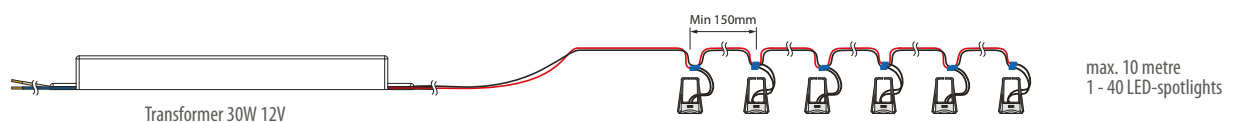

Q-LIGHTS - LED-spotlights - 24V

For tube 42,4 x 2,0 mm



Asymmetric light beam
Colour temp 5000K
500 mA LED driver
2W, 24V
50.000 hours light

MOD 0050

IN/OUTDOOR	
41.0050.242.12	1



Tubes 42,4 x 2,0 mm and 48,3 x 2,0 mm: see page 198.

For tube 48,3 x 2,0 mm



Asymmetric light beam
Colour temp 5000K
500 mA LED driver
2W, 24V
50.000 hours light

MOD 0050

IN/OUTDOOR	
41.0050.248.12	1



Prefix: see page 338.

LED-spotlight now also in bent tube. Contact us!

Q-INFO

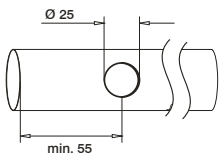

We recommend to mill the hole, if that is not possible a step drill should be used. Always debur drill holes and remove drilling remains to avoid cable breakage. Don't start installation of LED-spotlights until all holes have been deburred internally and externally.

Q-INFO

Short circuit and overheating protection

! The LED module is not protected for underwater usage. Please read all safety information on page 237.

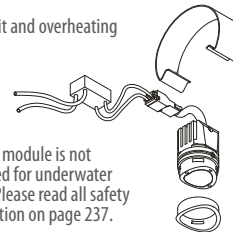

Unique click technology

Heat dissipation through heat sink

IP silicone seal body

Q-LIGHTS - LED-spotlights - Wiring layout

Q-INFO

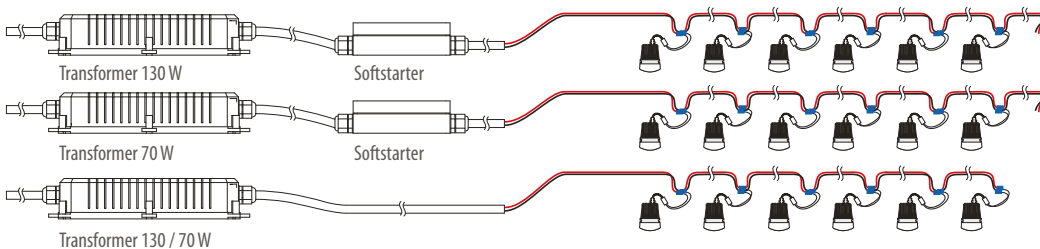

max. 26 metre
up to 52 LED-spotlights

max. 26 metre
up to 30 LED-spotlights

max. 26 metre
1 - 6 LED-spotlights

Transformer and Softstarter see page: 237

Q-LIGHTS - LED-spotlights - Disassembly

Q-INFO



Q-10 19.0706.000.00
Circlip pliers

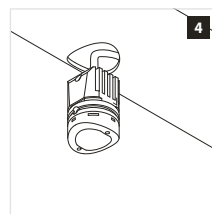
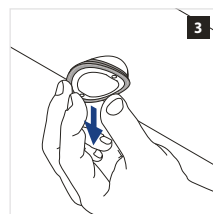
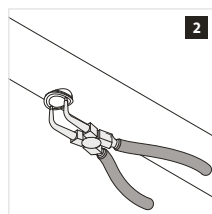
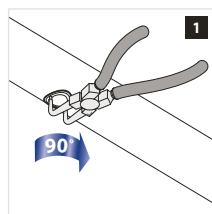

Q-LIGHTS - LED-spotlights - 24V - Assembly instruction

Q-INFO

Set: 41.0050.24x.12

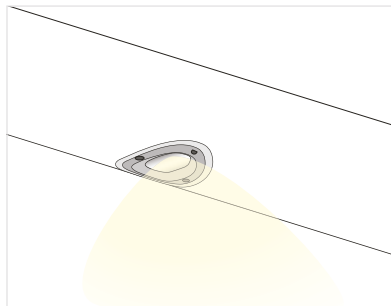
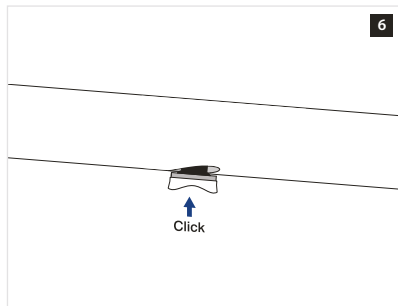
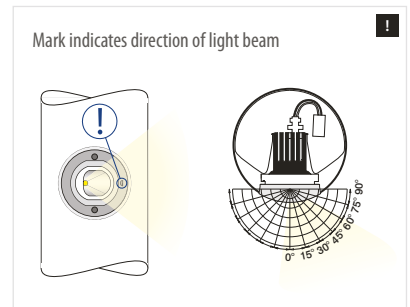
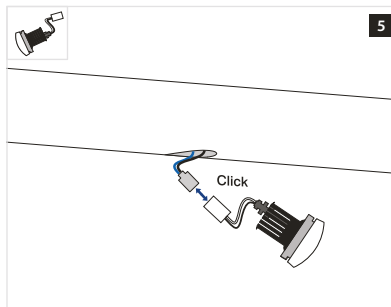
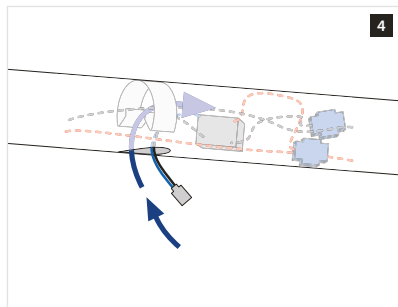
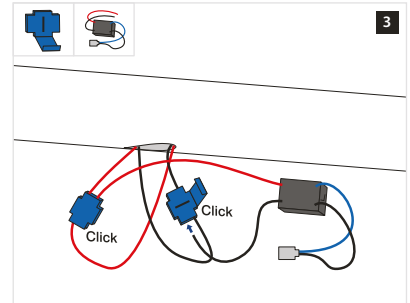
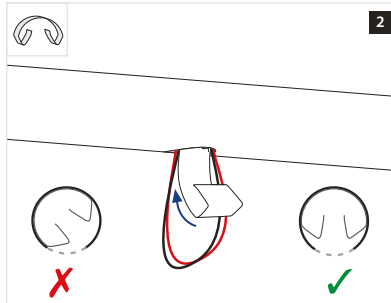
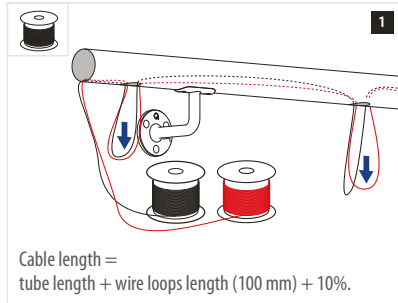
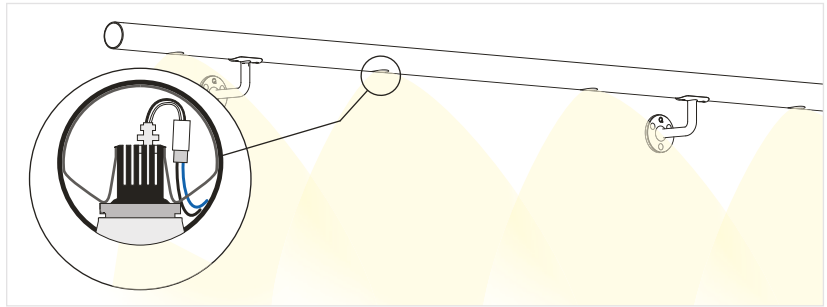
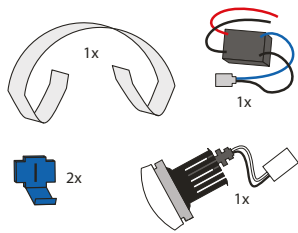

Q-INFO

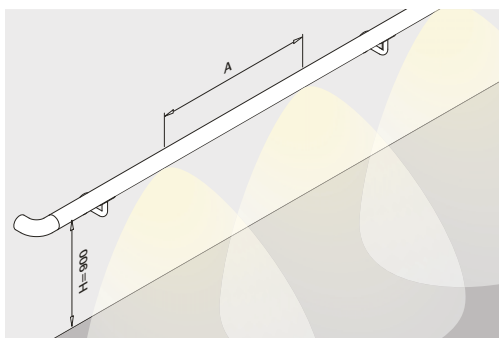

Q-railing recommends 600 mm distance between LED-spotlights to get the best luminous efficacy.

Luminous efficacy on floor/staircase of a 900 mm high handrail

	Distance (A) between LED-spotlights (mm)			
	400	600	1000	1200
Distance from wall (mm)				
0	241 lx	165 lx	98 lx	96 lx
600	200 lx	120 lx	80 lx	60 lx
1000	150 lx	80 lx	40 lx	40 lx
1500	100 lx	40 lx	20 lx	20 lx

Lux (lx) explanation
 direct sunlight = 100.000 lx
 overcast day, typical tv studio lighting = 1.000 lx
 hall lighting = 100 lx
 street lighting = 10 lx
 candle, approx. 1 m distant = 1 lx

Any lighting calculations shown should be taken as a guide only as all site conditions/lighting codes are different. It is strongly recommended that you consult with a Lighting Consultant or Electrical Engineer to determine the exact requirements for your project.

Q-LIGHTS - Connection technology

For MOD 50

Transformer 24V

220...240V~, CE, without plug

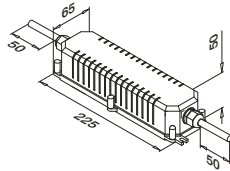

MOD 0011

IN/OUTDOOR	P	
19.0011.000.00	70W	1

MOD 0010

IN/OUTDOOR	P	
19.0010.000.00	130W	1



For MOD 50

Softstarter 24V

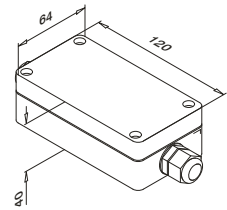

MOD 0010

IN/OUTDOOR	
19.0010.001.00	1



For MOD 51

Transformer 12V

220...240V~, CE, without plug

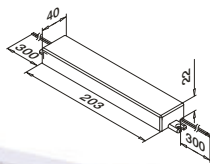

MOD 0013

INDOOR	P	
19.0013.000.00	70W	1



Black cable

Halogen-free, 1 mm², 145°C, for 12V and 24V, suitable for outdoor

MOD 0011

IN/OUTDOOR	
19.0011.050.00	L = 100 m



Red cable

Halogen-free, 1 mm², 145°C, for 12V and 24V, suitable for outdoor

MOD 0012

IN/OUTDOOR	
19.0012.050.00	L = 100 m

Q-INFO

SAFETY INFORMATION

- Installation of the mains modules has to be done by an authorized electrician according to the applicable local regulations and standards.
- Observe correct electrical polarity. Wrong polarity can destroy the modules.
- Only parallel drive circuits ensure a safe operation.
- Power supply units used for operation should ensure the following basic protection and safety features:
 - Short-Circuit Protection
 - Overload Protection
 - Overheat Protection
 - SELV (Safety Extra Low Voltage)
- Pay attention to the maximum output of the power supply.
- The 24 V LED module is not suitable for exposure to water. The 12 V LED module must not come into contact with water.
- Don't start installation of LED-spotlights until all holes have been deburred internally and externally.

Wall - tube

With cable duct

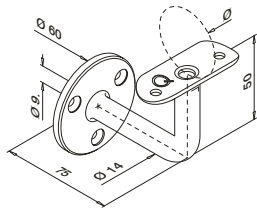

MOD 0103

304

INDOOR	Ø				
13.0103.042.12	42,4	QS-7	302 / QS-10	302	2
13.0103.048.12	48,3	QS-7	302 / QS-10	302	2

316

OUTDOOR	Ø				
14.0103.042.12	42,4	QS-50	302 / QS-11	302	2
14.0103.048.12	48,3	QS-50	302 / QS-11	302	2



Tube - tube

With cable duct

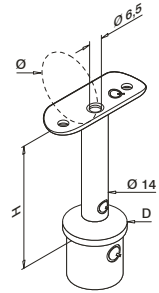

MOD 0710

316

OUTDOOR	D	Ø	H			
14.0710.642.12	42,4 x 2,0	42,4	79	QS-11	302	2

MOD 0711

316

OUTDOOR	D	Ø	H			
14.0711.648.12	48,3 x 2,0	48,3	80	QS-11	302	2



Q-INFO MOD 0103

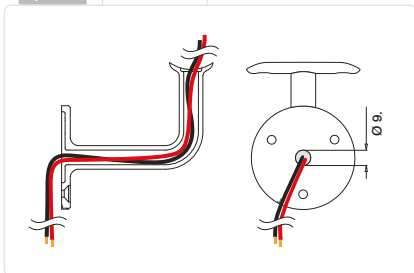

Q-INFO MOD 0710.6xx

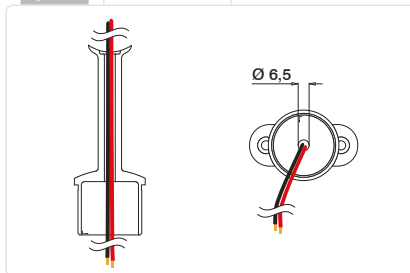

Q-INFO



Q-INFO MOD 0103

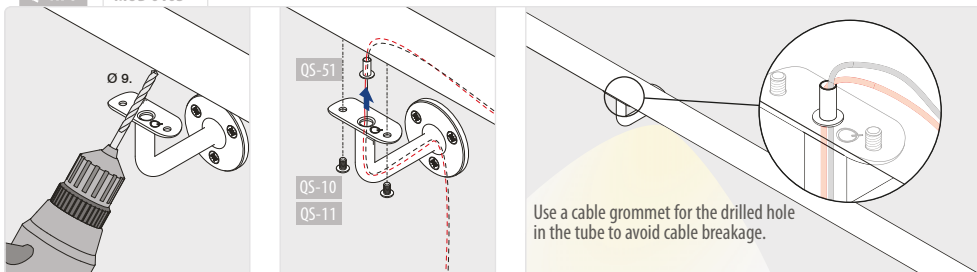

Use a cable grommet for the drilled hole in the tube to avoid cable breakage.

Q-INFO MOD 0103/0710

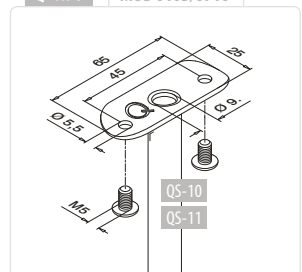

Handrails

SATIN

Q-LINE - Handrail adapters

Tube - tube

With cable duct

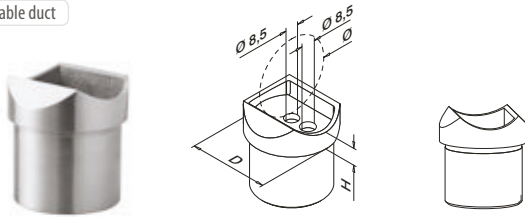

MOD 0772 - D = Ø 42,4 mm

304

INDOOR	D	Ø	H	Accessories	Qty
13.0772.242.12	Ø 42,4 x 2,0	42,4	9	QS-26 303	2

316

OUTDOOR	D	Ø	H	Accessories	Qty
14.0772.242.12	Ø 42,4 x 2,0	42,4	9	QS-27 303	2

MOD 0771 - D = Ø 48,3 mm

304

INDOOR	D	Ø	H	Accessories	Qty
13.0771.248.12	Ø 48,3 x 2,0	48,3	11	QS-26 303	2

316

OUTDOOR	D	Ø	H	Accessories	Qty
14.0771.248.12	Ø 48,3 x 2,0	48,3	11	QS-27 303	2



MOD 0914
130

MOD 0512
142

Handrails

SATIN

Q-LINE - Connectors, adjustable

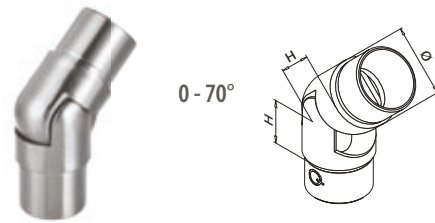

MOD 0312

304

INDOOR	Ø	H	Qty
13.0312.242.12	42,4 x 2,0	27	2
13.0312.248.12	48,3 x 2,0	30	2

316

OUTDOOR	Ø	H	Qty
14.0312.242.12	42,4 x 2,0	27	2
14.0312.248.12	48,3 x 2,0	30	2

DESIGN
product

International Design Model Protection

Handrails

SATIN

Q-LINE - End pieces

Wall - tube

With cable duct

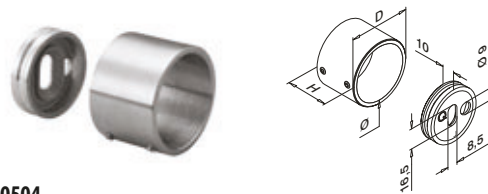

MOD 0504

304

INDOOR	Ø	D	H	Accessories	Qty
13.0504.042.12	42,4	50	35	QS-55 305 / QS-21 303	2
13.0504.048.12	48,3	56	35	QS-55 305 / QS-21 303	2

316

OUTDOOR	Ø	D	H	Accessories	Qty
14.0504.042.12	42,4	50	35	QS-55 305 / QS-22 303	2
14.0504.048.12	48,3	56	35	QS-55 305 / QS-22 303	2



Q-INFO MOD 0772 / 0771

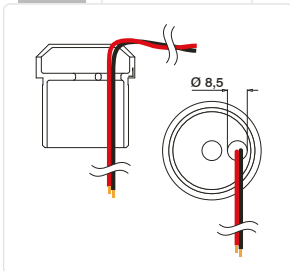

Q-INFO MOD 0312

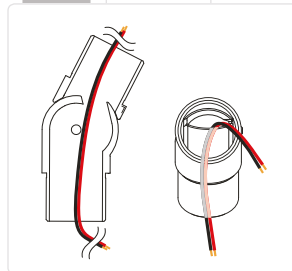

Q-INFO MOD 0772 / 0771

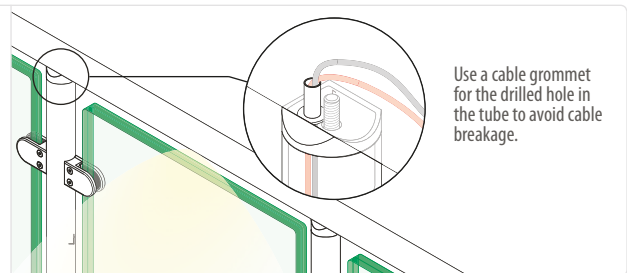
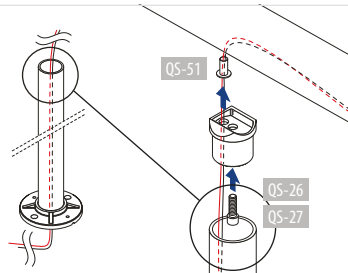
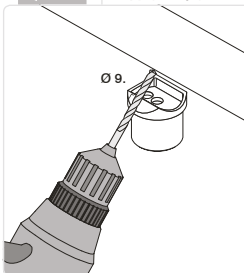

Q-INFO MOD 0504

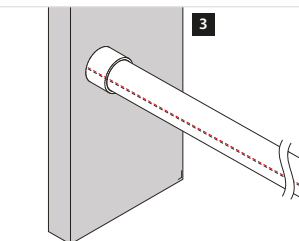
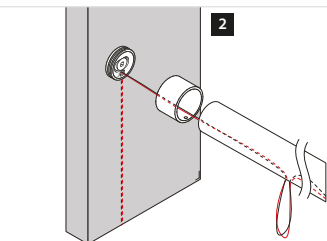
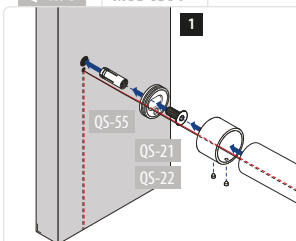

Q-INFO MOD 0504

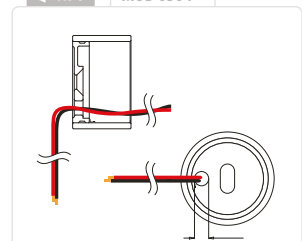



BENDYWOOD

Q-railing's Bendywood gives you the ability to easily bend a wooden handrail by hand or with a simple pipe bending machine -without using water, heat or chemicals. A complete bend takes only 10 minutes and rebending is always possible. The high-grade Bendywood solid wood can be processed as normal with adhesive, drills, screws, etc. and can be sawed, sanded and stained.

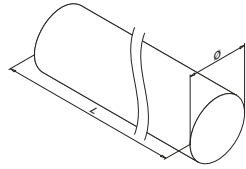

**MOD 8925 / 0900** - Beech, untreated wood

Ø 42 mm

Wood

INDOOR	Ø	
21.8925.042.39	42,0	L = 3600 mm
21.0900.042.39	42,0	L = 6600 mm



Q-INFO

Assembly instruction

Thank you for choosing Q-bendwood. You have decided to use an innovative, high quality product that gives you the possibility to create any profile that you can dream of with the ease of simple woodwork.

Although handling Q-bendwood is very easy, we would like to ask you to read the technical information and consider them with mounting. Please visit www.q-railing.com for further Q-bendwood information and references.

General information

Q-bendwood handrail can be bent up to a radius that is 30 times the thickness of the handrail (e.g. a 42mm handrail can be bent up to a radius of 1260mm). Since Q-bendwood is a natural product, manufacturing of the minimum radius are possible.

Ø12 R_{min} 42x3mm

Ø16 R_{min} 42x5mm

The spacing at which the handrail will be mounted on should be stable. The ideal distance between the fixing points is approximately 1 meter.

Please take care that when using Q-bendwood handrails made of soft wood, they do not get in contact with metal. Use wood contact protect which can cause discoloration. Check coating when it gets in contact to metal.

Before handling

Please leave the Q-bendwood handrails in their original packaging until handling.

Handling by hand

Q-bendwood can be bent directly after unpacking. Please do not bend handrails into different directions for better work.

- We recommend the use of 2 people to bend Q-bendwood, while this is an easy process the use of 2 people will ease the handling and installation process. The handrail can be bent on a template or directly on the railing that it will be mounted on (the railing has to be stable enough). We recommend the use of Q-bendwood for handrails on following stairs.
- Please bend the handrail from the bottom to the top there an overlength of fibres should be arranged and be in proximity with the help of cable ties at every stair respectively every post of the railing.



Please refer to the installation instructions supplied with the product.

Wood is a natural product. Colours can differ.

Q-INFO

Max. 50% radius (R)

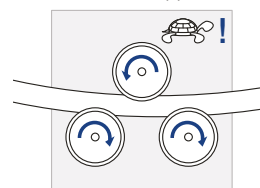
Ø 42 R_{min} : 840 mm

If kept in their packaging, manipulation is possible for four months after delivery.

Q-INFO

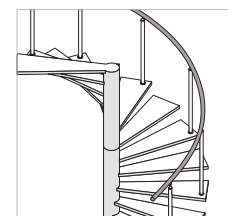
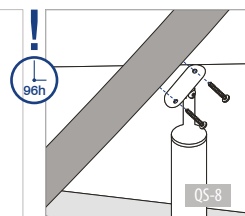
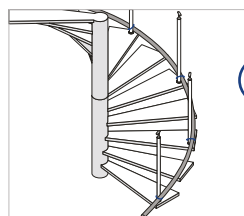
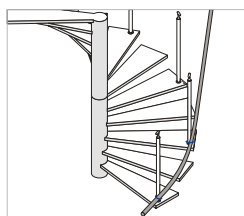
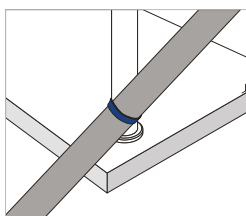



NATURAIL

THE NATURAL ALTERNATIVE BY Q-RAILING

Wooden handrails, connectors and end fittings, the perfect alternative for those who want to add a touch of nature to their stainless steel railing system.

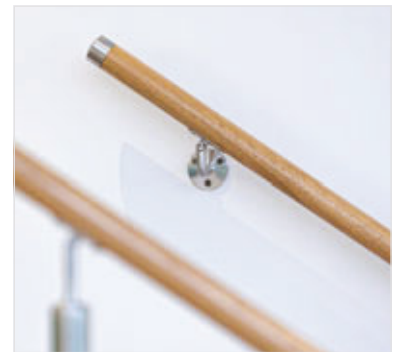

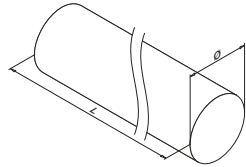

MOD 8925 - Beech, untreated wood

Wood			
INDOOR	Ø		
20.8925.042.39	42,0		L = 2500 mm

Wood			
INDOOR	Ø		
20.8925.048.39	48,0		L = 2500 mm

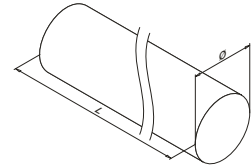

MOD 8925 - Cedar, untreated wood

Wood			
OUTDOOR	Ø		
20.8925.042.45	42,0		L = 2500 mm

NATURAIL - Accessories

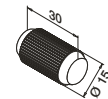

MOD 0203

Wood			
INDOOR	QS		
20.0203.015.39	QS-512		50



Wood glue

PVAC glue for wooden bonding applications

MOD 1335

Accessories			
	Q	e	
19.1335.000.00	Q-73	250 ml	1



Mounting tool

MOD 0709

Accessories			
	Q	Ø	
19.0709.000.35	Q-82	42,0 + 48,0	1



Drillbit with stopper

for wood

MOD 0708

Accessories			
	Q	Ø	
19.0708.015.00	Q-80	15	1

Wood is a natural product. Colours can differ.

Q-INFO

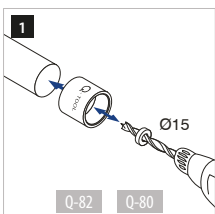

Q-73
Wood glue
250 ml
19.1335.000.00

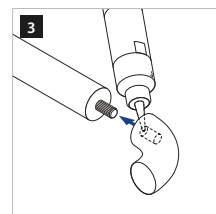
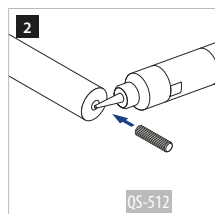

Q-INFO

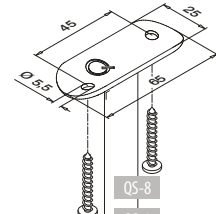

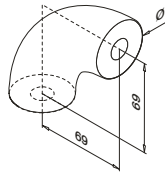
**MOD 0305** - Beech, untreated wood

Wood		
INDOOR	Ø	
20.0305.042.39	42,0	2

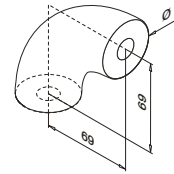
**MOD 0305** - Beech, lacquered

Wood		
INDOOR	Ø	
20.0305.042.40	42,0	2

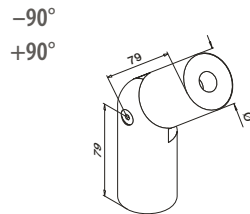
**MOD 0302** - Beech, untreated wood

Wood		
INDOOR	Ø	
20.0302.042.39	42,0	2

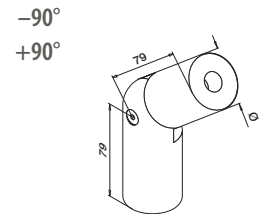
**MOD 0302** - Beech, lacquered

Wood		
INDOOR	Ø	
20.0302.042.40	42,0	2

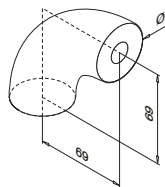
**MOD 0739** - Beech, untreated wood

Wood		
INDOOR	Ø	
20.0739.042.39	42,0	2

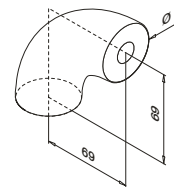
**MOD 0739** - Beech, lacquered

Wood		
INDOOR	Ø	
20.0739.042.40	42,0	2

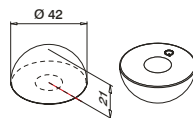
**MOD 0729** - Beech, untreated wood

Wood		
INDOOR	Ø	
20.0729.042.39	42,0	2

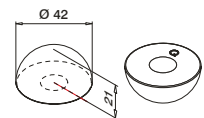
**MOD 0729** - Beech, lacquered

Wood		
INDOOR	Ø	
20.0729.042.40	42,0	2



Wood is a natural product. Colours can differ.

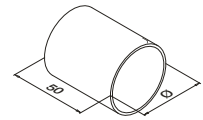
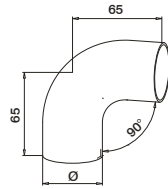

MOD 0305

304

INDOOR	Ø		
20.0305.042.12	42,0	QS-7	2
20.0305.048.12	48,0	QS-7	2

316

OUTDOOR	Ø		
22.0305.042.12	42,0	QS-50	2



Not suitable with MOD 0710 and 0810 (handrailing brackets)

MOD 0790

304

INDOOR	Ø		
20.0790.042.12	42,0	QS-7	2
20.0790.048.12	48,0	QS-7	2

316

OUTDOOR	Ø		
22.0790.042.12	42,0	QS-50	2

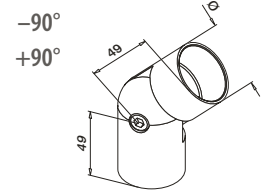
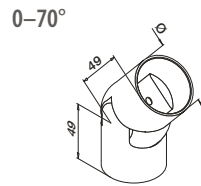

MOD 0312

304

INDOOR	Ø		
20.0312.042.12	42,0	QS-7	2
20.0312.048.12	48,0	QS-7	2

316

OUTDOOR	Ø		
22.0312.042.12	42,0	QS-50	2



MOD 0302

304

INDOOR	Ø		
20.0302.042.12	42,0	QS-7	2



Q-INFO

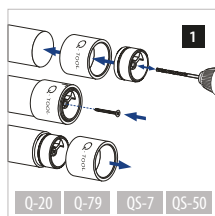
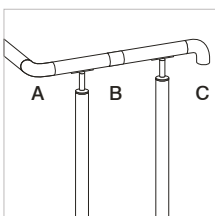

Q-21
Q-glue
50 ml
19.1331.000.00

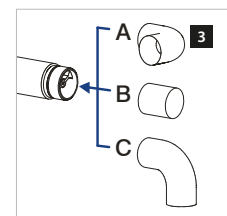
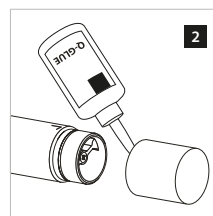



MOD 0729

304

INDOOR	Ø		
20.0729.042.12	42,0	QS-7	302 2
20.0729.048.12	48,0	QS-7	302 2

316

OUTDOOR	Ø		
22.0729.042.12	42,0	QS-50	302 2



MOD 0739

304

INDOOR	Ø		
20.0739.042.12	42,0	QS-7	302 2
20.0739.048.12	48,0	QS-7	302 2

316

OUTDOOR	Ø		
22.0739.042.12	42,0	QS-50	302 2



MOD 0792

304

INDOOR	Ø		
20.0792.042.00	42,0	QS-7	302 2

316

OUTDOOR	Ø		
22.0792.042.00	42,0	QS-50	302 2



Mounting tool

MOD 0710

	Q	Ø	
19.0710.042.12	Q-20	Ø 42	1
19.0710.048.12	Q-79	Ø 48	1

Q-INFO

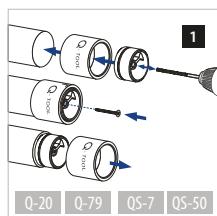
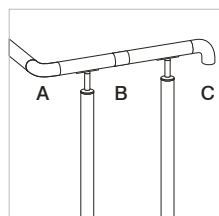

Q-21
Q-glue
50 ml
19.1331.000.00

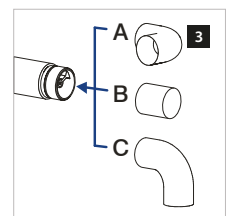
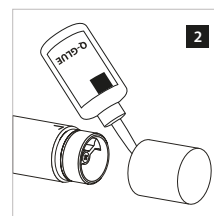



ULTRA RANGE

HIGH-PERFORMANCE ULTRA RANGE: OUTSTANDING RESISTANCE GUARANTEED

Our Ultra Range provides products of unmatched quality, with extra resistance to tea-staining and pitting. Thanks to durable, corrosion-resistant materials, this range is ideal for swimming pools and coastal areas alike. In fact, we're so confident in the Ultra Range's high performance that we offer a 2 year warranty, quality guaranteed.*

* Corrosion-free guarantee for 2 years, subject to terms and conditions.

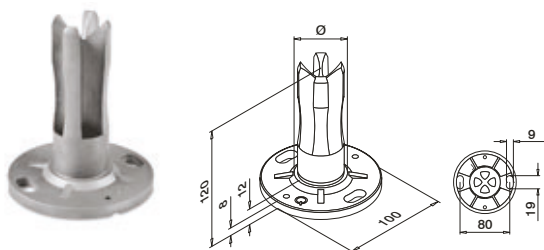

**MOD 0942**

2205

OUTDOOR

18.0942.242.00	42,4 x 2,0	Q5-500 306	2
----------------	------------	------------	---

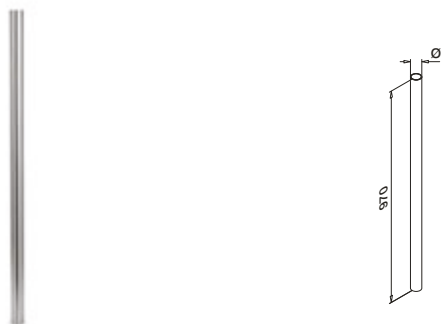

International Design Model Protection

**MOD 3901**

2205

OUTDOOR

18.3901.242.12	42,4 x 2,0		1
----------------	------------	--	---

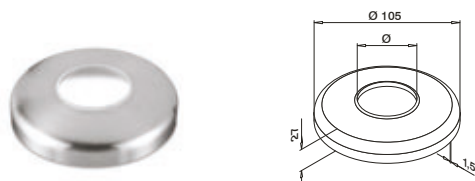
**MOD 0510**

2205

OUTDOOR

18.0510.042.12	42,4		2
----------------	------	--	---

Q-INFO

MOD 0942

1



Q-21
Q-gluе, 50 ml
19.1331.000.00

2

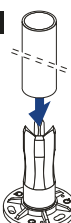

3

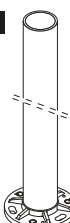

Q-INFO



Q-22

Q-ultra-clean
500 ml
19.0610.000.00



Tube



Ø 42,4

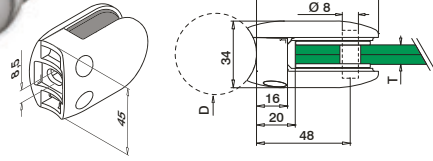

MOD 28

2205



OUTDOOR	D	T	
18.2806.042.12	42,4	6	4
18.2808.042.12	42,4	8	4
18.2810.042.12	42,4	10	4
18.2812.042.12	42,4	12	4

2205



OUTDOOR	D	T	
18.2807.042.12	42,4	6,76 (3 - 0,76 - 3)	4
18.2841.042.12	42,4	8,38 (4 - 0,38 - 4)	4
18.2809.042.12	42,4	8,76 (4 - 0,76 - 4)	4
18.2844.042.12	42,4	9,52 (4 - 1,52 - 4)	4
18.2811.042.12	42,4	10,76 (5 - 0,76 - 5)	4
18.2854.042.12	42,4	11,52 (5 - 1,52 - 5)	4
18.2813.042.12	42,4	12,76 (6 - 0,76 - 6)	4

DESIGN
product

International Design Model Protection

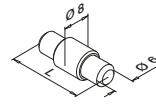
Security pins for glass clamps,
optional use for model 28

MOD 5015

2205

OUTDOOR	For MOD	L	
19.5015.022.18	MOD 28	22	4

Q-INFO

MOD 5015

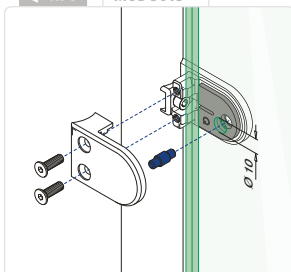

Q-INFO



Please order security pins and fixing bolts separately.

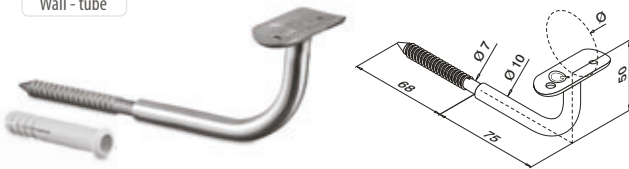

Wall - tube

**MOD 0110**

2205		
OUTDOOR	Ø	
18.0110.042.12	42,4	2

**MOD 0509**

2205		
OUTDOOR		
18.0509.012.12		2

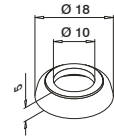

Wall - tube

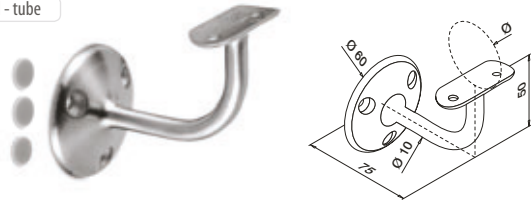
**MOD 0116**

2205		
OUTDOOR	Ø	
18.0116.042.12	42,4	2

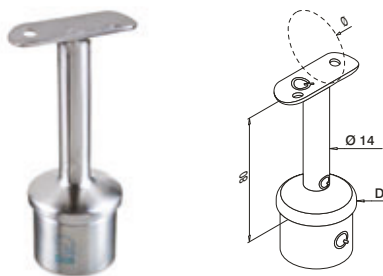

Tube - tube

**MOD 0690**

2205	D	Ø	
18.0690.242.12	42,4 x 2,0	42,4	2

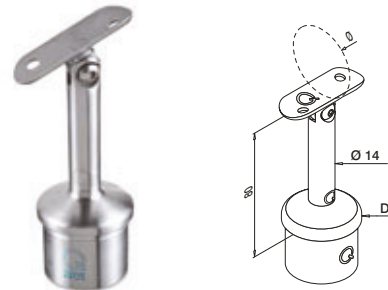

Tube - tube

**MOD 0698**

2205	D	Ø	
18.0698.242.12	42,4 x 2,0	42,4	2



Q-INFO

MOD 0690 / 0698

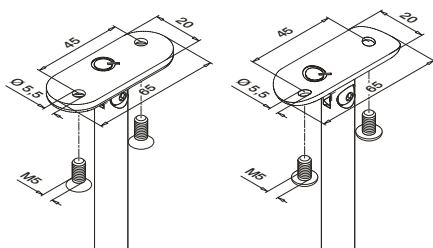

Q-INFO



Q-23
Q-cleaner
300 ml
19.0601.000.00

Q-INFO



Q-22
Q-ultra-clean
500 ml
19.0610.000.00

Q-INFO

MOD 0110 / 0509

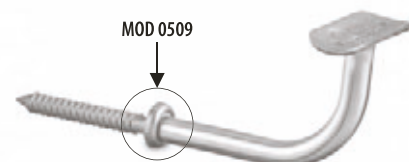

2205= low nickel content



Tube - tube

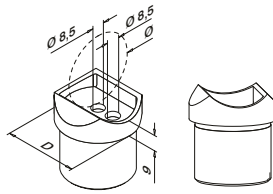

MOD 0772

2205

OUTDOOR

	D	Ø	
18.0772.242.12	Ø 42,4 x 2,0	42,4	2



Tube - tube



0-70°

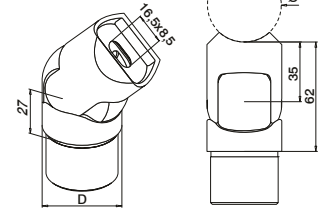

MOD 0776

2205

OUTDOOR

	D	Ø	
18.0776.242.12	Ø 42,4 x 2,0	42,4	2



Q-TUBE

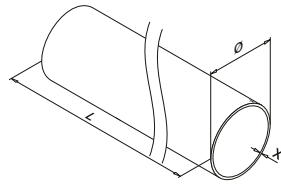

MOD 8925 / 0900

2205

OUTDOOR

	Ø	X	
18.8925.242.12	42,4	2,0	L = 2500 mm
18.0900.242.12	42,4	2,0	L = 5000 mm



Q-INFO

MOD 0772

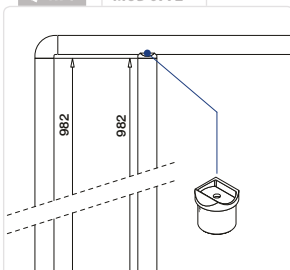

Q-INFO

MOD 0776

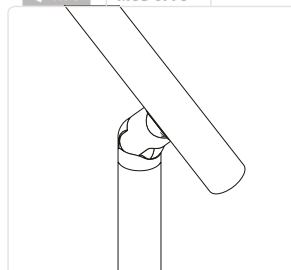

Q-INFO

MOD 8925 / 0900

Calculation basis for tubes

calculated by **ONDRA**

	Ø (mm)	A (cm ²)	I _x (cm ⁴)	I _y (cm ⁴)	W _x (cm ³)	W _y (cm ³)	M (kg/m)	R _{p0,2} (kN/cm ²)	R _m (kN/cm ²)
18.0900.242.12	42,4	2,58	2,80	5,11	1,66	2,41	2,02	48	66
18.8925.242.12									

A = cross sectional area
I_x / I_y = second moment of area
W_x / W_y = section modulus

M = weight
R_{p0,2} = permissible stress
R_m = minimum tensile strength

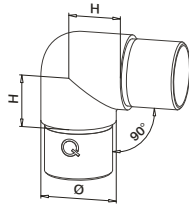
**MOD 0303**

2205

OUTDOOR	Ø	H	
18.0303.242.12	42,4 x 2,0	30	2

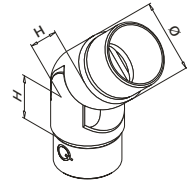

0 - 70°

**MOD 0312**

2205

OUTDOOR	Ø	H	
18.0312.242.12	42,4 x 2,0	27	2

DESIGN
product

International Design Model Protection

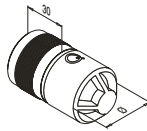
**MOD 5792 - EASY HIT®**

2205

OUTDOOR	Ø	
18.5792.242.00	for 42,4 x 2,0	2

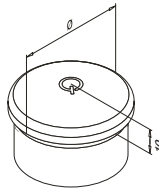

International Design Model Protection

**MOD 0730**

2205

OUTDOOR	Ø	
18.0730.242.12	42,4 x 2,0	2



Q-INFO

MOD 5792

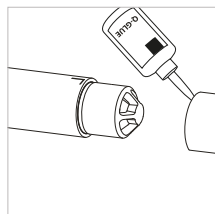
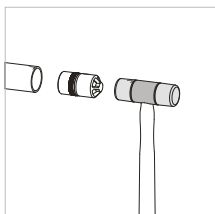

Q-21
Q-glue
50 ml
19.1331.000.00

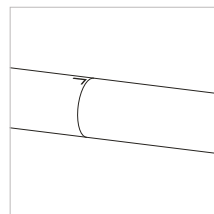

Q-INFO



Q-22
Q-ultra-clean
500 ml
19.0610.000.00



GLASS INFILL
HOLDERS

3

CREATE THE MOST BEAUTIFUL BALUSTRADES USING A COMBINATION OF GLASS AND STEEL

Sleek but safe, safe, safe. BS- DIN EN 12600 approved.

If you're combining glass and steel, you can choose from our wide range of glass fixings, with options available to fit every railing project imaginable. From brushed or polished stainless steel to raw uncoated zintec or matt chromium-plated and powder-coated zintec, our designs and coatings give a sleek and unique finish.

Of course, regardless of how attractive they are, the primary purpose of railings is safety. We're committed to meeting all of the stringent requirements and legislation in our field for every product we sell. Our professional glass clamp system, for example, is secure as well as great looking. We care about safety and that's one of the reasons why thousands of professionals choose Q-railing every day.

Glass clamps: safety first!

It goes without saying that balustrades that are partly composed of glass must never be allowed to break, even under the most extreme strain such as a dynamic force of 50 kg (DIN/EN12600 standard). Q-railing's glass clamps for both mono and laminated glass from 8 mm to 17,52 mm have been tested and approved to this level.

On the basis of the DIN/EN 12600 standard, our glass clamps have also been approved by the DIBt and obtained the German AbZ, the highest-level federal bureau for supervision in construction. The indoor tests were carried out by the Technical University of Munich, the outdoor tests by the Engineering consultancy of Dr. Roland Ondra and the LGA in Wurzburg. The test results on the following pages will provide you with a clear guideline of which glass clamps you should use for the glass panels in question.

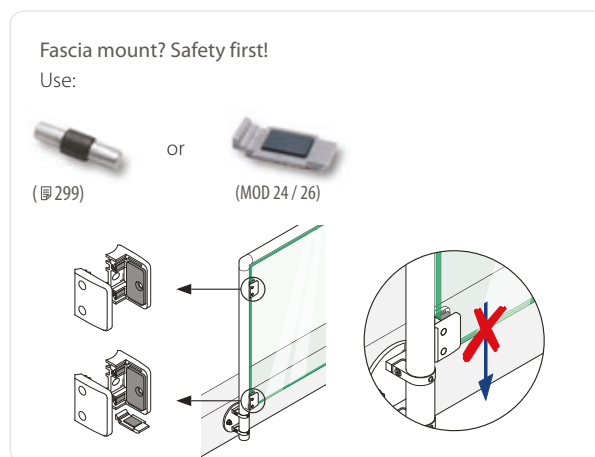
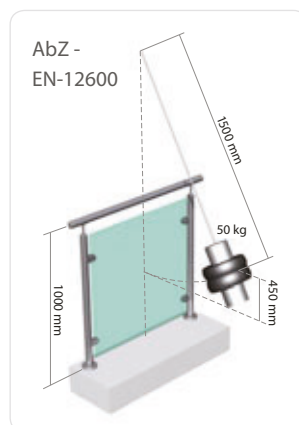

INDEX

GLASS INFILL HOLDERS



▣ 260 - 284
Glass clamps



▣ 285
Glass holders



▣ 287
Glass connectors



▣ 288 - 289
Hinges and door locks



▣ 290 - 292
Glass adapters
Spider



▣ 294
Glass adapters
Ø 25 mm



▣ 293
Glass adapters
Ø 30 mm



▣ 294
Glass adapters
Ø 50 mm

Glass clamps

		Glass thickness (mm)				Glass thickness (mm)								
MOD 20	▣ 260	6	8			6,76								
MOD 21	▣ 262	6	8	10		6,76	8,76	9,52						
MOD 22	▣ 264	6	8	10		6,76	8,38	8,76	9,52					
MOD 24	▣ 266			12	15			9,52		11,52	12,76	13,52	16,76	17,52
MOD 25	▣ 268			12						10,76	11,52	12,76		
MOD 26	▣ 272	MONO	8	10	12	LAM.		8,76	9,52	10,76	11,52	12,76		
MOD 27	▣ 274	MONO		10		LAM.		8,76	9,52	10,76				
MOD 28	▣ 278		6	8	10	12		6,76	8,38	8,76	9,52	10,76	11,52	12,76
MOD 29	▣ 282			8	10	12			8,76	9,52	10,76	11,52	12,76	13,52
MOD 44/46	▣ 280			8	10	12			8,76		10,76		12,76	
MOD 51/52	▣ 284			8	10	12			8,76		10,76		12,76	
MOD 55	▣ 285			8	10	12			8,76	9,52	10,76	11,52	12,76	13,52

Glass connectors

		Glass thickness (mm)				Glass thickness (mm)								
MOD 22	▣ 287	MONO	6	8	10	LAM.	6,76	8,38	8,76	9,52				

Hinges and door locks

		Glass thickness (mm)				Glass thickness (mm)								
MOD 0281	▣ 288	MONO	6	8	10	12	LAM.	6,76	8,38	8,76	9,52	10,76	11,52	12,76
MOD 0282	▣ 288	MONO	6	8	10	12	LAM.	6,76	8,38	8,76	9,52	10,76	11,52	12,76

Glass adapters Ø 50 mm

		Glass thickness (mm)				Glass thickness (mm)											
MOD 4752	▣ 290		8	10	12		8,38	8,76	9,52	10,76	11,52	12,76	13,52				
MOD 4753	▣ 290		8	10	12		8,38	8,76	9,52	10,76	11,52	12,76	13,52				
MOD 0750	▣ 291		8	10	12		8,38	8,76	9,52	10,76	11,52	12,76	13,52				
MOD 0751	▣ 291		8	10	12		8,38	8,76	9,52	10,76	11,52	12,76	13,52				
MOD 0752	▣ 291	MONO	8	10	12	LAM.	8,38	8,76	9,52	10,76	11,52	12,76	13,52				
MOD 0753	▣ 291		8	10	12		8,38	8,76	9,52	10,76	11,52	12,76	13,52				
MOD 0754	▣ 292		8	10	12	15	16	8,38	8,76	9,52	10,76	11,52	12,76	13,52			
MOD 0746 (Ø 25)	▣ 294		6	8	10	12		6,76	8,38	8,76	9,52	10,76	11,52				
MOD 0746 (Ø 30)	▣ 293		6	8	10	12	15	16	6,76	8,38	8,76	9,52	10,76	11,52	12,76	13,52	
MOD 0747 (Ø 50)	▣ 294		8	10	12	15	16	18	8,38	8,76	9,52	10,76	11,52	12,76	13,52	16,76	17,52

Glass clamps - EN-12600 - Test results (top mount)

MOD 20 / 21 / 22 / 24 / 25 / 26 Test setup

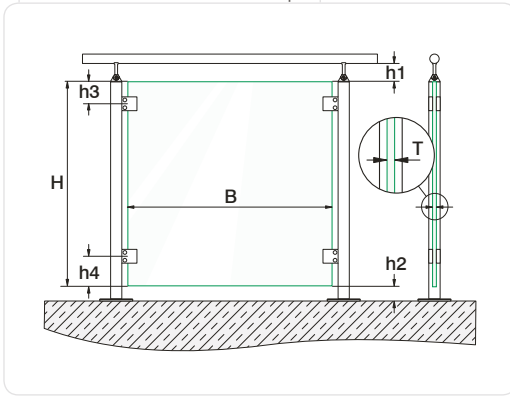

Dimensions (mm)		min.	max.
B	Glass width	500	See table
T	Glass thickness	See table	See table
H	Glass height	800	1000
h1	Handrail - top glass panel	10	50 without edge protection 120 with edge protection
h2	Floor - base glass panel	10	50 without edge protection 120 with edge protection
h3	Top glass panel - upper glass clamp	100	150
h4	Lower glass clamp - base glass panel	100	150

INDOOR

Glass clamps without security pin and without security plate.

MOD 20

Zinc

316

Flat or tube
Ø 33,7 mm
Ø 42,4 mm

Glass type	Mono / ESG-H*
T (mm)	8
W _{max} (mm)	500 - 1200

MOD 21

Zinc

316

Flat or tube
Ø 42,4 mm

Glass type	VSG / ESG*	
T (mm)	8,76	9,52
W _{max} (mm)	500 - 1200	500 - 1200

MOD 22

Zinc

316

Flat or tube
Ø 42,4 mm
Ø 48,3 mm

Glass type	VSG / TVG*		VSG / ESG*		Mono / ESG-H*	
T (mm)	8,76	9,52	8,76	9,52	8	10
W _{max} (mm)	500 - 1500	500 - 1500	500 - 1500	500 - 1500	500 - 1500	500 - 1500

MOD 24

Zinc

316

Flat or tube
Ø 42,4 mm
Ø 48,3 mm

Glass type	VSG / SPG*				VSG / TVG*				VSG / ESG*				Mono / ESG-H*	
T (mm)	12,76	13,52	16,76	17,52	12,76	13,52	16,76	17,52	12,76	13,52	16,76	17,52	12	16
W _{max} (mm)	500 - 1500	500 - 1500	500 - 1500	500 - 1500	500 - 1500	500 - 1500	500 - 1500	500 - 1500	500 - 1600	500 - 1600	500 - 1600	500 - 1600	500 - 1600	500 - 1600

MOD 25

Zinc

316

Flat or tube
Ø 42,4 mm
Ø 48,3 mm

Glass type	VSG / TVG*			VSG / ESG*			Mono / ESG-H*
T (mm)	10,76	11,52	12,76	10,76	11,52	12,76	12
W _{max} (mm)	500 - 1500	500 - 1500	500 - 1500	500 - 1500	500 - 1500	500 - 1500	500 - 1500

MOD 26

Zinc

316

Flat or tube
Ø 42,4 mm
Ø 48,3 mm

Glass type	VSG / TVG*					VSG / ESG*					Mono / ESG-H*		
T (mm)	8,76	9,52	10,76	11,52	12,76	8,76	9,52	10,76	11,52	12,76	8	10	12
W _{max} (mm)	500 - 1400	500 - 1400	500 - 1600	500 - 1600	500 - 1600	500 - 1400	500 - 1400	500 - 1600	500 - 1600	500 - 1600	500 - 1400	500 - 1600	500 - 1600

* VSG: Laminated glass
Mono: Single Panel glassSPG: Float/Annealed glass
TVG: Heat strengthened glassESG: Toughened glass
ESG-H: Heat Soaked Toughened glass



OUTDOOR

Possible glass width for outdoor use depending on wind factor, glass type and glass thickness without security pin and without security plate.

MOD 22

316



Flat or tube
Ø 42,4 mm
Ø 48,3 mm

F (Force)	Glass type	VSG / TVG*		VSG / ESG*		Mono / ESG-H*	
	T (mm)	8,76	9,52	8,76	9,52	8	10
2,20 kN/m ²	W _{max} (mm)					800	800
1,60 kN/m ²				500	500	1000	1400
1,40 kN/m ²				500	500	1000	1400
1,04 kN/m ²		500	500	800	800	1400	1500
1,00 kN/m ²		500	500	1000	1000	1400	1500
0,64 kN/m ²		800	800	1200	1200	1500	1500

MOD 24

316



Flat or tube
Ø 48,3 mm

F (Force)	Glass type	VSG / SPG*				VSG / TVG*				VSG / ESG*				Mono / ESG-H*	
	T (mm)	12,76	13,52	16,76	17,52	12,76	13,52	16,76	17,52	12,76	13,52	16,76	17,52	12	16
2,20 kN/m ²	W _{max} (mm)	500	500	800	800	500	500	1000	1000	1000	1000	1200	1200	1400	1600
1,60 kN/m ²		500	500	1000	1000	800	800	1200	1200	1200	1200	1500	1500	1600	1600
1,40 kN/m ²		800	800	1000	1000	800	800	1200	1200	1200	1200	1600	1600	1600	1600
1,04 kN/m ²		800	800	1200	1200	1000	1000	1500	1500	1400	1400	1600	1600	1600	1600
1,00 kN/m ²		1000	1000	1200	1200	1000	1000	1500	1500	1500	1500	1600	1600	1600	1600
0,64 kN/m ²		1200	1200	1500	1500	1500	1500	1500	1500	1600	1600	1600	1600	1600	1600

MOD 25

316



Flat or tube
Ø 42,4 mm
Ø 48,3 mm

F (Force)	Glass type	VSG / TVG*			VSG / ESG*			Mono / ESG-H*
	T (mm)	10,76	11,52	12,76	10,76	11,52	12,76	12
2,20 kN/m ²	W _{max} (mm)	500	500	500	800	800	800	1400
1,60 kN/m ²		500	500	800	800	800	1200	1500
1,40 kN/m ²		500	500	800	800	800	1200	1500
1,04 kN/m ²		800	800	800	1200	1200	1400	1500
1,00 kN/m ²		800	800	800	1200	1200	1500	1500
0,64 kN/m ²		1200	1200	1200	1500	1500	1500	1500

MOD 26

316



Flat or tube
Ø 42,4 mm
Ø 48,3 mm

F (Force)	Glass type	VSG / TVG*					VSG / ESG*					Mono / ESG-H*		
	T (mm)	8,76	9,52	10,76	11,52	12,76	8,76	9,52	10,76	11,52	12,76	8	10	12
2,20 kN/m ²	W _{max} (mm)						500	500	500	800	800	800	1000	1400
1,60 kN/m ²							500	500	800	800	800	1000	1000	1400
1,40 kN/m ²							800	800	800	800	1000	1000	1200	1400
1,04 kN/m ²		500	500	800	800	1000	800	800	1000	1000	1400	1400	1400	1400
1,00 kN/m ²		500	500	800	800	1000	800	800	1200	1200	1400	1400	1400	1400
0,64 kN/m ²		800	800	1000	1000	1200	1200	1200	1400	1400	1400	1400	1400	1400

Glass clamps - EN-12600 - Test results (fascia mount)

MOD 24 / 25 Test setup

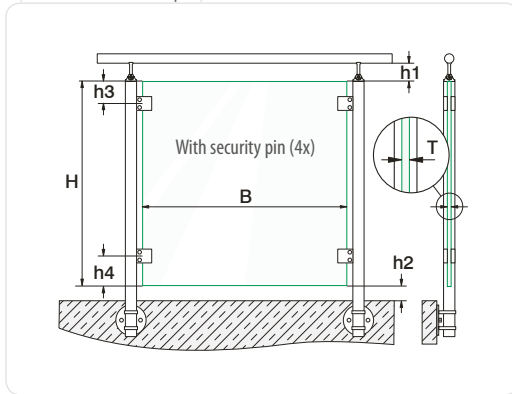

Dimensions (mm)	min. (mm)	max. (mm)
B Glass width	500	See table
T Glass thickness	See table	See table
H Glass height	800	1000
h1 Handrail - top glass panel	10	50 without edge protection 120 with edge protection
h2 Floor - base glass panel	10	50 without edge protection 120 with edge protection
h3 Top glass panel - upper glass clamp	150	150
h4 Lower glass clamp - base glass panel	150	150

INDOOR

Glass clamps with security pin, without security plate.

MOD 24

Zinc

316

Flat or tube
Ø 48,3 mm

Glass type	VSG / ESG*				Mono / ESG-H*	
T (mm)	12,76	13,52	16,76	17,52	12	16
W _{max} (mm)	500 - 1600	500 - 1600	500 - 1600	500 - 1600	500 - 1600	500 - 1600

MOD 25

Zinc

316

Flat or tube
Ø 42,4 mm
Ø 48,3 mm

Glass type	VSG / ESG*
T (mm)	12,76
W _{max} (mm)	500 - 1600

OUTDOOR

Possible width of glass for outdoor use depending on wind factor, glass type and glass thickness with security pin, without security plate.

MOD 24

316

Flat or tube
Ø 48,3 mm

F (Force)	Glass type	VSG / ESG*				Mono / ESG-H*	
2,20 kN/m ²	T (mm)	12,76	13,52	16,76	17,52	12	16
	W _{max} (mm)	500	500	1000	1000	1400	1600
800		800	1200	1200	1500	1600	
800		800	1400	1400	1600	1600	
1200		1200	1600	1600	1600	1600	
1200		1200	1600	1600	1600	1600	
1500		1500	1600	1600	1600	1600	

MOD 25

316

Flat or tube
Ø 42,4 mm
Ø 48,3 mm

F (Force)	Glass type	VSG / ESG*
2,20 kN/m ²	T (mm)	12,76
	W _{max} (mm)	800
1000		
1000		
1400		
1400		
1600		

* VSG: Laminated glass
Mono: Single Panel glassSPG: Float/Annealed glass
TVG: Heat strengthened glassESG: Toughened glass
ESG-H: Heat Soaked Toughened glass

Glass clamps - EN-12600 - Test results (fascia mount)

MOD 24 / 26 Test setup

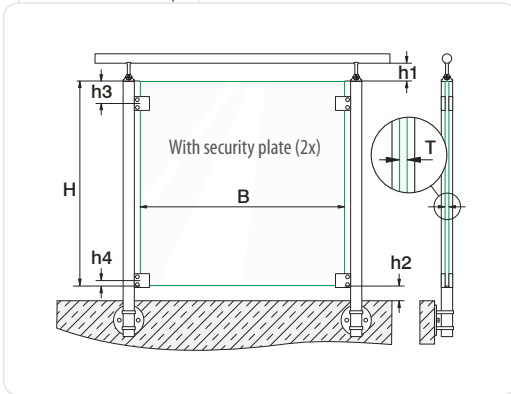

Dimensions (mm)		min.	max.
B	Glass width	500	See table
T	Glass thickness	See table	See table
H	Glass height	800	1000
h1	Handrail - top glass panel	10	50 without edge protection 120 with edge protection
h2	Floor - base glass panel	10	50 without edge protection 120 with edge protection
h3	Top glass panel - upper glass clamp	100	150
h4	Lower glass clamp - base glass panel	32 (MOD 24) 21 (MOD 26)	32 (MOD 24) 21 (MOD 26)

INDOOR



Glass clamps without security pin, with security plate.

MOD 24

Zinc 316



Flat or tube
Ø 48,3 mm

Glass type	VSG / TVG*				VSG / ESG*				Mono / ESG-H*		
	T (mm)	12,76	13,52	16,76	17,52	12,76	13,52	16,76	17,52	12	16
W _{max} (mm)	500 - 1500	500 - 1500	500 - 1500	500 - 1500	500 - 1600	500 - 1600	500 - 1600	500 - 1600	500 - 1600	500 - 1600	500 - 1600

MOD 26

Zinc 316



Flat or tube
Ø 42,4 mm
Ø 48,3 mm

Glass type	VSG / ESG*					Mono / ESG-H*			
	T (mm)	8,76	9,52	10,76	11,52	12,76	8	10	12
W _{max} (mm)	500 - 1400	500 - 1400	500 - 1400	500 - 1400	500 - 1400	500 - 1400	500 - 1400	500 - 1400	500 - 1400

OUTDOOR



Possible width of glass for outdoor use depending on wind factor, glass type and glass thickness without security pin, with security plate.

MOD 24

316



Flat or tube
Ø 48,3 mm

F (Force)	Glass type	VSG / TVG*				VSG / ESG*				Mono / ESG-H*	
		T (mm)	12,76	13,52	16,76	17,52	12,76	13,52	16,76	17,52	12
2,20 kN/m ²	W _{max} (mm)	500	500	500	500	500	500	1000	1000	1400	1600
1,60 kN/m ²		500	500	800	800	800	800	1200	1200	1500	1600
1,40 kN/m ²		500	500	1000	1000	800	800	1400	1400	1600	1600
1,04 kN/m ²		800	800	1200	1200	1200	1200	1500	1500	1600	1600
1,00 kN/m ²		800	800	1200	1200	1200	1200	1500	1500	1600	1600
1,00 kN/m ²		1500	1500	1500	1500	1500	1500	1600	1600	1600	1600
0,64 kN/m ²		1500	1500	1500	1500	1500	1500	1600	1600	1600	1600

MOD 26

316



Flat or tube
Ø 42,4 mm
Ø 48,3 mm

F (Force)	Glass type	VSG / ESG*					Mono / ESG-H*			
		T (mm)	8,76	9,52	10,76	11,52	12,76	8	10	12
2,20 kN/m ²	W _{max} (mm)	500	500	800	800	800	800	800	1000	1400
1,60 kN/m ²		800	800	800	800	800	1000	1000	1400	1400
1,40 kN/m ²		800	800	1000	1000	1200	1200	1200	1400	1400
1,04 kN/m ²		800	800	1000	1000	1400	1400	1400	1400	1400
1,00 kN/m ²		800	800	1200	1200	1400	1400	1400	1400	1400
0,64 kN/m ²		1200	1200	1400	1400	1400	1400	1400	1400	1400

* VSG: Laminated glass
Mono: Single Panel glass

SPG: Float/Annealed glass
TVG: Heat strengthened glass

ESG: Toughened glass
ESG-H: Heat Soaked Toughened glass

Flat

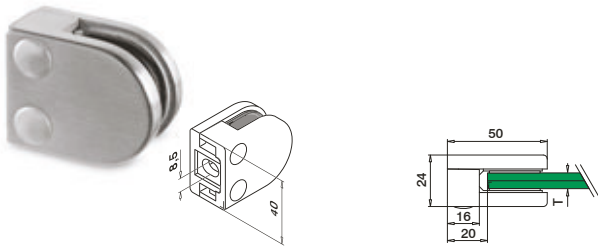

MOD 20

MONO	304			
INDOOR				
13.2006.000.12	6	QS-47	301	4
13.2008.000.12	8	QS-47	301	4

LAM.	304			
INDOOR				
13.2007.000.12	6,76 (3 - 0,76 - 3)	QS-47	301	4

MONO	316			
OUTDOOR				
14.2006.000.12	6	QS-45	301	4
14.2008.000.12	8	QS-45	301	4

LAM.	316			
OUTDOOR				
14.2007.000.12	6,76 (3 - 0,76 - 3)	QS-45	301	4



MOD 20 tested for INDOOR

Tube

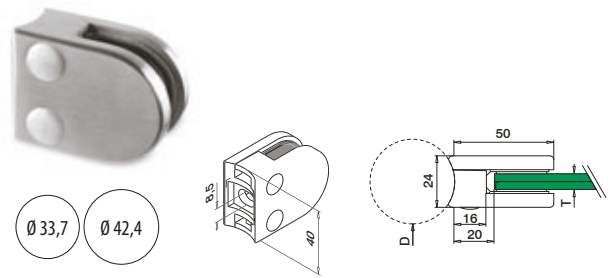

MOD 20

MONO	304			
INDOOR				
13.2006.033.12	Ø 33,7	6	QS-47	301 4
13.2008.033.12	Ø 33,7	8	QS-47	301 4
13.2006.042.12	Ø 42,4	6	QS-47	301 4
13.2008.042.12	Ø 42,4	8	QS-47	301 4

LAM.	304			
INDOOR				
13.2007.033.12	Ø 33,7	6,76 (3 - 0,76 - 3)	QS-47	301 4
13.2007.042.12	Ø 42,4	6,76 (3 - 0,76 - 3)	QS-47	301 4

MONO	316			
OUTDOOR				
14.2006.033.12	Ø 33,7	6	QS-45	301 4
14.2008.033.12	Ø 33,7	8	QS-45	301 4
14.2006.042.12	Ø 42,4	6	QS-45	301 4
14.2008.042.12	Ø 42,4	8	QS-45	301 4

LAM.	316			
OUTDOOR				
14.2007.033.12	Ø 33,7	6,76 (3 - 0,76 - 3)	QS-45	301 4
14.2007.042.12	Ø 42,4	6,76 (3 - 0,76 - 3)	QS-45	301 4



MOD 20 tested for INDOOR

Q-INFO

MOD 0715

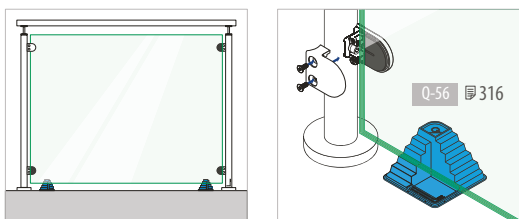

Q-INFO

Article number-system for glass clamps

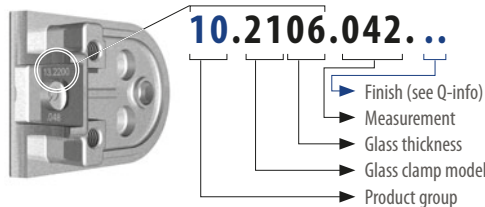

Please order fixing bolts separately.

Q-INFO



Q-INFO



Glass clamps - MOD 20

Flat

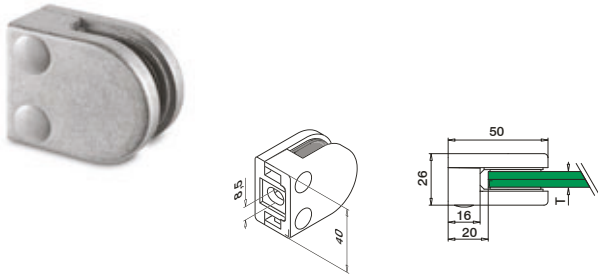

MOD 20

Zinc				
MONO	INDOOR	T		
	10.2006.000...	6	QS-46 301	4
	10.2008.000...	8	QS-46 301	4

Zinc				
LAM.	INDOOR	T		
	10.2007.000...	6,76 (3 - 0,76 - 3)	QS-46 301	4



Tube

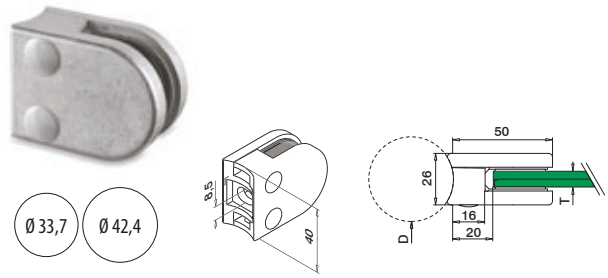

MOD 20

Zinc				
MONO	INDOOR	D	T	
	10.2006.033...	Ø 33,7	6	QS-46 301 4
	10.2008.033...	Ø 33,7	8	QS-46 301 4
	10.2006.042...	Ø 42,4	6	QS-46 301 4
	10.2008.042...	Ø 42,4	8	QS-46 301 4

Zinc				
LAM.	INDOOR	D	T	
	10.2007.033...	Ø 33,7	6,76 (3 - 0,76 - 3)	QS-46 301 4
	10.2007.042...	Ø 42,4	6,76 (3 - 0,76 - 3)	QS-46 301 4



Flat

Q-INFO

Zinc

MOD 20 Finishes

Raw

Matt chrome

Chrome plated

Stainless steel effect



10.20...000.00

10.20...000.16

10.20...000.17

10.20...000.19

Black
RAL 9005

White
RAL 9016

Aluminium
white RAL 9006



10.20...000.31

10.20...000.32

10.20...000.36

Please order fixing bolts separately.

Tube

Q-INFO

Zinc

MOD 20 Finishes

Raw

Chrome plated

Stainless steel effect



10.20.....00

10.20.....17

10.20.....19

Flat

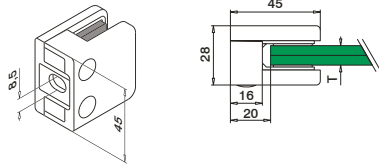

MOD 21



304				
INDOOR	T			
13.2106.000.12	6	QS-47	301	4
13.2108.000.12	8	QS-47	301	4
13.2110.000.12	10	QS-47	301	4



304				
INDOOR	T			
13.2107.000.12	6,76 (3 - 0,76 - 3)	QS-47	301	4
13.2109.000.12	8,76 (4 - 0,76 - 4)	QS-47	301	4
13.2144.000.12	9,52 (4 - 1,52 - 4)	QS-47	301	4



316				
OUTDOOR	T			
14.2106.000.12	6	QS-45	301	4
14.2108.000.12	8	QS-45	301	4
14.2110.000.12	10	QS-45	301	4



316				
OUTDOOR	T			
14.2107.000.12	6,76 (3 - 0,76 - 3)	QS-45	301	4
14.2109.000.12	8,76 (4 - 0,76 - 4)	QS-45	301	4
14.2144.000.12	9,52 (4 - 1,52 - 4)	QS-45	301	4



MOD 21 tested for INDOOR

Tube

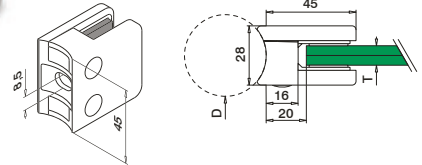
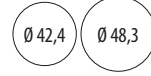

MOD 21



304					
INDOOR	D	T			
13.2106.042.12	Ø 42,4	6	QS-47	301	4
13.2108.042.12	Ø 42,4	8	QS-47	301	4
13.2110.042.12	Ø 42,4	10	QS-47	301	4
13.2106.048.12	Ø 48,3	6	QS-47	301	4
13.2108.048.12	Ø 48,3	8	QS-47	301	4
13.2110.048.12	Ø 48,3	10	QS-47	301	4



304					
INDOOR	D	T			
13.2107.042.12	Ø 42,4	6,76 (3 - 0,76 - 3)	QS-47	301	4
13.2109.042.12	Ø 42,4	8,76 (4 - 0,76 - 4)	QS-47	301	4
13.2144.042.12	Ø 42,4	9,52 (4 - 1,52 - 4)	QS-47	301	4
13.2109.048.12	Ø 48,3	8,76 (4 - 0,76 - 4)	QS-47	301	4



316					
OUTDOOR	D	T			
14.2106.042.12	Ø 42,4	6	QS-45	301	4
14.2108.042.12	Ø 42,4	8	QS-45	301	4
14.2110.042.12	Ø 42,4	10	QS-45	301	4
14.2106.048.12	Ø 48,3	6	QS-45	301	4
14.2108.048.12	Ø 48,3	8	QS-45	301	4
14.2110.048.12	Ø 48,3	10	QS-45	301	4



316					
OUTDOOR	D	T			
14.2107.042.12	Ø 42,4	6,76 (3 - 0,76 - 3)	QS-45	301	4
14.2109.042.12	Ø 42,4	8,76 (4 - 0,76 - 4)	QS-45	301	4
14.2144.042.12	Ø 42,4	9,52 (4 - 1,52 - 4)	QS-45	301	4
14.2109.048.12	Ø 48,3	8,76 (4 - 0,76 - 4)	QS-45	301	4



MOD 21 tested for INDOOR

Q-INFO



Q-23

Q-cleaner

300 ml

19.0601.000.00

Q-INFO



Q-22

Q-ultra-clean

500 ml

19.0610.000.00

Please order fixing bolts separately.

Glass clamps - MOD 21

Flat

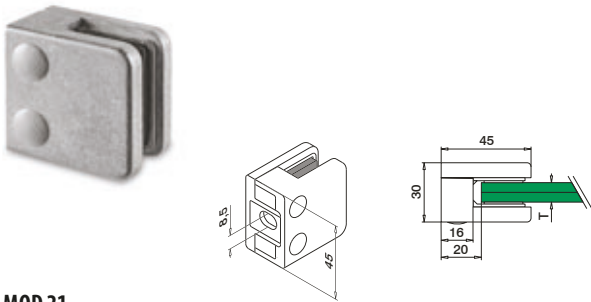

MOD 21

Zinc				
INDOOR		T		
10.2106.000...		6	QS-46 301	4
10.2108.000...		8	QS-46 301	4
10.2110.000...		10	QS-46 301	4

Zinc				
INDOOR		T		
10.2107.000...		6,76 (3 - 0,76 - 3)	QS-46 301	4
10.2109.000...		8,76 (4 - 0,76 - 4)	QS-46 301	4
10.2144.000...		9,52 (4 - 1,52 - 4)	QS-46 301	4



Tube

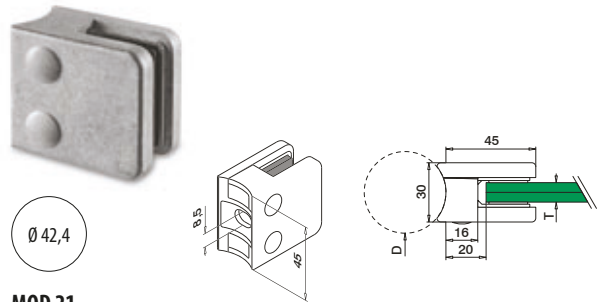

MOD 21

Zinc				
INDOOR		D	T	
10.2106.042...		Ø 42,4	6	QS-46 301 4
10.2108.042...		Ø 42,4	8	QS-46 301 4
10.2110.042...		Ø 42,4	10	QS-46 301 4

Zinc				
INDOOR		D	T	
10.2107.042...		Ø 42,4	6,76 (3 - 0,76 - 3)	QS-46 301 4
10.2109.042...		Ø 42,4	8,76 (4 - 0,76 - 4)	QS-46 301 4
10.2144.042...		Ø 42,4	9,52 (4 - 1,52 - 4)	QS-46 301 4



Please order fixing bolts separately.

Flat

Q-INFO Zinc MOD 21 Finishes

Raw Matt chrome Chrome plated Stainless steel effect



10.21...000.00 10.21...000.16 10.21...000.17 10.21...000.19

Black RAL 9005 White RAL 9016 Aluminium white RAL 9006



10.21...000.31 10.21...000.32 10.21...000.36

Tube

Q-INFO Zinc MOD 21 Finishes

Raw Chrome plated Stainless steel effect



10.21.....00 10.21.....17 10.21.....19

Q-INFO

Article number-system for glass clamps

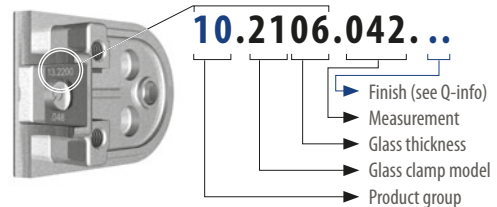

Flat

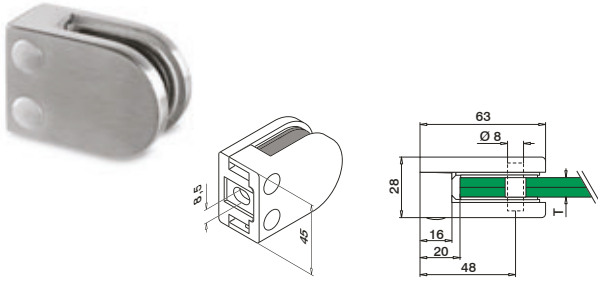

Tube

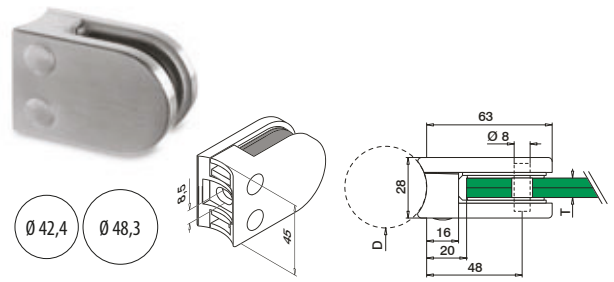

MOD 22

MONO		304 INDOOR		T		
13.2206.000...		6	QS-47	301	4	
13.2208.000...		8	QS-47	301	4	
13.2210.000...		10	QS-47	301	4	

LAM.		304 INDOOR		T		
13.2207.000...	6,76 (3 - 0,76 - 3)	QS-47	301	4		
13.2241.000...	8,38 (4 - 0,38 - 4)	QS-47	301	4		
13.2209.000...	8,76 (4 - 0,76 - 4)	QS-47	301	4		
13.2244.000...	9,52 (4 - 1,52 - 4)	QS-47	301	4		



MOD 22

MONO		316 OUTDOOR		T		
14.2206.000...		6	QS-45	301	4	
14.2208.000...		8	QS-45	301	4	
14.2210.000...		10	QS-45	301	4	

LAM.		316 OUTDOOR		T		
14.2207.000...	6,76 (3 - 0,76 - 3)	QS-45	301	4		
14.2241.000...	8,38 (4 - 0,38 - 4)	QS-45	301	4		
14.2209.000...	8,76 (4 - 0,76 - 4)	QS-45	301	4		
14.2244.000...	9,52 (4 - 1,52 - 4)	QS-45	301	4		



MOD 22

MONO		304 INDOOR		D	T		
13.2206.042...		Ø 42,4	6	QS-47	301	4	
13.2208.042...		Ø 42,4	8	QS-47	301	4	
13.2210.042...		Ø 42,4	10	QS-47	301	4	
13.2206.048...		Ø 48,3	6	QS-47	301	4	
13.2208.048...		Ø 48,3	8	QS-47	301	4	
13.2210.048...		Ø 48,3	10	QS-47	301	4	

LAM.		304 INDOOR		D	T		
13.2207.042...	Ø 42,4	6,76 (3 - 0,76 - 3)	QS-47	301	4		
13.2241.042...	Ø 42,4	8,38 (4 - 0,38 - 4)	QS-47	301	4		
13.2209.042...	Ø 42,4	8,76 (4 - 0,76 - 4)	QS-47	301	4		
13.2244.042...	Ø 42,4	9,52 (4 - 1,52 - 4)	QS-47	301	4		
13.2207.048...	Ø 48,3	6,76 (3 - 0,76 - 3)	QS-47	301	4		
13.2241.048...	Ø 48,3	8,38 (4 - 0,38 - 4)	QS-47	301	4		
13.2209.048...	Ø 48,3	8,76 (4 - 0,76 - 4)	QS-47	301	4		
13.2244.048...	Ø 48,3	9,52 (4 - 1,52 - 4)	QS-47	301	4		



MOD 22

MONO		316 OUTDOOR		D	T		
14.2206.042...		Ø 42,4	6	QS-45	301	4	
14.2208.042...		Ø 42,4	8	QS-45	301	4	
14.2210.042...		Ø 42,4	10	QS-45	301	4	
14.2206.048...		Ø 48,3	6	QS-45	301	4	
14.2208.048...		Ø 48,3	8	QS-45	301	4	
14.2210.048...		Ø 48,3	10	QS-45	301	4	

LAM.		316 OUTDOOR		D	T		
14.2207.042...	Ø 42,4	6,76 (3 - 0,76 - 3)	QS-45	301	4		
14.2241.042...	Ø 42,4	8,38 (4 - 0,38 - 4)	QS-45	301	4		
14.2209.042...	Ø 42,4	8,76 (4 - 0,76 - 4)	QS-45	301	4		
14.2244.042...	Ø 42,4	9,52 (4 - 1,52 - 4)	QS-45	301	4		
14.2207.048...	Ø 48,3	6,76 (3 - 0,76 - 3)	QS-45	301	4		
14.2241.048...	Ø 48,3	8,38 (4 - 0,38 - 4)	QS-45	301	4		
14.2209.048...	Ø 48,3	8,76 (4 - 0,76 - 4)	QS-45	301	4		
14.2244.048...	Ø 48,3	9,52 (4 - 1,52 - 4)	QS-45	301	4		



Please order security pins and fixing bolts separately.

Flat

Q-INFO 304 MOD 22 Finishes

Satin	Polished
13.22.....12	13.22.....10

Q-INFO 316 MOD 22 Finishes

Satin	Polished
14.22.....12	14.22.....10

Glass clamps - MOD 22

Flat

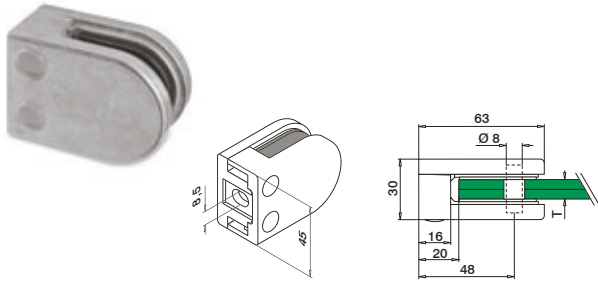

MOD 22

MONO	Zinc		T	Screw	Box	
	INDOOR					
10.2206.000...			6	QS-46	301	4
10.2208.000...			8	QS-46	301	4
10.2210.000...			10	QS-46	301	4

LAM.	Zinc		T	Screw	Box	
	INDOOR					
10.2207.000...	6,76	(3 - 0,76 - 3)		QS-46	301	4
10.2241.000...	8,38	(4 - 0,38 - 4)		QS-46	301	4
10.2209.000...	8,76	(4 - 0,76 - 4)		QS-46	301	4
10.2244.000...	9,52	(4 - 1,52 - 4)		QS-46	301	4



If you have a specific requirement for pre-assembled products please use our order forms on pages 324 - 336.

Tube

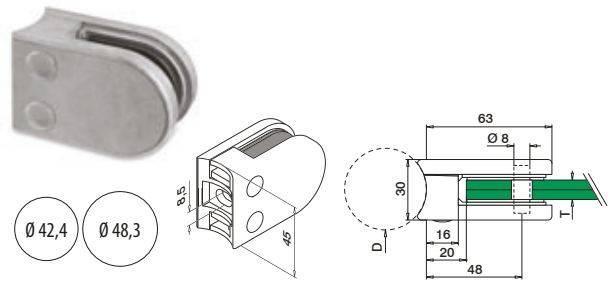

MOD 22

MONO	Zinc		T	Screw	Box	
	INDOOR	D				
10.2206.042...		Ø 42,4	6	QS-46	301	4
10.2208.042...		Ø 42,4	8	QS-46	301	4
10.2210.042...		Ø 42,4	10	QS-46	301	4
10.2206.048...		Ø 48,3	6	QS-46	301	4
10.2208.048...		Ø 48,3	8	QS-46	301	4
10.2210.048...		Ø 48,3	10	QS-46	301	4

LAM.	Zinc		T	Screw	Box	
	INDOOR	D				
10.2207.042...	Ø 42,4	6,76	(3 - 0,76 - 3)	QS-46	301	4
10.2241.042...	Ø 42,4	8,38	(4 - 0,38 - 4)	QS-46	301	4
10.2209.042...	Ø 42,4	8,76	(4 - 0,76 - 4)	QS-46	301	4
10.2244.042...	Ø 42,4	9,52	(4 - 1,52 - 4)	QS-46	301	4
10.2207.048...	Ø 48,3	6,76	(3 - 0,76 - 3)	QS-46	301	4
10.2241.048...	Ø 48,3	8,38	(4 - 0,38 - 4)	QS-46	301	4
10.2209.048...	Ø 48,3	8,76	(4 - 0,76 - 4)	QS-46	301	4
10.2244.048...	Ø 48,3	9,52	(4 - 1,52 - 4)	QS-46	301	4



Please order security pins and fixing bolts separately.

Flat

Q-INFO	Zinc	MOD 22 Finishes	
Raw	Matt chrome	Chrome plated	Stainless steel effect
10.22.....00	10.22.....16	10.22.....17	10.22.....19
Black RAL 9005	White RAL 9016	Aluminium white RAL 9006	
10.22.....31	10.22.....32	10.22.....36	

Tube

Q-INFO	Zinc	MOD 22 Finishes	
Raw	Chrome plated	Stainless steel effect	
10.22.....00	10.22.....17	10.22.....19	
Q-INFO	MOD 5015		

Flat

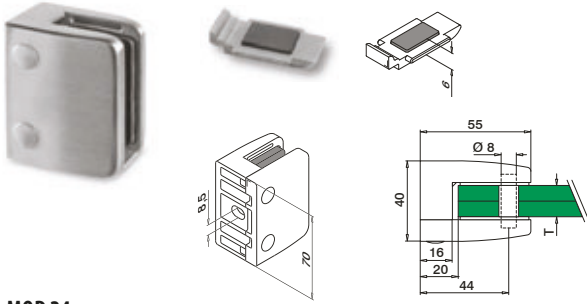

MOD 24

MONO	304 INDOOR	T		
	13.2412.000.12	12	QS-47	301 4
	13.2415.000.12	15	QS-47	301 4

LAM.	304 INDOOR	T		
	13.2444.000.12	9,52 (4 - 1,52 - 4)	QS-47	301 4
	13.2454.000.12	11,52 (5 - 1,52 - 5)	QS-47	301 4
	13.2413.000.12	12,76 (6 - 0,76 - 6)	QS-47	301 4
	13.2464.000.12	13,52 (6 - 1,52 - 6)	QS-47	301 4
	13.2417.000.12	16,76 (8 - 0,76 - 8)	QS-47	301 4
	13.2418.000.12	17,52 (8 - 1,52 - 8)	QS-47	301 4

Tube

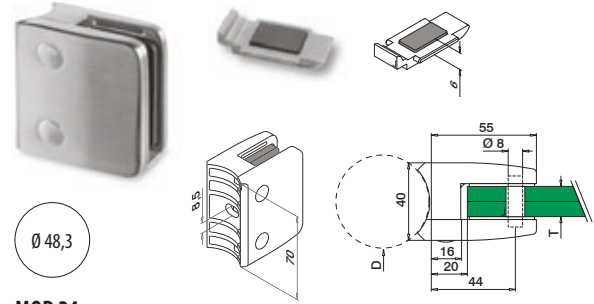

MOD 24

MONO	304 INDOOR	D	T		
	13.2412.048.12	Ø 48,3	12	QS-47	301 4
	13.2415.048.12	Ø 48,3	15	QS-47	301 4

LAM.	304 INDOOR	D	T		
	13.2444.048.12	Ø 48,3	9,52 (4 - 1,52 - 4)	QS-47	301 4
	13.2454.048.12	Ø 48,3	11,52 (5 - 1,52 - 5)	QS-47	301 4
	13.2413.048.12	Ø 48,3	12,76 (6 - 0,76 - 6)	QS-47	301 4
	13.2464.048.12	Ø 48,3	13,52 (6 - 1,52 - 6)	QS-47	301 4
	13.2417.048.12	Ø 48,3	16,76 (8 - 0,76 - 8)	QS-47	301 4
	13.2418.048.12	Ø 48,3	17,52 (8 - 1,52 - 8)	QS-47	301 4

MONO	316 OUTDOOR	T		
	14.2412.000.12	12	QS-45	301 4
	14.2415.000.12	15	QS-45	301 4

LAM.	316 OUTDOOR	T		
	14.2444.000.12	9,52 (4 - 1,52 - 4)	QS-45	301 4
	14.2454.000.12	11,52 (5 - 1,52 - 5)	QS-45	301 4
	14.2413.000.12	12,76 (6 - 0,76 - 6)	QS-45	301 4
	14.2464.000.12	13,52 (6 - 1,52 - 6)	QS-45	301 4
	14.2417.000.12	16,76 (8 - 0,76 - 8)	QS-45	301 4
	14.2418.000.12	17,52 (8 - 1,52 - 8)	QS-45	301 4

MONO	316 OUTDOOR	D	T		
	14.2412.048.12	Ø 48,3	12	QS-45	301 4
	14.2415.048.12	Ø 48,3	15	QS-45	301 4

LAM.	316 OUTDOOR	D	T		
	14.2444.048.12	Ø 48,3	9,52 (4 - 1,52 - 4)	QS-45	301 4
	14.2454.048.12	Ø 48,3	11,52 (5 - 1,52 - 5)	QS-45	301 4
	14.2413.048.12	Ø 48,3	12,76 (6 - 0,76 - 6)	QS-45	301 4
	14.2464.048.12	Ø 48,3	13,52 (6 - 1,52 - 6)	QS-45	301 4
	14.2417.048.12	Ø 48,3	16,76 (8 - 0,76 - 8)	QS-45	301 4
	14.2418.048.12	Ø 48,3	17,52 (8 - 1,52 - 8)	QS-45	301 4



Q-INFO

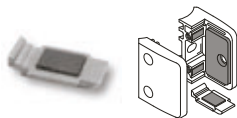

Insert the security plate into the glass clamp instead of using a security pin. Your costs are reduced because drilling the glass is not required.

Please order security pins and fixing bolts separately.

Q-INFO

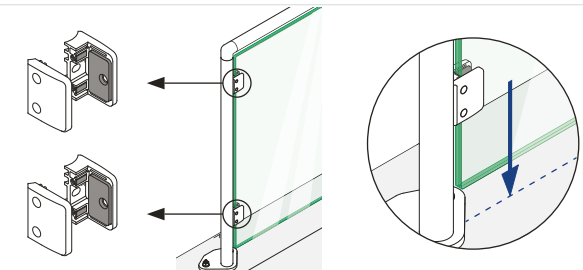
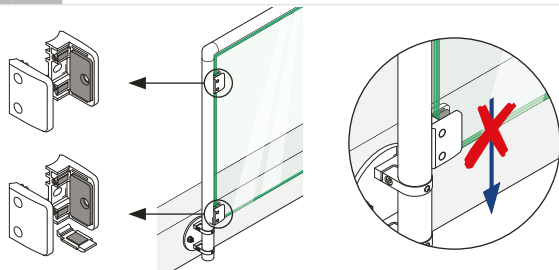

Glass clamps - MOD 24

Flat

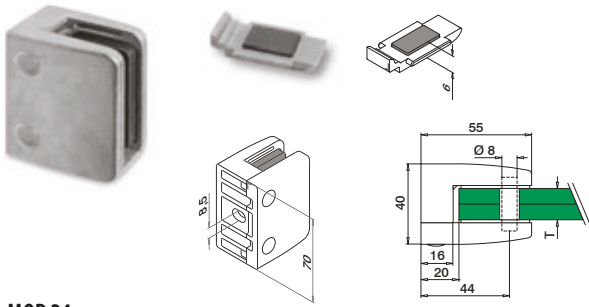

MOD 24

MONO	Zinc		Screw	Pin
	INDOOR	T		
10.2412.000...		12	QS-46	301
10.2415.000...		15	QS-46	301

LAM.	Zinc		Screw	Pin
	INDOOR	T		
10.2444.000...	9,52 (4 - 1,52 - 4)		QS-46	301
10.2454.000...	11,52 (5 - 1,52 - 5)		QS-46	301
10.2413.000...	12,76 (6 - 0,76 - 6)		QS-46	301
10.2464.000...	13,52 (6 - 1,52 - 6)		QS-46	301
10.2417.000...	16,76 (8 - 0,76 - 8)		QS-46	301
10.2418.000...	17,52 (8 - 1,52 - 8)		QS-46	301



Tube

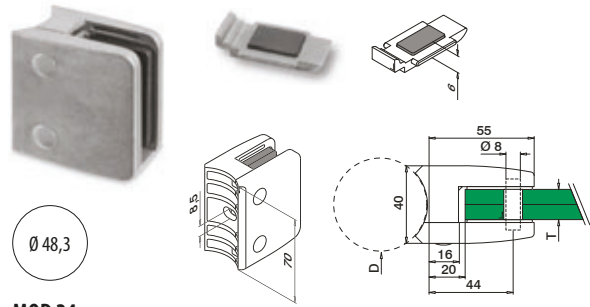

MOD 24

MONO	Zinc		Screw	Pin
	INDOOR	D		
10.2412.048.00		Ø 48,3	QS-46	301
10.2415.048.00		Ø 48,3	QS-46	301

LAM.	Zinc		Screw	Pin
	INDOOR	D		
10.2444.048.00	9,52 (4 - 1,52 - 4)	Ø 48,3	QS-46	301
10.2454.048.00	11,52 (5 - 1,52 - 5)	Ø 48,3	QS-46	301
10.2413.048.00	12,76 (6 - 0,76 - 6)	Ø 48,3	QS-46	301
10.2464.048.00	13,52 (6 - 1,52 - 6)	Ø 48,3	QS-46	301
10.2417.048.00	16,76 (8 - 0,76 - 8)	Ø 48,3	QS-46	301
10.2418.048.00	17,52 (8 - 1,52 - 8)	Ø 48,3	QS-46	301



Flat

Q-INFO

Zinc

MOD 24 Finishes

Raw

Stainless steel effect



10.24...000.00



10.24...000.19

Please order security pins and fixing bolts separately.

Q-INFO

MOD 5015

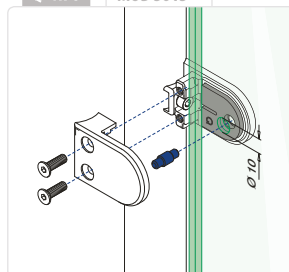

Q-INFO



Flat

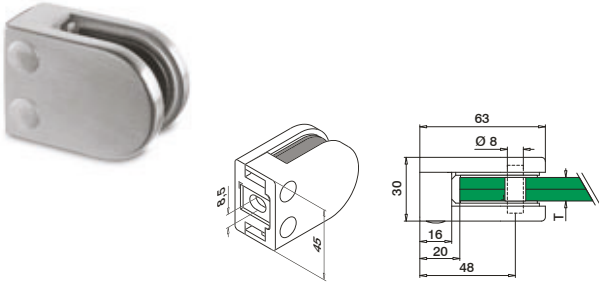

MOD 25

MONO	304	INDOOR	T	QS-47	301	4
		13.2512.000.12	12			

LAM.	304	INDOOR	T	QS-47	301	4
		13.2511.000.12	10,76 (5 - 0,76 - 5)			
		13.2554.000.12	11,52 (5 - 1,52 - 5)			
		13.2513.000.12	12,76 (6 - 0,76 - 6)			

MONO	316	OUTDOOR	T	QS-45	301	4
		14.2512.000.12	12			

LAM.	316	OUTDOOR	T	QS-45	301	4
		14.2511.000.12	10,76 (5 - 0,76 - 5)			
		14.2554.000.12	11,52 (5 - 1,52 - 5)			
		14.2513.000.12	12,76 (6 - 0,76 - 6)			



Tube

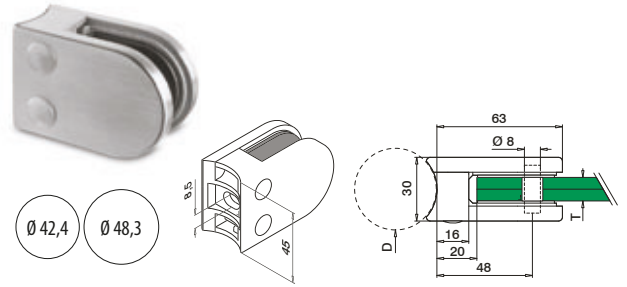

MOD 25

MONO	304	INDOOR	D	T	QS-47	301	4
		13.2512.042.12	Ø 42,4	12			
		13.2512.048.12	Ø 48,3	12			

LAM.	304	INDOOR	D	T	QS-47	301	4
		13.2511.042.12	Ø 42,4	10,76 (5 - 0,76 - 5)			
		13.2554.042.12	Ø 42,4	11,52 (5 - 1,52 - 5)			
		13.2513.042.12	Ø 42,4	12,76 (6 - 0,76 - 6)			
		13.2511.048.12	Ø 48,3	10,76 (5 - 0,76 - 5)			
		13.2554.048.12	Ø 48,3	11,52 (5 - 1,52 - 5)			
		13.2513.048.12	Ø 48,3	12,76 (6 - 0,76 - 6)			

MONO	316	OUTDOOR	D	T	QS-45	301	4
		14.2512.042.12	Ø 42,4	12			
		14.2512.048.12	Ø 48,3	12			

LAM.	316	OUTDOOR	D	T	QS-45	301	4
		14.2511.042.12	Ø 42,4	10,76 (5 - 0,76 - 5)			
		14.2554.042.12	Ø 42,4	11,52 (5 - 1,52 - 5)			
		14.2513.042.12	Ø 42,4	12,76 (6 - 0,76 - 6)			
		14.2511.048.12	Ø 48,3	10,76 (5 - 0,76 - 5)			
		14.2554.048.12	Ø 48,3	11,52 (5 - 1,52 - 5)			
		14.2513.048.12	Ø 48,3	12,76 (6 - 0,76 - 6)			



Please order security pins and fixing bolts separately.

Q-INFO



Q-23
Q-cleaner
300 ml
19.0601.000.00

Q-INFO



Q-22
Q-ultra-clean
500 ml
19.0610.000.00

Q-INFO

MOD 5015

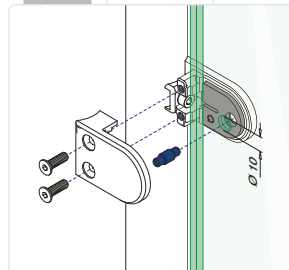

Glass clamps - MOD 25

Flat

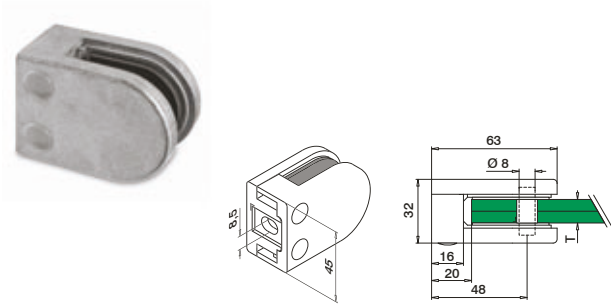

MOD 25

Zinc		T		
INDOOR				
10.2512.000...		12	QS-46 301	4

Zinc		T		
INDOOR				
10.2511.000...	10,76 (5 - 0,76 - 5)		QS-46 301	4
10.2513.000...	12,76 (6 - 0,76 - 6)		QS-46 301	4
10.2554.000...	11,52 (5 - 1,52 - 5)		QS-46 301	4



Tube

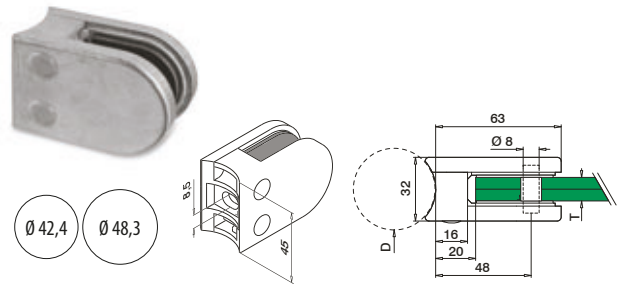

MOD 25

Zinc		D	T		
INDOOR					
10.2512.042...	Ø 42,4	12	QS-46 301	4	
10.2512.048...	Ø 48,3	12	QS-46 301	4	

Zinc		D	T		
INDOOR					
10.2511.042...	Ø 42,4	10,76 (5 - 0,76 - 5)	QS-46 301	4	
10.2513.042...	Ø 42,4	12,76 (6 - 0,76 - 6)	QS-46 301	4	
10.2554.042...	Ø 42,4	11,52 (5 - 1,52 - 5)	QS-46 301	4	
10.2511.048...	Ø 48,3	10,76 (5 - 0,76 - 5)	QS-46 301	4	
10.2513.048...	Ø 48,3	12,76 (6 - 0,76 - 6)	QS-46 301	4	
10.2554.048...	Ø 48,3	11,52 (5 - 1,52 - 5)	QS-46 301	4	



Please order security pins and fixing bolts separately.

Flat

Q-INFO Zinc MOD 25 Finishes

Raw Stainless steel effect Aluminium white RAL 9006



10.25...000.00 10.25...000.19 10.25...000.36

Tube

Q-INFO Zinc MOD 25 Finishes

Raw Stainless steel effect



10.25.....00 10.25.....19

Flat

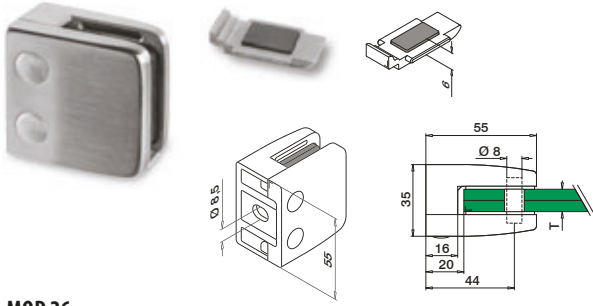

MOD 26



304

INDOOR	T		
13.2608.000.12	8	QS-47	301 4
13.2610.000.12	10	QS-47	301 4
13.2612.000.12	12	QS-47	301 4



304

INDOOR	T		
13.2609.000.12	8,76 (4 - 0,76 - 4)	QS-47	301 4
13.2644.000.12	9,52 (4 - 1,52 - 4)	QS-47	301 4
13.2611.000.12	10,76 (5 - 0,76 - 5)	QS-47	301 4
13.2654.000.12	11,52 (5 - 1,52 - 5)	QS-47	301 4
13.2613.000.12	12,76 (6 - 0,76 - 6)	QS-47	301 4



316

OUTDOOR	T		
14.2608.000.12	8	QS-45	301 4
14.2610.000.12	10	QS-45	301 4
14.2612.000.12	12	QS-45	301 4



316

OUTDOOR	T		
14.2609.000.12	8,76 (4 - 0,76 - 4)	QS-45	301 4
14.2644.000.12	9,52 (4 - 1,52 - 4)	QS-45	301 4
14.2611.000.12	10,76 (5 - 0,76 - 5)	QS-45	301 4
14.2654.000.12	11,52 (5 - 1,52 - 5)	QS-45	301 4
14.2613.000.12	12,76 (6 - 0,76 - 6)	QS-45	301 4



Q-INFO

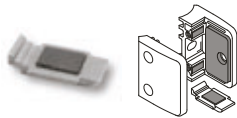

Insert the security plate into the glass clamp instead of using a security pin. Your costs are reduced because drilling the glass is not required.

Q-INFO



Q-23
Q-cleaner
300 ml
19.0601.000.00

Please order security pins and fixing bolts separately.

Q-INFO

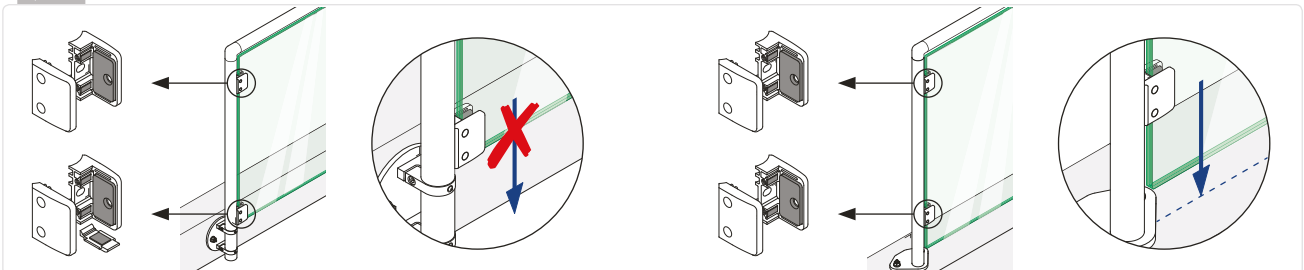

Tube

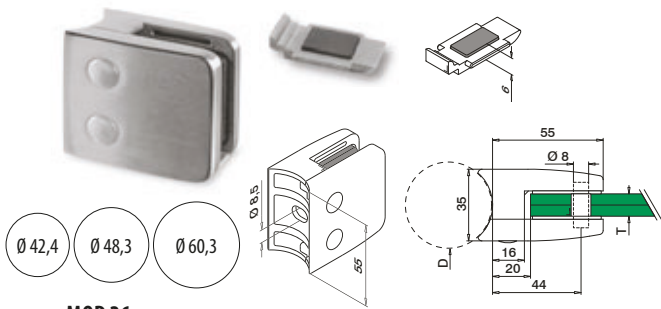

MOD 26

MONO	304	INDOOR	D	T	QS-47	301	4
		13.2608.042.12*	Ø 42,4	8	QS-47	301	4
		13.2610.042.12*	Ø 42,4	10	QS-47	301	4
		13.2612.042.12*	Ø 42,4	12	QS-47	301	4
		13.2608.048.12	Ø 48,3	8	QS-47	301	4
		13.2610.048.12	Ø 48,3	10	QS-47	301	4
		13.2612.048.12	Ø 48,3	12	QS-47	301	4
		13.2608.060.12	Ø 60,3	8	QS-47	301	4
		13.2610.060.12	Ø 60,3	10	QS-47	301	4
		13.2612.060.12	Ø 60,3	12	QS-47	301	4

LAM.	304	INDOOR	D	T	QS-47	301	4
		13.2609.042.12*	Ø 42,4	8,76 (4 - 0,76 - 4)	QS-47	301	4
		13.2644.042.12*	Ø 42,4	9,52 (4 - 1,52 - 4)	QS-47	301	4
		13.2611.042.12*	Ø 42,4	10,76 (5 - 0,76 - 5)	QS-47	301	4
		13.2654.042.12*	Ø 42,4	11,52 (5 - 1,52 - 5)	QS-47	301	4
		13.2613.042.12*	Ø 42,4	12,76 (6 - 0,76 - 6)	QS-47	301	4
		13.2609.048.12	Ø 48,3	8,76 (4 - 0,76 - 4)	QS-47	301	4
		13.2644.048.12	Ø 48,3	9,52 (4 - 1,52 - 4)	QS-47	301	4
		13.2611.048.12	Ø 48,3	10,76 (5 - 0,76 - 5)	QS-47	301	4
		13.2654.048.12	Ø 48,3	11,52 (5 - 1,52 - 5)	QS-47	301	4
		13.2613.048.12	Ø 48,3	12,76 (6 - 0,76 - 6)	QS-47	301	4
		13.2609.060.12	Ø 60,3	8,76 (4 - 0,76 - 4)	QS-47	301	4
		13.2644.060.12	Ø 60,3	9,52 (4 - 1,52 - 4)	QS-47	301	4
		13.2611.060.12	Ø 60,3	10,76 (5 - 0,76 - 5)	QS-47	301	4
		13.2654.060.12	Ø 60,3	11,52 (5 - 1,52 - 5)	QS-47	301	4
		13.2613.060.12	Ø 60,3	12,76 (6 - 0,76 - 6)	QS-47	301	4



MOD 26

MONO	316	OUTDOOR	D	T	QS-45	301	4
		14.2608.042.12*	Ø 42,4	8	QS-45	301	4
		14.2610.042.12*	Ø 42,4	10	QS-45	301	4
		14.2612.042.12*	Ø 42,4	12	QS-45	301	4
		14.2608.048.12	Ø 48,3	8	QS-45	301	4
		14.2610.048.12	Ø 48,3	10	QS-45	301	4
		14.2612.048.12	Ø 48,3	12	QS-45	301	4
		14.2608.060.12	Ø 60,3	8	QS-45	301	4
		14.2610.060.12	Ø 60,3	10	QS-45	301	4
		14.2612.060.12	Ø 60,3	12	QS-45	301	4

LAM.	316	OUTDOOR	D	T	QS-45	301	4
		14.2609.042.12*	Ø 42,4	8,76 (4 - 0,76 - 4)	QS-45	301	4
		14.2644.042.12*	Ø 42,4	9,52 (4 - 1,52 - 4)	QS-45	301	4
		14.2611.042.12*	Ø 42,4	10,76 (5 - 0,76 - 5)	QS-45	301	4
		14.2654.042.12*	Ø 42,4	11,52 (5 - 1,52 - 5)	QS-45	301	4
		14.2613.042.12*	Ø 42,4	12,76 (6 - 0,76 - 6)	QS-45	301	4
		14.2609.048.12	Ø 48,3	8,76 (4 - 0,76 - 4)	QS-45	301	4
		14.2644.048.12	Ø 48,3	9,52 (4 - 1,52 - 4)	QS-45	301	4
		14.2611.048.12	Ø 48,3	10,76 (5 - 0,76 - 5)	QS-45	301	4
		14.2654.048.12	Ø 48,3	11,52 (5 - 1,52 - 5)	QS-45	301	4
		14.2613.048.12	Ø 48,3	12,76 (6 - 0,76 - 6)	QS-45	301	4
		14.2609.060.12	Ø 60,3	8,76 (4 - 0,76 - 4)	QS-45	301	4
		14.2644.060.12	Ø 60,3	9,52 (4 - 1,52 - 4)	QS-45	301	4
		14.2611.060.12	Ø 60,3	10,76 (5 - 0,76 - 5)	QS-45	301	4
		14.2654.060.12	Ø 60,3	11,52 (5 - 1,52 - 5)	QS-45	301	4
		14.2613.060.12	Ø 60,3	12,76 (6 - 0,76 - 6)	QS-45	301	4



Q-INFO

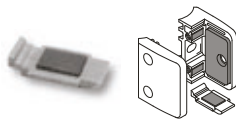

Insert the security plate into the glass clamp instead of using a security pin. Your costs are reduced because drilling the glass is not required.

Q-INFO



Q-22
Q-ultra-clean
500 ml
19.0610.000.00

Please order security pins and fixing bolts separately.

Q-INFO

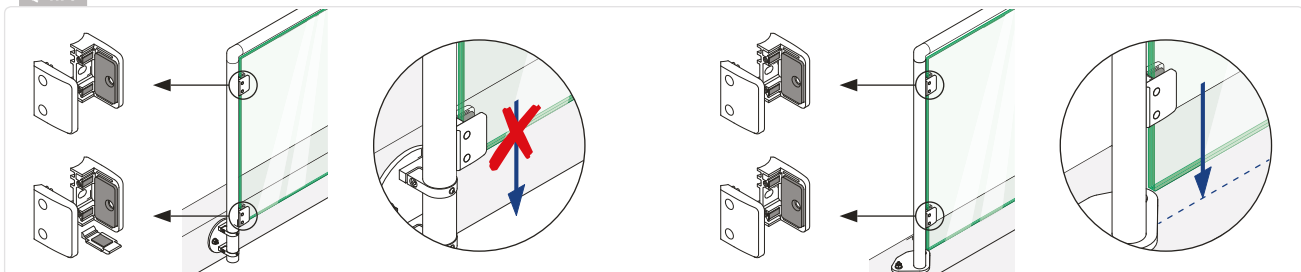

Glass clamps - MOD 26

Flat

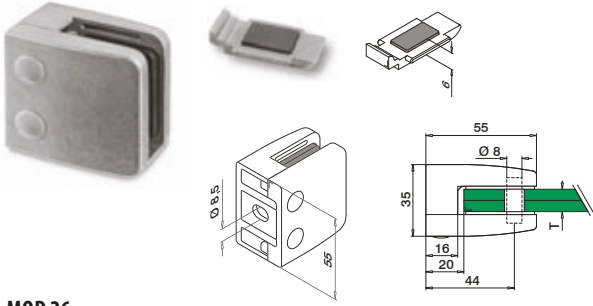

MOD 26

Zinc				
INDOOR		T		
10.2608.000...		8	QS-46 301	4
10.2610.000...		10	QS-46 301	4
10.2612.000...		12	QS-46 301	4

Zinc				
INDOOR		T		
10.2609.000...	8,76 (4 - 0,76 - 4)		QS-46 301	4
10.2644.000...	9,52 (4 - 1,52 - 4)		QS-46 301	4
10.2611.000...	10,76 (5 - 0,76 - 5)		QS-46 301	4
10.2654.000...	11,52 (5 - 1,52 - 5)		QS-46 301	4
10.2613.000...	12,76 (6 - 0,76 - 6)		QS-46 301	4



Tube

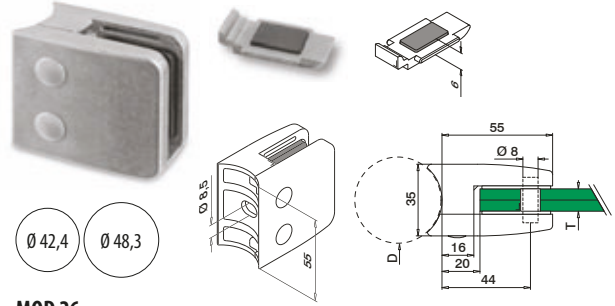

MOD 26

Zinc				
INDOOR		D	T	
10.2608.042...*	Ø 42,4	8	QS-46 301	4
10.2610.042...*	Ø 42,4	10	QS-46 301	4
10.2612.042...*	Ø 42,4	12	QS-46 301	4
10.2608.048...	Ø 48,3	8	QS-46 301	4
10.2610.048...	Ø 48,3	10	QS-46 301	4
10.2612.048...	Ø 48,3	12	QS-46 301	4

Zinc				
INDOOR		D	T	
10.2609.042...*	Ø 42,4	8,76 (4 - 0,76 - 4)	QS-46 301	4
10.2644.042...*	Ø 42,4	9,52 (4 - 1,52 - 4)	QS-46 301	4
10.2611.042...*	Ø 42,4	10,76 (5 - 0,76 - 5)	QS-46 301	4
10.2654.042...*	Ø 42,4	11,52 (5 - 1,52 - 5)	QS-46 301	4
10.2613.042...*	Ø 42,4	12,76 (6 - 0,76 - 6)	QS-46 301	4
10.2609.048...	Ø 48,3	8,76 (4 - 0,76 - 4)	QS-46 301	4
10.2644.048...	Ø 48,3	9,52 (4 - 1,52 - 4)	QS-46 301	4
10.2611.048...	Ø 48,3	10,76 (5 - 0,76 - 5)	QS-46 301	4
10.2654.048...	Ø 48,3	11,52 (5 - 1,52 - 5)	QS-46 301	4
10.2613.048...	Ø 48,3	12,76 (6 - 0,76 - 6)	QS-46 301	4



Please order security pins and fixing bolts separately.

Flat

Q-INFO

Zinc

MOD 26 Finishes

Raw



10.26.....00

Matt chrome



10.26.....16

Stainless steel effect



10.26.....19

Black RAL 9005



10.26.....31

White RAL 9016



10.26.....32

Aluminium white RAL 9006



10.26.....36

Tube

Q-INFO

Zinc

MOD 26 Finishes

Raw



10.26.....00

Stainless steel effect



10.26.....19



MORE SPECTACTULAR PHOTOS AT
WWW.Q-RAILING.COM

Flat

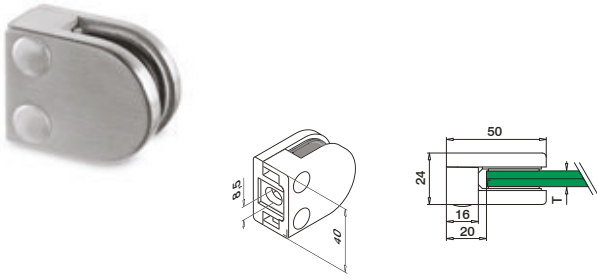

MOD 27

MONO	304		T		
	INDOOR				
13.2710.000.12			10	QS-47	301 4

LAM.	304		T		
	INDOOR				
13.2709.000.12		8,76 (4 - 0,76 - 4)		QS-47	301 4
13.2744.000.12		9,52 (4 - 1,52 - 4)		QS-47	301 4
13.2711.000.12		10,76 (5 - 0,76 - 5)		QS-47	301 4

MONO	316		T		
	OUTDOOR				
14.2710.000.12			10	QS-45	301 4

LAM.	316		T		
	OUTDOOR				
14.2709.000.12		8,76 (4 - 0,76 - 4)		QS-45	301 4
14.2744.000.12		9,52 (4 - 1,52 - 4)		QS-45	301 4
14.2711.000.12		10,76 (5 - 0,76 - 5)		QS-45	301 4



Tube

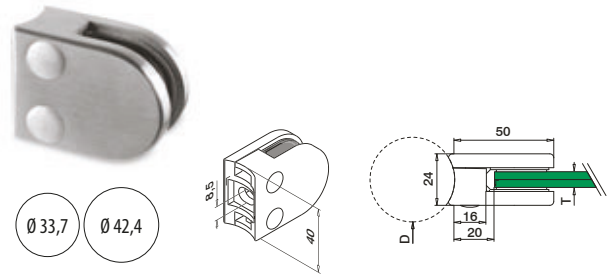

MOD 27

MONO	304		D	T		
	INDOOR					
13.2710.033.12			Ø 33,7	10	QS-47	301 4
13.2710.042.12			Ø 42,4	10	QS-47	301 4

LAM.	304		D	T		
	INDOOR					
13.2709.033.12		8,76 (4 - 0,76 - 4)	Ø 33,7		QS-47	301 4
13.2744.033.12		9,52 (4 - 1,52 - 4)	Ø 33,7		QS-47	301 4
13.2711.033.12		10,76 (5 - 0,76 - 5)	Ø 33,7		QS-47	301 4
13.2709.042.12		8,76 (4 - 0,76 - 4)	Ø 42,4		QS-47	301 4
13.2744.042.12		9,52 (4 - 1,52 - 4)	Ø 42,4		QS-47	301 4
13.2711.042.12		10,76 (5 - 0,76 - 5)	Ø 42,4		QS-47	301 4

MONO	316		D	T		
	OUTDOOR					
14.2710.033.12			Ø 33,7	10	QS-45	301 4
14.2710.042.12			Ø 42,4	10	QS-45	301 4

LAM.	316		D	T		
	OUTDOOR					
14.2709.033.12		8,76 (4 - 0,76 - 4)	Ø 33,7		QS-45	301 4
14.2744.033.12		9,52 (4 - 1,52 - 4)	Ø 33,7		QS-45	301 4
14.2711.033.12		10,76 (5 - 0,76 - 5)	Ø 33,7		QS-45	301 4
14.2709.042.12		8,76 (4 - 0,76 - 4)	Ø 42,4		QS-45	301 4
14.2744.042.12		9,52 (4 - 1,52 - 4)	Ø 42,4		QS-45	301 4
14.2711.042.12		10,76 (5 - 0,76 - 5)	Ø 42,4		QS-45	301 4



Please order fixing bolts separately.

Q-INFO MOD 0715

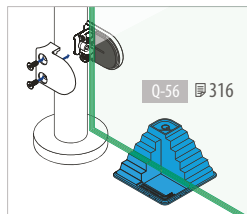
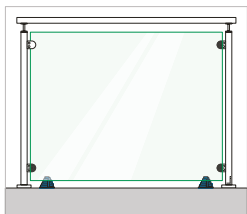

Q-INFO



Q-23
Q-cleaner
300 ml
19.0601.000.00

Q-INFO



Q-22
Q-ultra-clean
500 ml
19.0610.000.00

Glass clamps - MOD 27

Flat

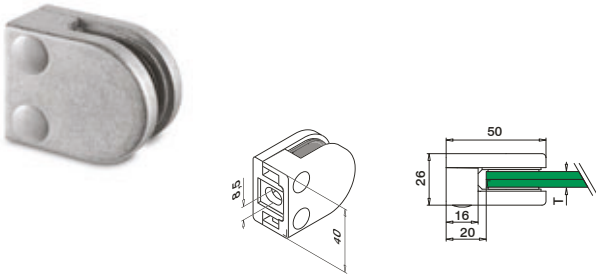

MOD 27

Zinc				
MONO	INDOOR	T		
	10.2710.000...	10	QS-46 301	4

Zinc				
LAM.	INDOOR	T		
	10.2709.000...	8,76 (4 - 0,76 - 4)	QS-46 301	4
	10.2744.000...	9,52 (4 - 1,52 - 4)	QS-46 301	4
	10.2711.000...	10,76 (5 - 0,76 - 5)	QS-46 301	4



If you have a specific requirement for pre-assembled products please use our order forms on pages 324 - 336.

Tube

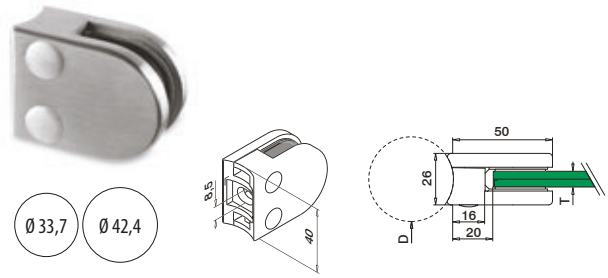

MOD 27

Zinc		Stainless steel effect			
MONO	INDOOR	D	T		
	10.2710.033.19	Ø 33,7	10	QS-46 301	4
	10.2710.042.19	Ø 42,4	10	QS-46 301	4

Zinc		Stainless steel effect			
LAM.	INDOOR	D	T		
	10.2709.033.19	Ø 33,7	8,76 (4 - 0,76 - 4)	QS-46 301	4
	10.2744.033.19	Ø 33,7	9,52 (4 - 1,52 - 4)	QS-46 301	4
	10.2711.033.19	Ø 33,7	10,76 (5 - 0,76 - 5)	QS-46 301	4
	10.2709.042.19	Ø 42,4	8,76 (4 - 0,76 - 4)	QS-46 301	4
	10.2744.042.19	Ø 42,4	9,52 (4 - 1,52 - 4)	QS-46 301	4
	10.2711.042.19	Ø 42,4	10,76 (5 - 0,76 - 5)	QS-46 301	4



Flat

Q-INFO

Zinc

MOD 27 Finishes

Raw

Chrome plated

Stainless steel effect



10.27.....00



10.27.....17



10.27.....19

Please order fixing bolts separately.



DESIGN
product

Flat

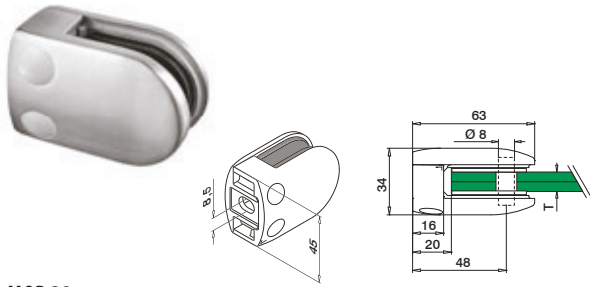

MOD 28



304				
INDOOR	T			
13.2806.000...	6	QS-47	301	4
13.2808.000...	8	QS-47	301	4
13.2810.000...	10	QS-47	301	4
13.2812.000...	12	QS-47	301	4



304				
INDOOR	T			
13.2807.000...	6,76 (3 - 0,76 - 3)	QS-47	301	4
13.2841.000...	8,38 (4 - 0,38 - 4)	QS-47	301	4
13.2809.000...	8,76 (4 - 0,76 - 4)	QS-47	301	4
13.2844.000...	9,52 (4 - 1,52 - 4)	QS-47	301	4
13.2811.000...	10,76 (5 - 0,76 - 5)	QS-47	301	4
13.2854.000...	11,52 (5 - 1,52 - 5)	QS-47	301	4
13.2813.000...	12,76 (6 - 0,76 - 6)	QS-47	301	4



International Design Model Protection

Tube

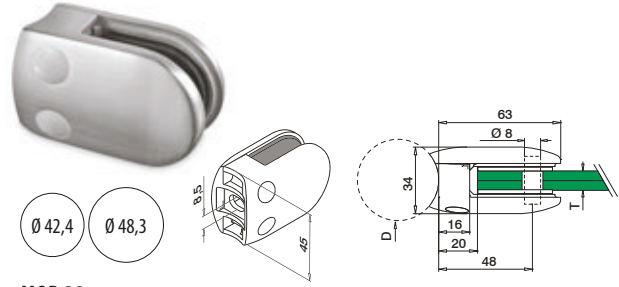

MOD 28



304				
INDOOR	D	T		
13.2806.042...	Ø 42,4	6	QS-47	301 4
13.2808.042...	Ø 42,4	8	QS-47	301 4
13.2810.042...	Ø 42,4	10	QS-47	301 4
13.2812.042...	Ø 42,4	12	QS-47	301 4
13.2806.048...	Ø 48,3	6	QS-47	301 4
13.2808.048...	Ø 48,3	8	QS-47	301 4
13.2810.048...	Ø 48,3	10	QS-47	301 4
13.2812.048...	Ø 48,3	12	QS-47	301 4



304				
INDOOR	D	T		
13.2807.042...	Ø 42,4	6,76 (3 - 0,76 - 3)	QS-47	301 4
13.2841.042...	Ø 42,4	8,38 (4 - 0,38 - 4)	QS-47	301 4
13.2809.042...	Ø 42,4	8,76 (4 - 0,76 - 4)	QS-47	301 4
13.2844.042...	Ø 42,4	9,52 (4 - 1,52 - 4)	QS-47	301 4
13.2811.042...	Ø 42,4	10,76 (5 - 0,76 - 5)	QS-47	301 4
13.2854.042...	Ø 42,4	11,52 (5 - 1,52 - 5)	QS-47	301 4
13.2813.042...	Ø 42,4	12,76 (6 - 0,76 - 6)	QS-47	301 4
13.2807.048...	Ø 48,3	6,76 (3 - 0,76 - 3)	QS-47	301 4
13.2841.048...	Ø 48,3	8,38 (4 - 0,38 - 4)	QS-47	301 4
13.2809.048...	Ø 48,3	8,76 (4 - 0,76 - 4)	QS-47	301 4
13.2844.048...	Ø 48,3	9,52 (4 - 1,52 - 4)	QS-47	301 4
13.2811.048...	Ø 48,3	10,76 (5 - 0,76 - 5)	QS-47	301 4
13.2854.048...	Ø 48,3	11,52 (5 - 1,52 - 5)	QS-47	301 4
13.2813.048...	Ø 48,3	12,76 (6 - 0,76 - 6)	QS-47	301 4



International Design Model Protection

Flat + tube

Q-INFO

304

MOD 28 Finishes

Satin

Polished



13.28.....12

13.28.....10

Flat

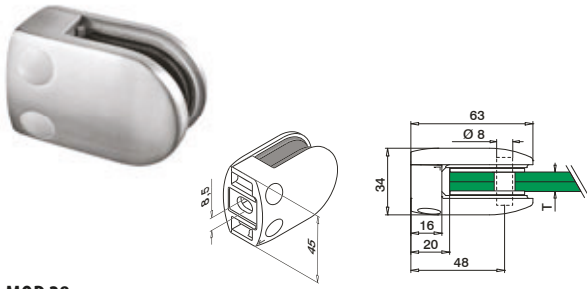

Tube

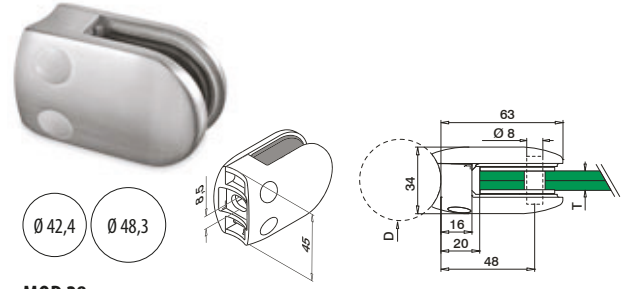

MOD 28

MONO		316	T		
		OUTDOOR			
14.2806.000...			6	QS-45	301
14.2808.000...			8	QS-45	301
14.2810.000...			10	QS-45	301
14.2812.000...			12	QS-45	301

LAM.		316	T		
		OUTDOOR			
14.2807.000...	6,76 (3 - 0,76 - 3)			QS-45	301
14.2841.000...	8,38 (4 - 0,38 - 4)			QS-45	301
14.2809.000...	8,76 (4 - 0,76 - 4)			QS-45	301
14.2844.000...	9,52 (4 - 1,52 - 4)			QS-45	301
14.2811.000...	10,76 (5 - 0,76 - 5)			QS-45	301
14.2854.000...	11,52 (5 - 1,52 - 5)			QS-45	301
14.2813.000...	12,76 (6 - 0,76 - 6)			QS-45	301

MOD 28

MONO		316	D	T		
		OUTDOOR				
14.2806.042...			Ø 42,4	6	QS-45	301
14.2808.042...			Ø 42,4	8	QS-45	301
14.2810.042...			Ø 42,4	10	QS-45	301
14.2812.042...			Ø 42,4	12	QS-45	301
14.2806.048...			Ø 48,3	6	QS-45	301
14.2808.048...			Ø 48,3	8	QS-45	301
14.2810.048...			Ø 48,3	10	QS-45	301
14.2812.048...			Ø 48,3	12	QS-45	301

LAM.		316	D	T		
		OUTDOOR				
14.2807.042...	Ø 42,4	6,76 (3 - 0,76 - 3)		QS-45	301	4
14.2841.042...	Ø 42,4	8,38 (4 - 0,38 - 4)		QS-45	301	4
14.2809.042...	Ø 42,4	8,76 (4 - 0,76 - 4)		QS-45	301	4
14.2844.042...	Ø 42,4	9,52 (4 - 1,52 - 4)		QS-45	301	4
14.2811.042...	Ø 42,4	10,76 (5 - 0,76 - 5)		QS-45	301	4
14.2854.042...	Ø 42,4	11,52 (5 - 1,52 - 5)		QS-45	301	4
14.2813.042...	Ø 42,4	12,76 (6 - 0,76 - 6)		QS-45	301	4
14.2807.048...	Ø 48,3	6,76 (3 - 0,76 - 3)		QS-45	301	4
14.2841.048...	Ø 48,3	8,38 (4 - 0,38 - 4)		QS-45	301	4
14.2809.048...	Ø 48,3	8,76 (4 - 0,76 - 4)		QS-45	301	4
14.2844.048...	Ø 48,3	9,52 (4 - 1,52 - 4)		QS-45	301	4
14.2811.048...	Ø 48,3	10,76 (5 - 0,76 - 5)		QS-45	301	4
14.2854.048...	Ø 48,3	11,52 (5 - 1,52 - 5)		QS-45	301	4
14.2813.048...	Ø 48,3	12,76 (6 - 0,76 - 6)		QS-45	301	4



International Design Model Protection



International Design Model Protection

Flat + tube

Q-INFO 316 MOD 28 Finishes

Satin



14.28.....12

Polished



14.28.....10

Please order security pins and fixing bolts separately.

Q-INFO MOD 5015

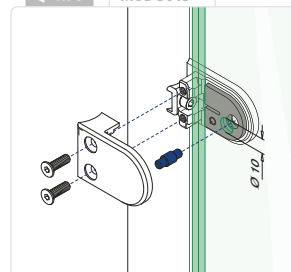

Glass clamps - MOD 28

Flat

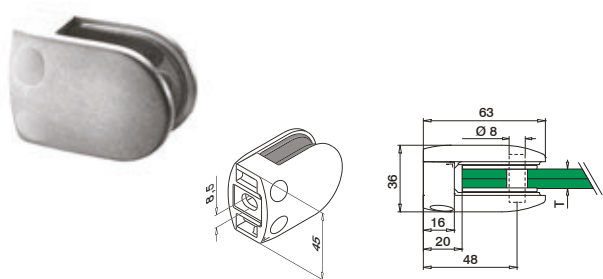

MOD 28



Zinc				
INDOOR	T			
10.2806.000...	6	QS-46	301	4
10.2808.000...	8	QS-46	301	4
10.2810.000...	10	QS-46	301	4
10.2812.000...	12	QS-46	301	4



Zinc				
INDOOR	T			
10.2807.000...	6,76 (3 - 0,76 - 3)	QS-46	301	4
10.2841.000...	8,38 (4 - 0,38 - 4)	QS-46	301	4
10.2809.000...	8,76 (4 - 0,76 - 4)	QS-46	301	4
10.2844.000...	9,52 (4 - 1,52 - 4)	QS-46	301	4
10.2811.000...	10,76 (5 - 0,76 - 5)	QS-46	301	4
10.2854.000...	11,52 (5 - 1,52 - 5)	QS-46	301	4
10.2813.000...	12,76 (6 - 0,76 - 6)	QS-46	301	4



International Design Model Protection

Tube

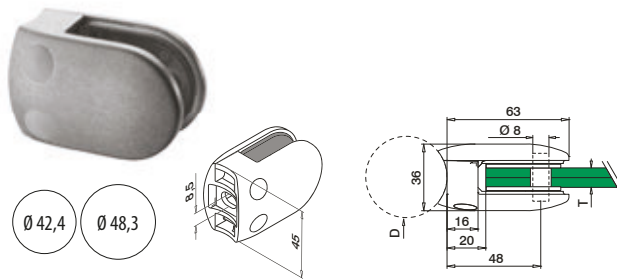

MOD 28



Zinc				
INDOOR	D	T		
10.2806.042...	Ø 42,4	6	QS-46	301 4
10.2808.042...	Ø 42,4	8	QS-46	301 4
10.2810.042...	Ø 42,4	10	QS-46	301 4
10.2812.042...	Ø 42,4	12	QS-46	301 4
10.2806.048...	Ø 48,3	6	QS-46	301 4
10.2808.048...	Ø 48,3	8	QS-46	301 4
10.2810.048...	Ø 48,3	10	QS-46	301 4
10.2812.048...	Ø 48,3	12	QS-46	301 4



Zinc				
INDOOR	D	T		
10.2807.042...	Ø 42,4	6,76 (3 - 0,76 - 3)	QS-46	301 4
10.2841.042...	Ø 42,4	8,38 (4 - 0,38 - 4)	QS-46	301 4
10.2809.042...	Ø 42,4	8,76 (4 - 0,76 - 4)	QS-46	301 4
10.2844.042...	Ø 42,4	9,52 (4 - 1,52 - 4)	QS-46	301 4
10.2811.042...	Ø 42,4	10,76 (5 - 0,76 - 5)	QS-46	301 4
10.2854.042...	Ø 42,4	11,52 (5 - 1,52 - 5)	QS-46	301 4
10.2813.042...	Ø 42,4	12,76 (6 - 0,76 - 6)	QS-46	301 4
10.2807.048...	Ø 48,3	6,76 (3 - 0,76 - 3)	QS-46	301 4
10.2841.048...	Ø 48,3	8,38 (4 - 0,38 - 4)	QS-46	301 4
10.2809.048...	Ø 48,3	8,76 (4 - 0,76 - 4)	QS-46	301 4
10.2844.048...	Ø 48,3	9,52 (4 - 1,52 - 4)	QS-46	301 4
10.2811.048...	Ø 48,3	10,76 (5 - 0,76 - 5)	QS-46	301 4
10.2854.048...	Ø 48,3	11,52 (5 - 1,52 - 5)	QS-46	301 4
10.2813.048...	Ø 48,3	12,76 (6 - 0,76 - 6)	QS-46	301 4



International Design Model Protection

Flat

Q-INFO

Zinc

MOD 28 Finishes

Raw

Matt chrome

Chrome plated

Stainless steel effect



10.28.....00



10.28.....16



10.28.....17



10.28.....19

Black RAL 9005



10.28.....31

White RAL 9016



10.28.....32

Aluminium white RAL 9006



10.28.....36

Please order security pins and fixing bolts separately.

Tube

Q-INFO

Zinc

MOD 28 Finishes

Raw

Chrome plated

Stainless steel effect



10.28.....00



10.28.....17



10.28.....19

Glass clamps - MOD 44/46

Tube + flat

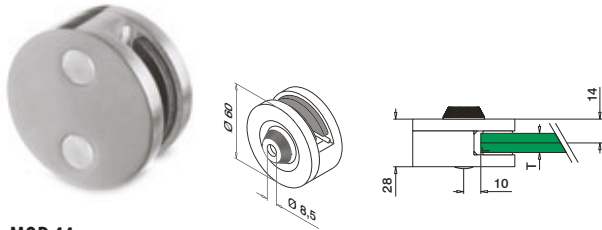

MOD 44

MONO	304	INDOOR	T	Ø 8,5	301	4
		13.4408.000.12	8	ØS-47	301	4
		13.4410.000.12	10	ØS-47	301	4
		13.4412.000.12	12	ØS-47	301	4

LAM.	304	INDOOR	T	Ø 8,5	301	4
		13.4409.000.12	8,76 (4 - 0,76 - 4)	ØS-47	301	4
		13.4411.000.12	10,76 (5 - 0,76 - 5)	ØS-47	301	4
		13.4413.000.12	12,76 (6 - 0,76 - 6)	ØS-47	301	4

MONO	316	OUTDOOR	T	Ø 8,5	301	4
		14.4408.000.12	8	ØS-45	301	4
		14.4410.000.12	10	ØS-45	301	4
		14.4412.000.12	12	ØS-45	301	4

LAM.	316	OUTDOOR	T	Ø 8,5	301	4
		14.4409.000.12	8,76 (4 - 0,76 - 4)	ØS-45	301	4
		14.4411.000.12	10,76 (5 - 0,76 - 5)	ØS-45	301	4
		14.4413.000.12	12,76 (6 - 0,76 - 6)	ØS-45	301	4



Tube + flat

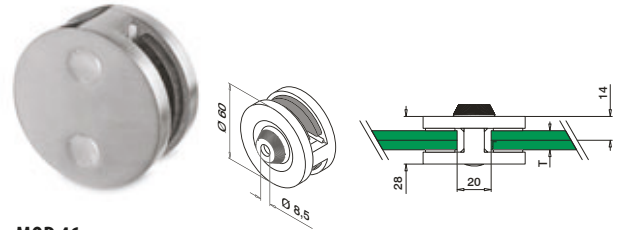

MOD 46

MONO	304	INDOOR	T	Ø 8,5	301	4
		13.4608.000.12	8	ØS-47	301	4
		13.4610.000.12	10	ØS-47	301	4
		13.4612.000.12	12	ØS-47	301	4

LAM.	304	INDOOR	T	Ø 8,5	301	4
		13.4609.000.12	8,76 (4 - 0,76 - 4)	ØS-47	301	4
		13.4611.000.12	10,76 (5 - 0,76 - 5)	ØS-47	301	4
		13.4613.000.12	12,76 (6 - 0,76 - 6)	ØS-47	301	4

MONO	316	OUTDOOR	T	Ø 8,5	301	4
		14.4608.000.12	8	ØS-45	301	4
		14.4610.000.12	10	ØS-45	301	4
		14.4612.000.12	12	ØS-45	301	4

LAM.	316	OUTDOOR	T	Ø 8,5	301	4
		14.4609.000.12	8,76 (4 - 0,76 - 4)	ØS-45	301	4
		14.4611.000.12	10,76 (5 - 0,76 - 5)	ØS-45	301	4
		14.4613.000.12	12,76 (6 - 0,76 - 6)	ØS-45	301	4



Adapters for glass clamps

Flat



MOD 0723

MONO	304	INDOOR	D	301	4
		13.0723.000.12		301	4

MONO	316	OUTDOOR	D	301	4
		14.0723.000.12		301	4

Tube



MOD 0723

MONO	304	INDOOR	D	301	4
		13.0723.042.12	Ø 42,4	301	4
		13.0723.048.12	Ø 48,3	301	4

MONO	316	OUTDOOR	D	301	4
		14.0723.042.12	Ø 42,4	301	4
		14.0723.048.12	Ø 48,3	301	4

Glass clamps - MOD 44/46

Tube + flat

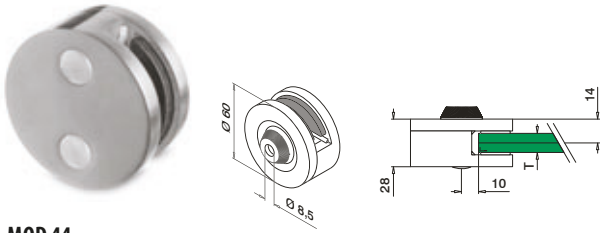

MOD 44

MONO	Zinc	Stainless steel effect		
	OUTDOOR	T		
10.4408.000.20	8	QS-45	301	4
10.4410.000.20	10	QS-45	301	4
10.4412.000.20	12	QS-45	301	4

LAM.	Zinc	Stainless steel effect		
	OUTDOOR	T		
10.4409.000.20	8,76 (4 - 0,76 - 4)	QS-45	301	4
10.4411.000.20	10,76 (5 - 0,76 - 5)	QS-45	301	4
10.4413.000.20	12,76 (6 - 0,76 - 6)	QS-45	301	4



Tube + flat

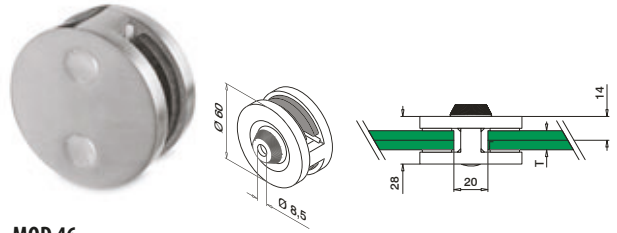

MOD 46

MONO	Zinc	Stainless steel effect		
	OUTDOOR	T		
10.4608.000.20	8	QS-45	301	4
10.4610.000.20	10	QS-45	301	4
10.4612.000.20	12	QS-45	301	4

LAM.	Zinc	Stainless steel effect		
	OUTDOOR	T		
10.4609.000.20	8,76 (4 - 0,76 - 4)	QS-45	301	4
10.4611.000.20	10,76 (5 - 0,76 - 5)	QS-45	301	4
10.4613.000.20	12,76 (6 - 0,76 - 6)	QS-45	301	4



Adapters for glass clamps

Flat



MOD 0723

MONO	Zinc	Stainless steel effect	
	OUTDOOR		
10.0723.000.20			4

Tube



MOD 0723

MONO	Zinc	Stainless steel effect	
	OUTDOOR	D	
10.0723.042.20		Ø 42,4	4
10.0723.048.20		Ø 48,3	4

Please order fixing bolts separately.

Q-INFO

10.xxxx.xxx.20 = outdoor

Q-INFO

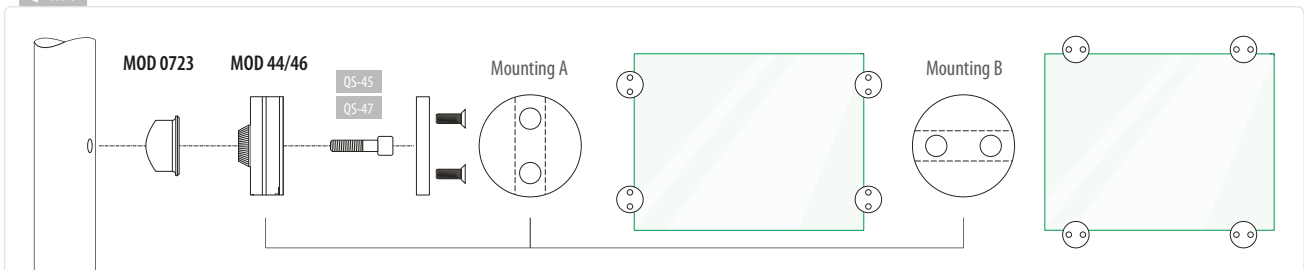

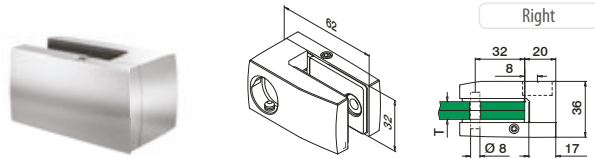

Right

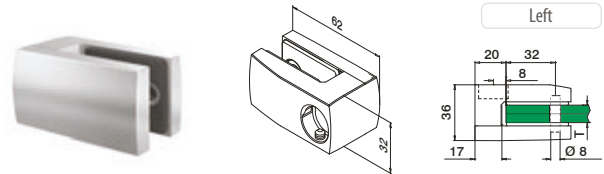

Left

MOD 29



316

OUTDOOR

T



14.2908.001.12	8	2
14.2910.001.12	10	2
14.2912.001.12	12	2



316

OUTDOOR

T



14.2909.001.12	8,76 (4 - 0,76 - 4)	2
14.2944.001.12	9,52 (4 - 1,52 - 4)	2
14.2911.001.12	10,76 (5 - 0,76 - 5)	2
14.2954.001.12	11,52 (5 - 1,52 - 5)	2
14.2913.001.12	12,76 (6 - 0,76 - 6)	2
14.2964.001.12	13,52 (6 - 1,52 - 6)	2

NEW

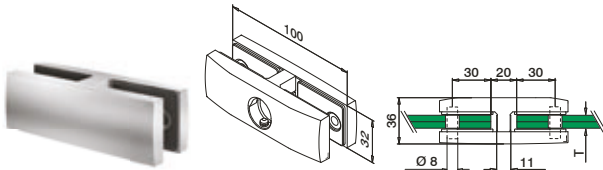

MOD 29



316

OUTDOOR

T



14.2908.000.12	8	4
14.2910.000.12	10	4
14.2912.000.12	12	4



316

OUTDOOR

T



14.2909.000.12	8,76 (4 - 0,76 - 4)	4
14.2944.000.12	9,52 (4 - 1,52 - 4)	4
14.2911.000.12	10,76 (5 - 0,76 - 5)	4
14.2954.000.12	11,52 (5 - 1,52 - 5)	4
14.2913.000.12	12,76 (6 - 0,76 - 6)	4
14.2964.000.12	13,52 (6 - 1,52 - 6)	4

NEW



Accessories

Security pins for glass clamps

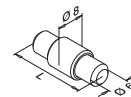

Security pins for glass clamps

MOD 5015

Accessories

	L	
19.5015.022.00	22	4



For flat tube

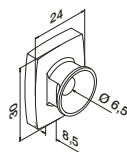

MOD 0774

316

OUTDOOR



14.0774.000.12	05-16	303	4
----------------	-------	-----	---

NEW



For round tube

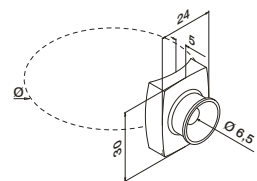

MOD 0774

316

OUTDOOR

Ø



14.0774.042.12	42,4	05-16	303	4
14.0774.048.12	48,3	05-16	303	4

NEW



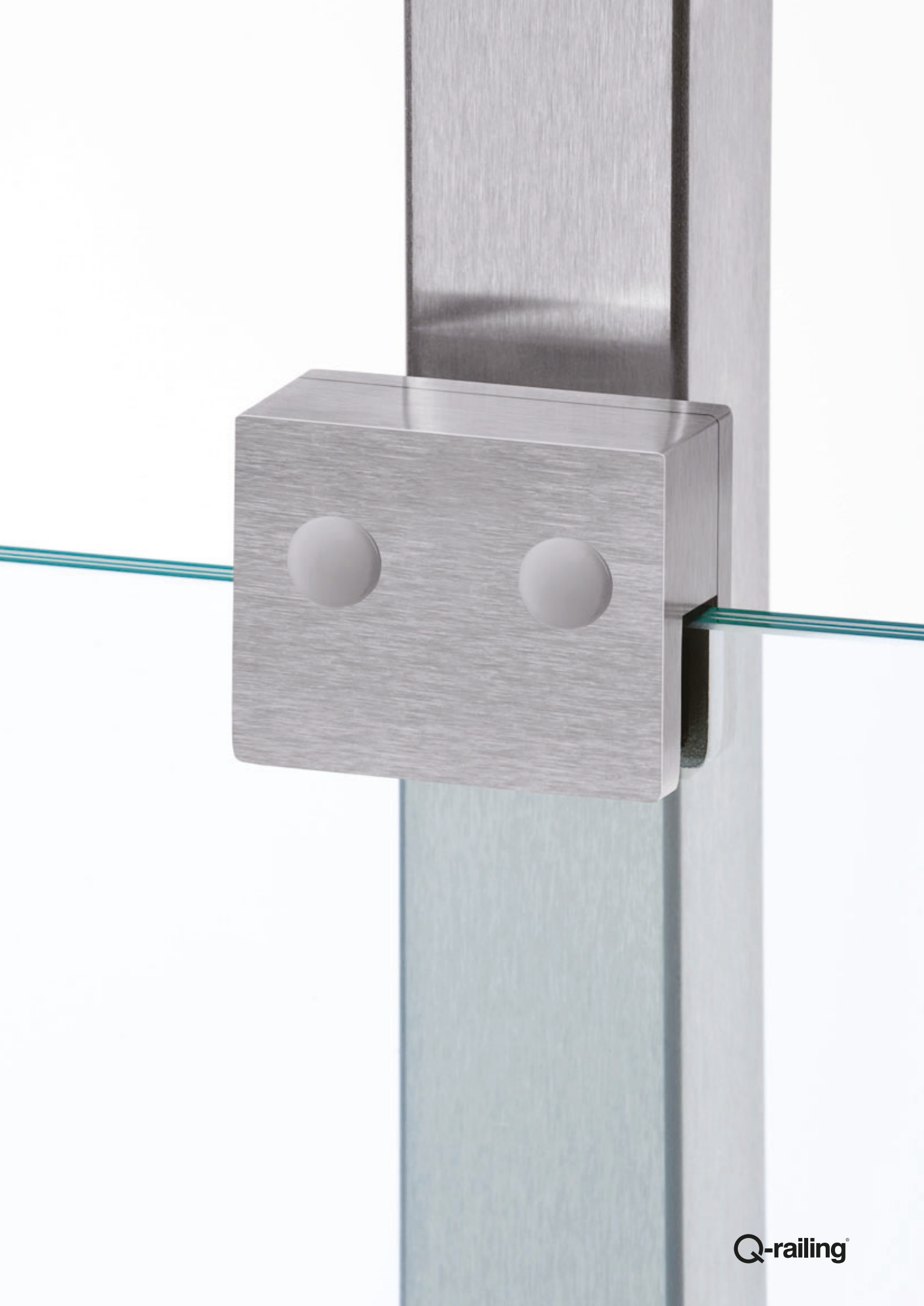

Glass clamps

Tube + flat

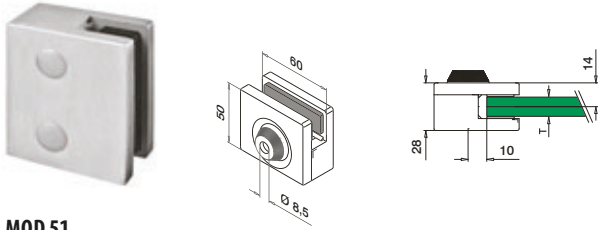

MOD 51

MONO	304	INDOOR	T		
		13.5108.000.12	8	QS-47	301 4
		13.5110.000.12	10	QS-47	301 4
		13.5112.000.12	12	QS-47	301 4

LAM.	304	INDOOR	T		
		13.5109.000.12	8,76 (4 - 0,76 - 4)	QS-47	301 4
		13.5111.000.12	10,76 (5 - 0,76 - 5)	QS-47	301 4
		13.5113.000.12	12,76 (6 - 0,76 - 6)	QS-47	301 4

MOD 51

MONO	316	OUTDOOR	T		
		14.5108.000.12	8	QS-45	301 4
		14.5110.000.12	10	QS-45	301 4
		14.5112.000.12	12	QS-45	301 4

LAM.	316	OUTDOOR	T		
		14.5109.000.12	8,76 (4 - 0,76 - 4)	QS-45	301 4
		14.5111.000.12	10,76 (5 - 0,76 - 5)	QS-45	301 4
		14.5113.000.12	12,76 (6 - 0,76 - 6)	QS-45	301 4



Tube + flat

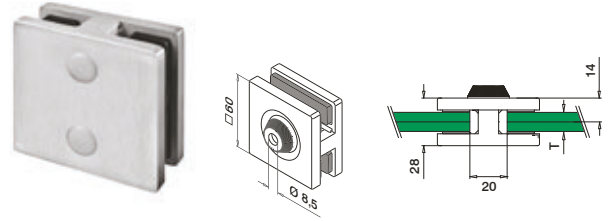

MOD 52

MONO	304	INDOOR	T		
		13.5208.000.12	8	QS-47	301 4
		13.5210.000.12	10	QS-47	301 4
		13.5212.000.12	12	QS-47	301 4

LAM.	304	INDOOR	T		
		13.5209.000.12	8,76 (4 - 0,76 - 4)	QS-47	301 4
		13.5211.000.12	10,76 (5 - 0,76 - 5)	QS-47	301 4
		13.5213.000.12	12,76 (6 - 0,76 - 6)	QS-47	301 4

MOD 52

MONO	316	OUTDOOR	T		
		14.5208.000.12	8	QS-45	301 4
		14.5210.000.12	10	QS-45	301 4
		14.5212.000.12	12	QS-45	301 4

LAM.	316	OUTDOOR	T		
		14.5209.000.12	8,76 (4 - 0,76 - 4)	QS-45	301 4
		14.5211.000.12	10,76 (5 - 0,76 - 5)	QS-45	301 4
		14.5213.000.12	12,76 (6 - 0,76 - 6)	QS-45	301 4



Adapters for glass clamps

Flat



MOD 0723

MONO	304	INDOOR	D		
		13.0723.000.12			4

LAM.	316	OUTDOOR	D		
		14.0723.000.12			4

Tube



MOD 0723

MONO	304	INDOOR	D		
		13.0723.042.12	Ø 42,4		4
		13.0723.048.12	Ø 48,3		4

LAM.	316	OUTDOOR	D		
		14.0723.042.12	Ø 42,4		4
		14.0723.048.12	Ø 48,3		4

Please order fixing bolts separately.

Q-INFO

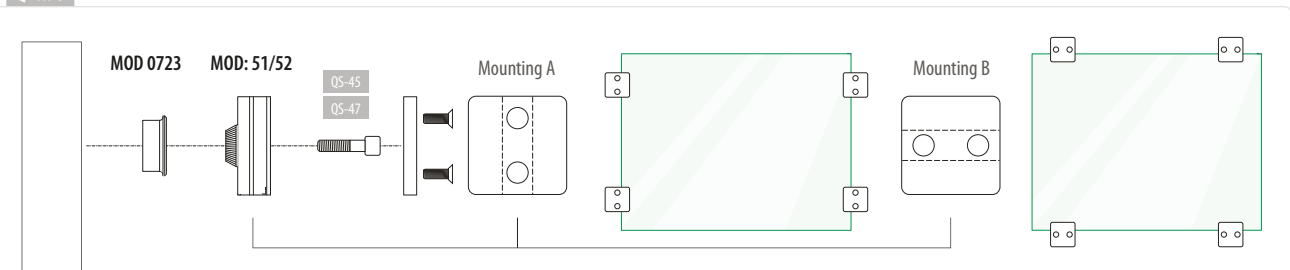

Top

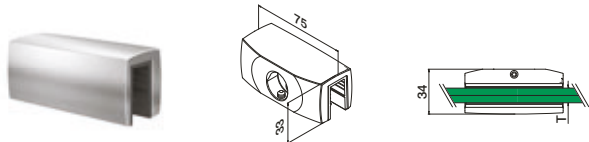

MOD 55

316

OUTDOOR	T	
14.5508.001.12	8 - 8,76 (4 - 0,76 - 4)	2
14.5544.001.12	9,52 (4 - 1,52 - 4)	2
14.5510.001.12	10 - 10,76 (5 - 0,76 - 5)	2
14.5554.001.12	11,52 (5 - 1,52 - 5)	2
14.5512.001.12	12 - 12,76 (6 - 0,76 - 6)	2
14.5564.001.12	13,52 (6 - 1,52 - 6)	2

NEW



Bottom

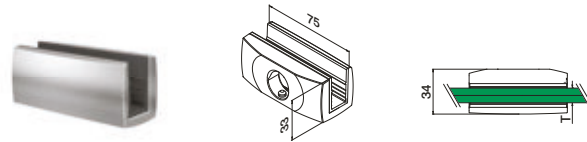

MOD 55

316

OUTDOOR	T	
14.5508.002.12	8 - 8,76 (4 - 0,76 - 4)	2
14.5544.002.12	9,52 (4 - 1,52 - 4)	2
14.5510.002.12	10 - 10,76 (5 - 0,76 - 5)	2
14.5554.002.12	11,52 (5 - 1,52 - 5)	2
14.5512.002.12	12 - 12,76 (6 - 0,76 - 6)	2
14.5564.002.12	13,52 (6 - 1,52 - 6)	2

NEW



For flat tube



MOD 0774

316

OUTDOOR		
14.0774.000.12	QS-16 303	4

NEW



For round tube

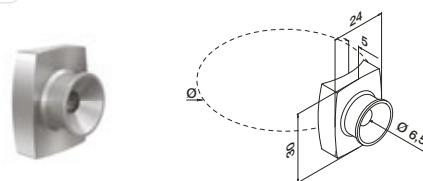

MOD 0774

316

OUTDOOR	Ø	
14.0774.042.12	42,4	QS-16 303 4
14.0774.048.12	48,3	QS-16 303 4

NEW



Q-INFO

MOD 0774

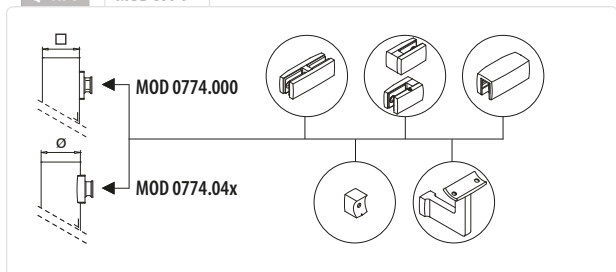

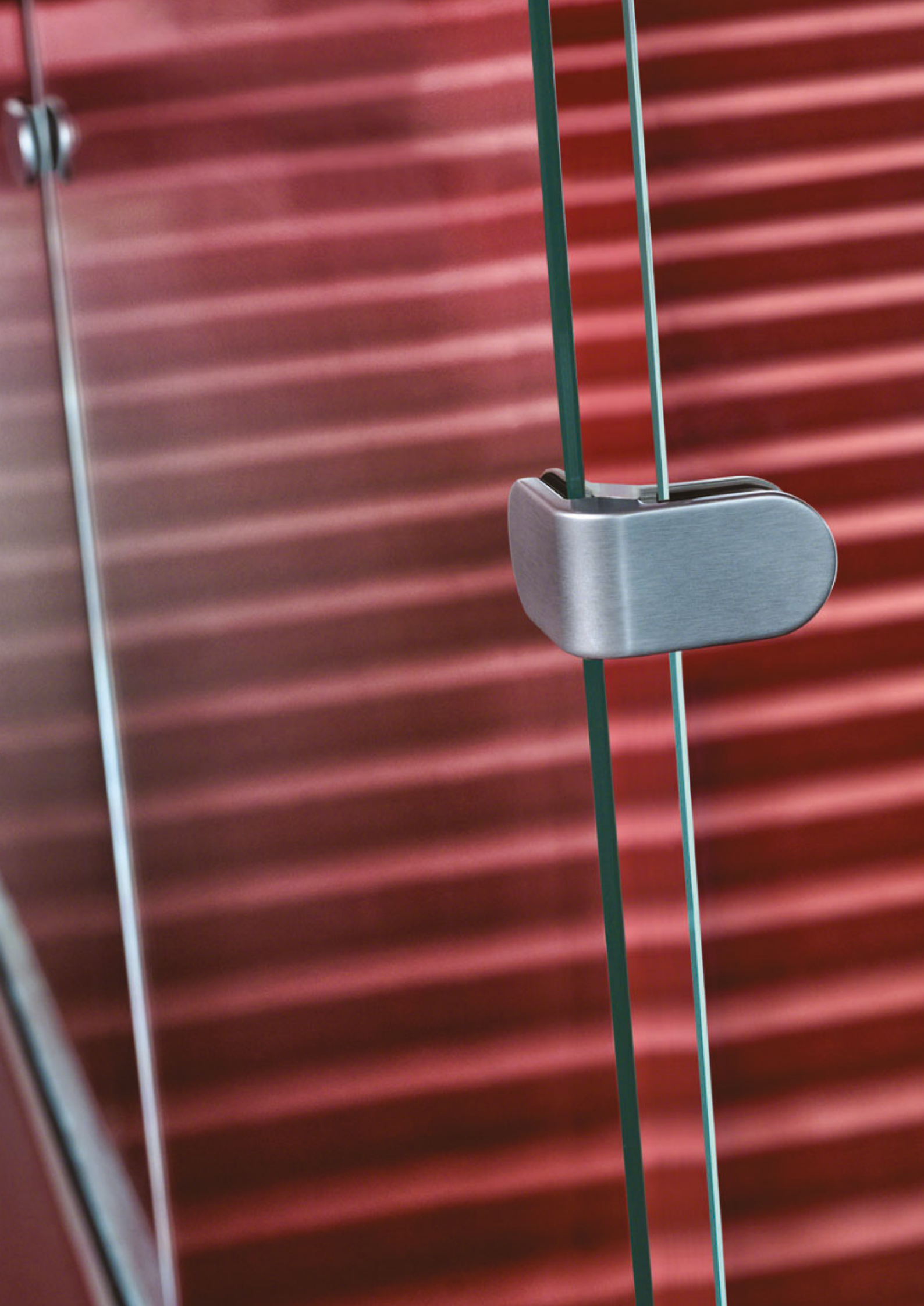

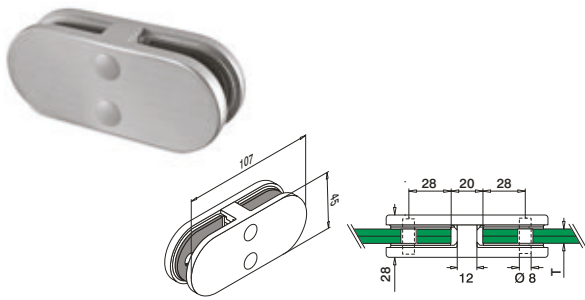

MOD 22

304			
MONO	INDOOR	T	
	13.2206.700.12	6	2
	13.2208.700.12	8	2
	13.2210.700.12	10	2

304			
LAM.	INDOOR	T	
	13.2207.700.12	6,76 (3 - 0,76 - 3)	2
	13.2241.700.12	8,38 (4 - 0,38 - 4)	2
	13.2209.700.12	8,76 (4 - 0,76 - 4)	2
	13.2244.700.12	9,52 (4 - 1,52 - 4)	2

316			
MONO	OUTDOOR	T	
	14.2206.700.12	6	2
	14.2208.700.12	8	2
	14.2210.700.12	10	2

316			
LAM.	OUTDOOR	T	
	14.2207.700.12	6,76 (3 - 0,76 - 3)	2
	14.2241.700.12	8,38 (4 - 0,38 - 4)	2
	14.2209.700.12	8,76 (4 - 0,76 - 4)	2
	14.2244.700.12	9,52 (4 - 1,52 - 4)	2

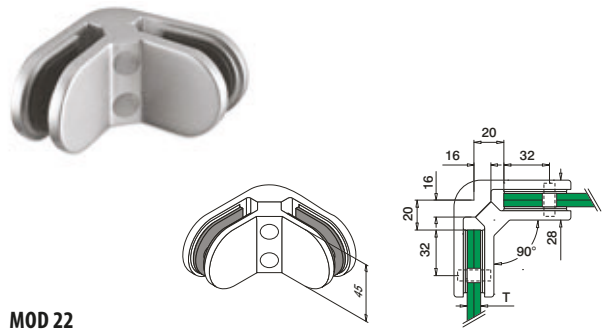

MOD 22

304			
MONO	INDOOR	T	
	13.2206.900.12	6	2
	13.2208.900.12	8	2
	13.2210.900.12	10	2

304			
LAM.	INDOOR	T	
	13.2207.900.12	6,76 (3 - 0,76 - 3)	2
	13.2241.900.12	8,38 (4 - 0,38 - 4)	2
	13.2209.900.12	8,76 (4 - 0,76 - 4)	2
	13.2244.900.12	9,52 (4 - 1,52 - 4)	2

316			
MONO	OUTDOOR	T	
	14.2206.900.12	6	2
	14.2208.900.12	8	2
	14.2210.900.12	10	2

316			
LAM.	OUTDOOR	T	
	14.2207.900.12	6,76 (3 - 0,76 - 3)	2
	14.2241.900.12	8,38 (4 - 0,38 - 4)	2
	14.2209.900.12	8,76 (4 - 0,76 - 4)	2
	14.2244.900.12	9,52 (4 - 1,52 - 4)	2



Q-INFO MOD 22xx.700

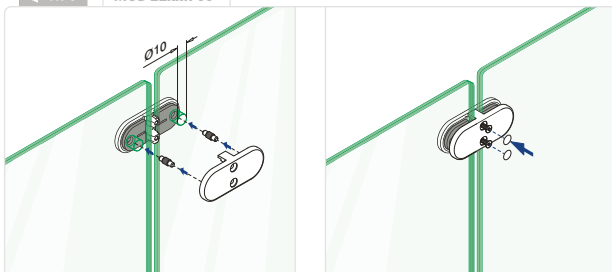

Q-INFO



Q-INFO



Q-INFO MOD 22xx.900

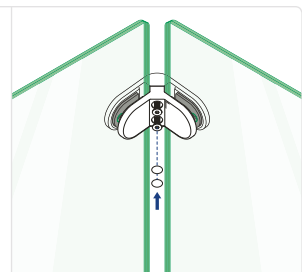
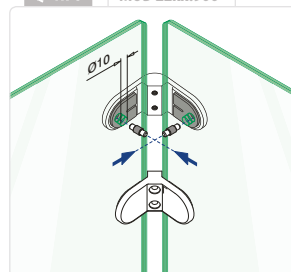

Glass - glass

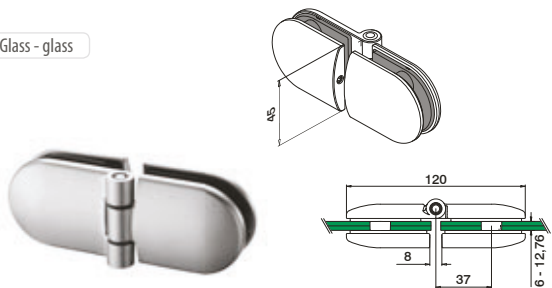

MOD 0281

316

OUTDOOR

14.0281.500.12



2



DESIGN
product

International Design Model Protection

Tube - glass

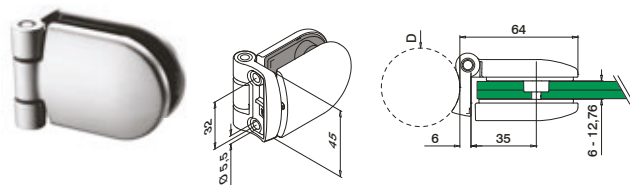

MOD 0281

316

OUTDOOR

14.0281.042.12

Ø 42,4



QS-13 303



2

14.0281.048.12

Ø 48,3

QS-13 303

2



DESIGN
product

International Design Model Protection

Q-INFO

MOD 0281.500

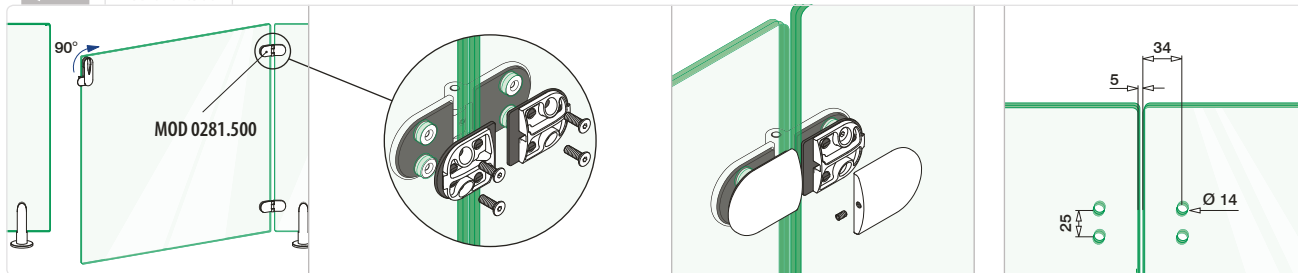

Q-INFO

MOD 0281.04x

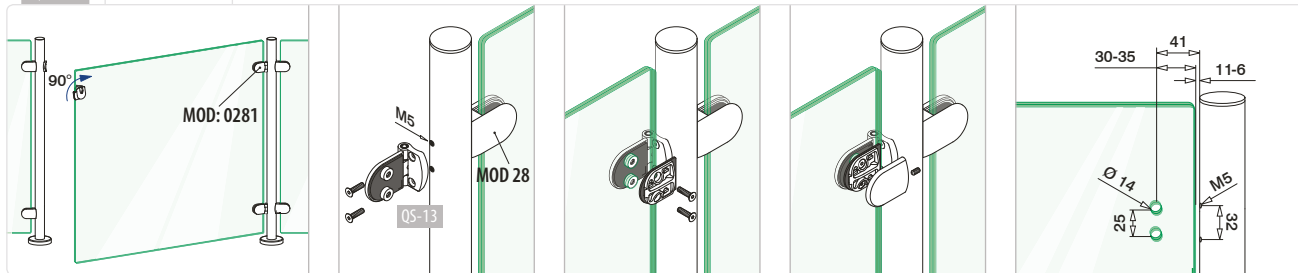

Glass - glass

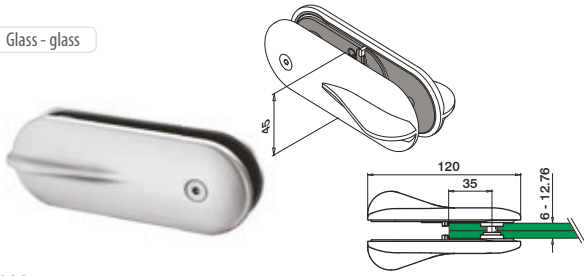

MOD 0282

316

OUTDOOR

14.0282.500.12



1



DESIGN product

International Design Model Protection

Tube - glass

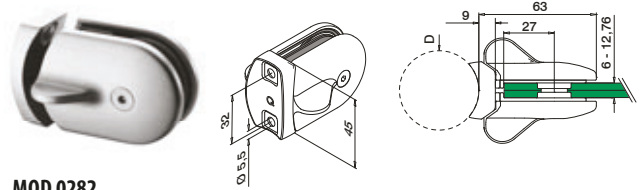

MOD 0282

316

OUTDOOR

14.0282.042.12

Ø 42,4

QS-13

303

1

14.0282.048.12

Ø 48,3

QS-13

303

1



DESIGN product

International Design Model Protection



Q-INFO MOD 0282.500

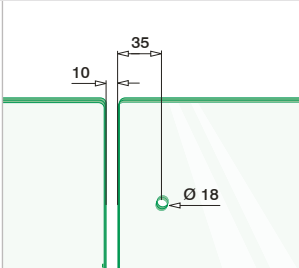
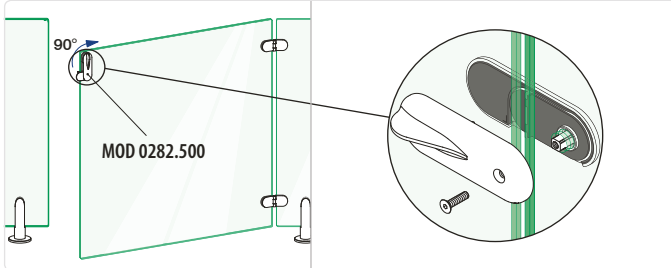

Q-INFO



Q-INFO MOD 0282.04x

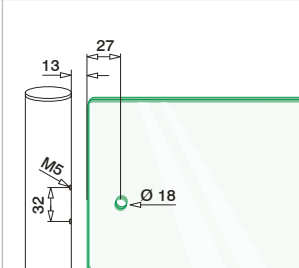
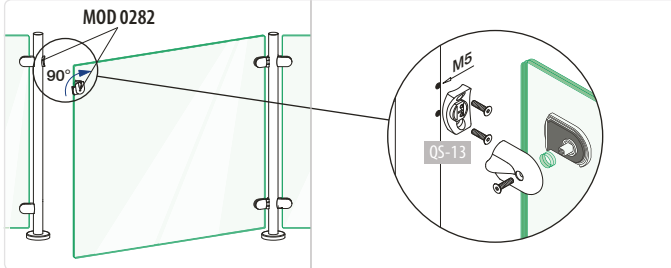

Q-INFO



Glass adapters - Spider

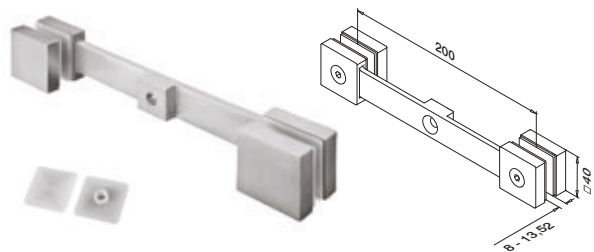

MOD 4752

304		
INDOOR		
13.4752.000.12	QS-19	303 2
316		
OUTDOOR		
14.4752.000.12	QS-20	303 2



International Design Model Protection

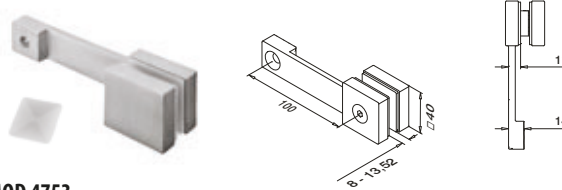

MOD 4753

304		
INDOOR		
13.4753.000.12	QS-19	303 2
316		
OUTDOOR		
14.4753.000.12	QS-20	303 2



International Design Model Protection

Q-INFO MOD 4752

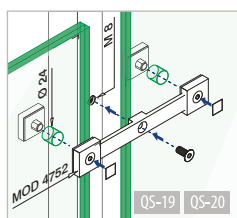

Q-INFO



Q-23
Q-cleaner
300 ml
19.0601.000.00



Glass adapters - Spider

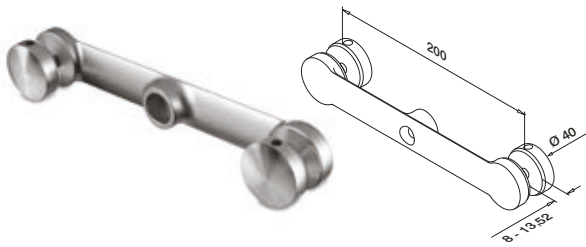

MOD 0752

304

INDOOR

13.0752.000.12	QS-21	303	2
----------------	-------	-----	---

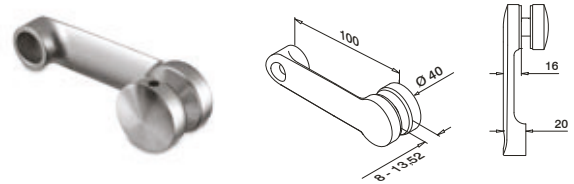

MOD 0753

304

INDOOR

13.0753.000.12	QS-21	303	2
----------------	-------	-----	---

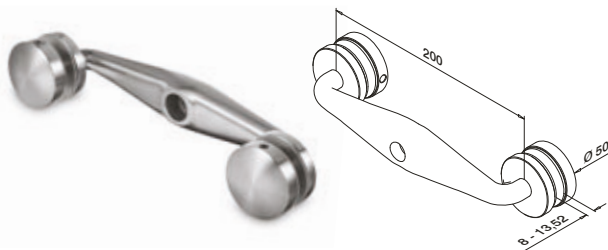

MOD 0750

304

INDOOR

13.0750.000.12	QS-31	303	2
----------------	-------	-----	---

316

OUTDOOR

14.0750.000.12	QS-72	303	2
----------------	-------	-----	---

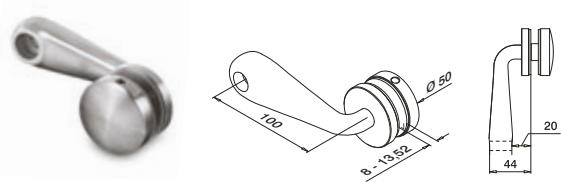

MOD 0751

304

INDOOR

13.0751.000.12	QS-31	303	2
----------------	-------	-----	---

316

OUTDOOR

14.0751.000.12	QS-72	303	2
----------------	-------	-----	---



Adapters for glass adapters - Spider

Flat



MOD 0724

304

INDOOR

13.0724.000.12			2
----------------	--	--	---

316

OUTDOOR

14.0724.000.12			2
----------------	--	--	---



Tube



MOD 0724

304

INDOOR

13.0724.042.12	D		2
----------------	---	--	---

13.0724.048.12	Ø 42,4		2
----------------	--------	--	---

13.0724.048.12	Ø 48,3		2
----------------	--------	--	---

316

OUTDOOR

14.0724.042.12	D		2
----------------	---	--	---

14.0724.048.12	Ø 42,4		2
----------------	--------	--	---

14.0724.048.12	Ø 48,3		2
----------------	--------	--	---



Please order fixing bolts separately.

Q-INFO

MOD 0752

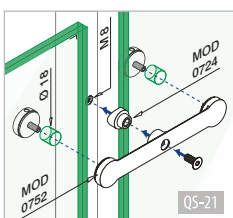

Q-INFO

MOD 0750

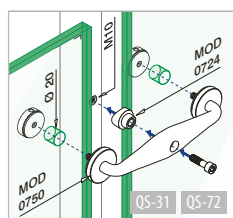

If you have a specific requirement for pre-assembled products please use our order forms on pages 324 - 336.

Glass adapters - Spider - Ø 30 mm

Flat - glass

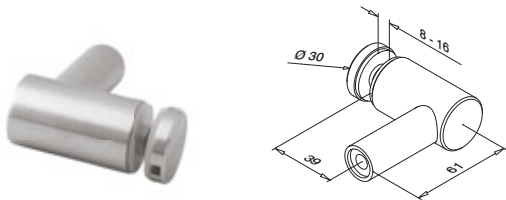

MOD 0754

316

OUTDOOR

14.0754.000.12



QS-30 303



4



International Design Model Protection

Tube - glass

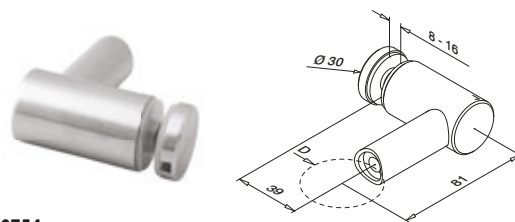

MOD 0754

316

OUTDOOR

14.0754.042.12

D

Ø 42,4



QS-30 303



4

14.0754.048.12

Ø 48,3

QS-30 303

4



International Design Model Protection



For more information, please visit our website: www.q-railing.com

Q-INFO

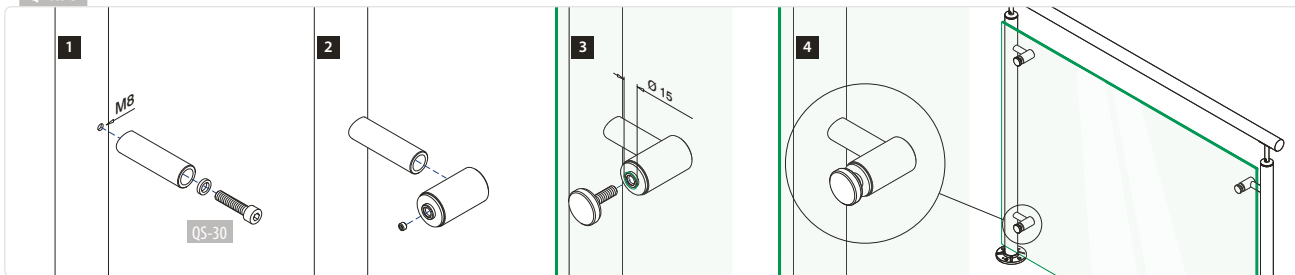

Flat - glass

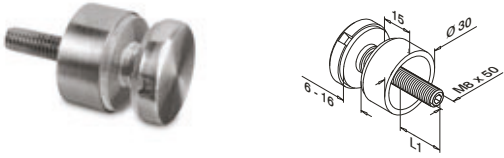

MOD 0746

304

INDOOR	L1	
13.0746.000.12	12 - 22	4

316

OUTDOOR	L1	
14.0746.000.12	12 - 22	4

Zinc

INDOOR	L1	
10.0746.000...	12 - 22	4



Flat - glass

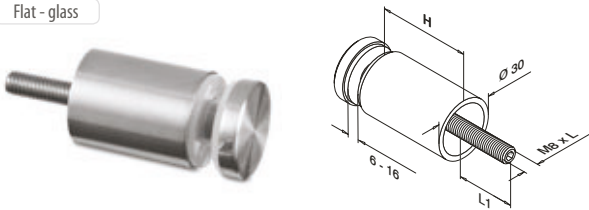

MOD 0746

304

INDOOR	H	L	L1	
13.0746.300.12	30	70	16 - 26	4
13.0746.400.12	40	80	16 - 26	4
13.0746.500.12	50	90	16 - 26	4



Flat - glass

Q-INFO

Zinc

MOD 0746.000 Finishes

Raw



10.0746.....00

Matt chrome



10.0746.....16

Stainless steel effect



10.0746.....19

Black RAL 9005



10.0746.....31

White RAL 9016



10.0746.....32

Aluminium white RAL 9006



10.0746.....36

Tube - glass

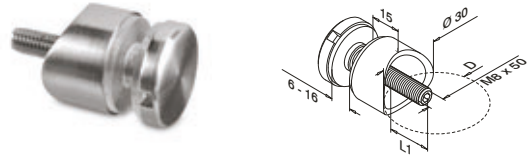

MOD 0746

304

INDOOR	D	L1	
13.0746.033.12	Ø 33,7	12 - 22	4
13.0746.042.12	Ø 42,4	12 - 22	4
13.0746.048.12	Ø 48,3	12 - 22	4

316

OUTDOOR	D	L1	
14.0746.033.12	Ø 33,7	12 - 22	4
14.0746.042.12	Ø 42,4	12 - 22	4
14.0746.048.12	Ø 48,3	12 - 22	4
14.0746.060.12	Ø 60,3	12 - 22	4

Zinc

INDOOR	D	L1	
10.0746.033...	Ø 33,7	12 - 22	4
10.0746.042...	Ø 42,4	12 - 22	4



MOD 0740

304

INDOOR	
13.0740.000.12	4

316

OUTDOOR	
14.0740.000.12	4



Tube - glass

Q-INFO

MOD 0746

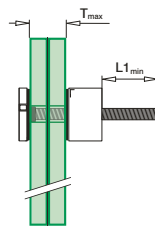

Q-INFO

MOD 0746.0xx

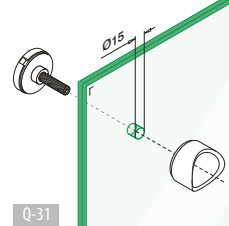

Q-INFO

Zinc

MOD 0746.0xx Finishes

Raw



10.0746.....00

Stainless steel effect



10.0746.....19

Infills

SATIN

Glass adapters - Ø 25 mm

Glass - bar

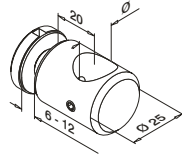

MOD 0746 - Ø 25 mm

304			
INDOOR	Ø		
13.0746.016.12	16		4
316			
OUTDOOR	Ø		
14.0746.012.12	12		4
14.0746.016.12	16		4



Infills

SATIN

Glass adapters - Ø 50 mm

Flat - glass

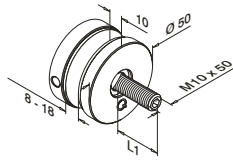

MOD 0747

304			
INDOOR	L1		
13.0747.000.12	10 - 20		2
316			
OUTDOOR	L1		
14.0747.000.12	10 - 20		2
Zinc			
	L1		
10.0747.000...	10 - 20		2



Tube - glass

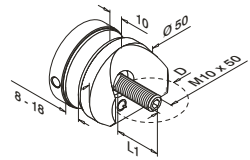

MOD 0747 - Ø 42,4 / Ø 48,3 mm

304			
INDOOR	D	L1	
13.0747.042.12	Ø 42,4	10 - 20	
13.0747.048.12	Ø 48,3	10 - 20	
316			
OUTDOOR	D	L1	
14.0747.042.12	Ø 42,4	10 - 20	



Flat - glass

Q-INFO

Zinc

MOD 0747.000 Finishes

Raw

Stainless steel effect

10.xxxxx.xxx.20 = OUTDOOR



10.0747.000.00



10.0747.000.20

Q-INFO

MOD 0746.016/0746.012

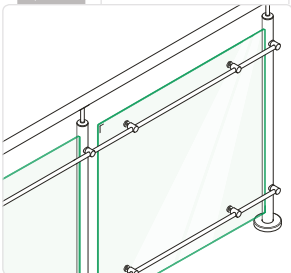

Q-INFO

MOD 0746.016/0746.012

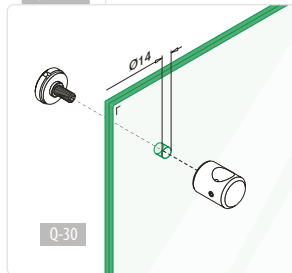

Q-INFO

MOD 0747.000

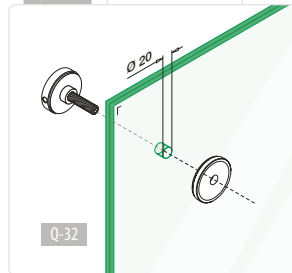

Q-INFO

MOD 0747.0xx

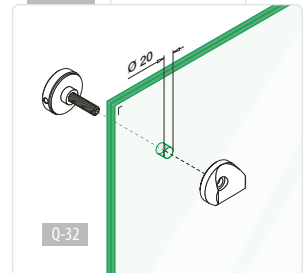



ACCESSORIES

4



THE ACCESSORIES YOU NEED FOR RAILING SYSTEM PERFECTION

You'll find all the essentials for easy installation right here, in the Q-railing catalogue. From cleaning aids to safety pins, drills to sawing benches; everything is immediately available, directly from stock.

Our tools and accessories are ergonomically designed and practical, giving the best possible finish and function. We also work with top brands like Fischer and 3M, who meet the same strict quality standards as the Q-railing range.

Displays

Use our displays to show your customers what their railing systems could look like. These allow you to create a quality scaled image of the final result, helping your customer make a well-considered choice.

Real-loc: tight is tight

Q-railing's screw connections are guaranteed tight - extremely tight! Our Real-loc screws are coated with a special nylon patch. Once the screw is locked, it will never shake loose.

The advantages for you:

- An even safer baluster railing
- No re-tighten
- A long-lasting (permanent) connection

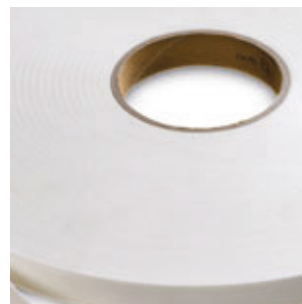

INDEX

ACCESSORIES



298 - 299
Rubber inlays
for glass clamps

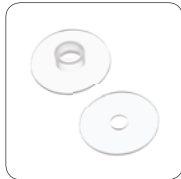

299
Rubber inlays
for glass adapters



299
Rubber inlays
for plate adapters



299
Cover caps
for screws



299
Security pins
for glass clamps
and plate adapters



301
Fixing materials
for glass clamps



302 - 305
Fixing materials
(screws etc.)



306 - 310
Fixing materials
for railing systems



311
Accessories
for railing systems



312
Consumable articles



313
Care and maintenance



314
Drilling and tapping



315 - 317
Tools



318 - 319
Displays



319 - 320
Promotion

Rubber inlays for glass clamps



Rubber inlays for all glass clamp models

MOD 50

Accessories

	For MOD	T	Pieces per glass clamp	
19.5000.006.00	20	6	2	8
19.5000.007.00	20	6,76 (3-0,76-3)	2	8
19.5000.008.00	20	8	2	8
19.5002.006.00	21	6	2	8
19.5002.007.00	21	6,76 (3-0,76-3)	2	8
19.5002.008.00	21	8	2	8
19.5002.009.00	21	8,76 (4-0,76-4)	2	8
19.5002.010.00	21	10	2	8
19.5002.044.00	21	9,52 (4-1,52-4)	2	8
19.5004.006.00	22	6	2	8
19.5004.007.00	22	6,76 (3-0,76-3)	2	8
19.5004.008.00	22	8	2	8
19.5004.041.00	22	8,38 (4-0,38-4)	2	8
19.5004.009.00	22	8,76 (4-0,76-4)	2	8
19.5004.010.00	22	10	2	8
19.5004.044.00	22	9,52 (4-1,52-4)	2	8
19.5007.012.00	24	12	2	8
19.5007.013.00	24	12,76 (6-0,76-6)	2	8
19.5007.015.00	24	15	2	8
19.5007.017.00	24	16,76 (8-0,76-8)	2	8
19.5007.018.00	24	17,52 (8-1,52-8)	2	8
19.5007.044.00	24	9,52 (4-1,52-4)	2	8
19.5007.054.00	24	11,52 (5-1,52-5)	2	8
19.5007.064.00	24	13,52 (6-1,52-6)	2	8
19.5012.009.00	27	8,76 (4-0,76-4)	2	8
19.5012.010.00	27	10	2	8
19.5012.011.00	27	10,76 (5-0,76-5)	2	8
19.5012.044.00	27	9,52 (4-1,52-4)	2	8
19.5001.006.00	28	6	2	8
19.5001.007.00	28	6,76 (3-0,76-3)	2	8
19.5001.008.00	28	8	2	8
19.5001.041.00	28	8,38 (4-0,38-4)	2	8
19.5001.009.00	28	8,76 (4-0,76-4)	2	8
19.5001.044.00	28	9,52 (4-1,52-4)	2	8
19.5001.010.00	28	10	2	8
19.5001.011.00	28	10,76 (5-0,76-5)	2	8
19.5001.054.00	28	11,52 (5-1,52-5)	2	8
19.5001.012.00	28	12	2	8
19.5001.013.00	28	12,76 (6-0,76-6)	2	8
19.5008.008.00	44 / 46	8	2 / 4	8
19.5008.009.00	44 / 46	8,76 (4-0,76-4)	2 / 4	8
19.5008.010.00	44 / 46	10	2 / 4	8
19.5008.011.00	44 / 46	10,76 (5-0,76-5)	2 / 4	8
19.5008.012.00	44 / 46	12	2 / 4	8
19.5008.013.00	44 / 46	12,76 (6-0,76-6)	2 / 4	8
19.5005.008.00	51 / 52	8	2 / 4	8
19.5005.009.00	51 / 52	8,76 (4-0,76-4)	2 / 4	8
19.5005.010.00	51 / 52	10	2 / 4	8
19.5005.011.00	51 / 52	10,76 (5-0,76-5)	2 / 4	8
19.5005.012.00	51 / 52	12	2 / 4	8
19.5005.013.00	51 / 52	12,76 (6-0,76-6)	2 / 4	8

MOD 50

	For MOD	T	Pieces per glass clamp	
19.5009.011.00	25	10,76 (5-0,76-5)	2	8
19.5009.012.00	25	12	2	8
19.5009.013.00	25	12,76 (6-0,76-6)	2	8
19.5009.054.00	25	11,52 (5-1,52-5)	2	8
19.5011.008.00	26	8	2	8
19.5011.009.00	26	8,76 (4-0,76-4)	2	8
19.5011.010.00	26	10	2	8
19.5011.011.00	26	10,76 (5-0,76-5)	2	8
19.5011.012.00	26	12	2	8
19.5011.013.00	26	12,76 (6-0,76-6)	2	8
19.5011.044.00	26	9,52 (4-1,52-4)	2	8
19.5011.054.00	26	11,52 (5-1,52-5)	2	8
NEW 19.5013.008.00	29	8	2/4	4
NEW 19.5013.009.00	29	8,76 (4-0,76-4)	2/4	4
NEW 19.5013.044.00	29	9,52 (4-1,52-4)	2/4	4
NEW 19.5013.010.00	29	10	2/4	4
NEW 19.5013.011.00	29	10,76 (5-0,76-5)	2/4	4
NEW 19.5013.054.00	29	11,52 (5-1,52-5)	2/4	4
NEW 19.5013.012.00	29	12	2/4	4
NEW 19.5013.013.00	29	12,76 (6-0,76-6)	2/4	4
NEW 19.5013.064.00	29	13,52 (6-1,52-6)	2/4	4
NEW 19.5014.008.00	55	8-8,76 (4-0,76-4)	1	2
NEW 19.5014.010.00	55	10-10,76 (5-0,76-5)	1	2
NEW 19.5014.012.00	55	12-12,76 (6-0,76-6)	1	2
NEW 19.5014.044.00	55	9,52 (4-1,52-4)	1	2
NEW 19.5014.054.00	55	11,52 (5-1,52-5)	1	2
NEW 19.5014.064.00	55	13,52 (6-1,52-6)	1	2
19.5062.012.00	6000	12	2	2
19.5062.013.00	6000	12,76 (6-0,76-6)	2	2
19.5062.014.00	6000	13,52 (6-1,52-6)	2	2
19.5062.015.00	6000	15	2	2
19.5062.017.00	6000	16,76 (8-0,76-8)	2	2
19.5062.018.00	6000	17,52 (8-1,52-8)	2	2
19.5063.012.00	61	12	2	2
19.5063.013.00	61	12,76 (6-0,76-6)	2	2
19.5063.014.00	61	13,52 (6-1,52-6)	2	2
19.5063.015.00	61	15	2	2
19.5063.017.00	61	16,76 (8-0,76-8)	2	2
19.5063.018.00	61	17,52 (8-1,52-8)	2	2
19.5064.012.00	62	12	2	2
19.5064.013.00	62	12,76 (6-0,76-6)	2	2
19.5064.014.00	62	13,52 (6-1,52-6)	2	2
19.5064.015.00	62	15	2	2
19.5064.017.00	62	16,76 (8-0,76-8)	2	2
19.5064.018.00	62	17,52 (8-1,52-8)	2	2

Rubber inlays for glass holders - MOD 55



MOD 5014

Accessories		
	T	
19.5014.008.00	8 - 8,76 (4 - 0,76 - 4)	4
19.5014.010.00	10 - 10,76 (5 - 0,76 - 5)	4
19.5014.012.00	12 - 12,76 (6 - 0,76 - 6)	4
19.5014.044.00	9,52 (4 - 1,52 - 4)	4
19.5014.054.00	11,52 (5 - 1,52 - 5)	4
19.5014.064.00	13,52 (6 - 1,52 - 6)	4

NEW

Rubber inlays for glass adapters

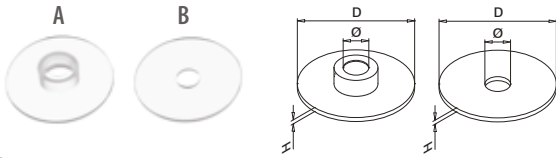

MOD 50

Accessories						
	For MOD	D	Ø	H	Pieces per glass adapter	
19.5032.050.00 A	0747 + 0750 + 0751 (Ø 50mm)	48	10	2	1	8
19.5031.050.00 B		48	10	2	1	8
19.5030.030.00 A	0746 + 0740 + 0754 (Ø 30 mm)	28	8	2	2	8
19.5030.025.00 A	0746 (Ø 25 mm)	24	6	1	1	8
19.5060.025.00 B		24	6	1	1	8
19.5030.050.00 A	0148 + 0117 + 9350 (Ø 50 mm)	48	8	2	2	8
19.5039.040.00 A	0752 + 0753	38	8	2	1	8
19.5038.040.00 B		38	8	2	1	8

Rubber inlays for plate adapters



Rubber inlays for plate adapters
(2 pieces per adapter)

MOD 50

Accessories			
	For MOD	T	
19.5001.002.00	2802	2	8
19.5001.003.00	2803	3	8
19.5001.004.00	2804	4	8

NEW

Cover caps



Nylon cover caps for lateral screws
(2 pieces per glass clamp)

MOD 5010

Accessories		
	Colour	
19.5010.000.00	Raw (grey)	8
19.5010.000.16	Matt chrome coloured	8
19.5010.000.17	Chrome coloured	8
19.5010.000.19	Stainless steel effect	8
19.5010.000.21	Gold coloured	8
19.5010.000.31	Black	8
19.5010.000.32	White	8
For MOD		
19.5010.060.19	Stainless steel effect	28 8

Cover caps for glass adapters - Spider

For MOD 4752 and 4753

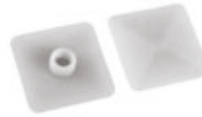

MOD 5010

Accessories			
	Colour	For MOD	
19.5010.004.19	Stainless steel effect	4752 / 4753	8

Security pins for glass clamps and plate adapters

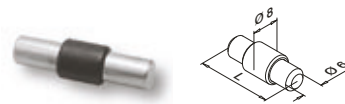



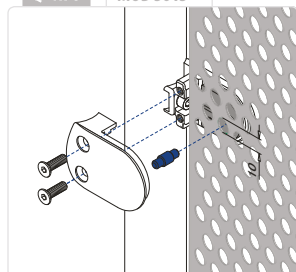
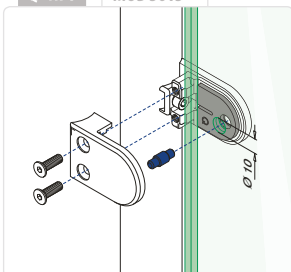

MOD 5015

Accessories			
	For MOD	L	
19.5015.022.00	22, 28, 29, 2802, 2803, 2804	22	4
19.5015.030.00	24, 6000	30	4
19.5015.025.00	25, 26	25	4
2205			
	For MOD	L	
19.5015.022.18	28	22	4



Q-screws overview

Order with more ease. A summary of pages 301-310.

QS				QS			
QS-1	95.0100.850.13	50	302	QS-73	19.4512.018.14	10	307
QS-2	93.0100.850.14	50	302	QS-74	95.0671.240.14	50	303
QS-3	93.0200.760.13	50	302	QS-75	19.4410.010.14	10	307
QS-4	93.0200.760.14	50	302	QS-80	93.0800.600.14	50	304
QS-5	93.0220.525.13	50	302	QS-81	93.0800.800.14	50	304
QS-6	93.0220.525.14	50	302	QS-82	93.0801.000.14	50	304
QS-7	93.0220.538.13	50	302	QS-83	95.0511.616.13	50	302
QS-8	93.0230.525.13	50	302	QS-84	95.0511.616.14	50	302
QS-9	93.0230.525.14	50	302	QS-85	95.0100.890.13	50	302
QS-10	95.0511.516.13	50	302	QS-86	95.0100.890.14	50	302
QS-11	95.0511.516.14	50	302	QS-87	93.0840.635.00	100	305
QS-12	95.0670.520.13	50	303	QS-88	19.4012.040.14	10	306
QS-13	95.0670.520.14	50	303	QS-89	95.0670.612.14	50	303
QS-14	95.0670.620.13	50	303	QS-90	95.0400.505.14	50	304
QS-15	95.0670.625.13	50	303	QS-91	95.0400.505.13	50	304
QS-16	95.0670.625.14	50	303	QS-92	95.0400.610.14	50	304
QS-17	95.0670.630.13	50	303	QS-93	95.0490.506.14	50	304
QS-18	95.0670.630.14	50	303	QS-94	95.0490.506.13	50	304
QS-19	95.0670.825.13	50	303	QS-500	19.4010.010.18	10	306
QS-20	95.0670.825.14	50	303	QS-503	93.0220.560.13	50	302
QS-21	95.0670.840.13	50	303	QS-504	93.0220.560.14	50	302
QS-22	95.0670.840.14	50	303	QS-505	19.4512.018.15	10	307
QS-23	95.0680.620.13	50	303	QS-507	19.4412.025.15	10	307
QS-24	95.0680.635.13	50	303	QS-509	93.0701.210.13	2	303
QS-25	95.0680.660.13	50	303	QS-512	20.0203.015.39	50	304
QS-26	95.0680.820.13	50	303	QS-513	93.0760.800.14	50	304
QS-27	95.0680.820.14	50	301, 303	QS-514	93.0760.800.13	50	304
QS-28	95.0680.820.15	50	301, 303	QS-515	93.0761.000.14	50	304
QS-29	95.0680.835.13	50	303	QS-516	93.0761.200.14	50	304
QS-30	95.0680.835.14	50	303	QS-517	93.0761.000.13	50	304
QS-31	95.0681.045.13	50	303	QS-518	93.0761.200.13	50	304
QS-32	19.4012.010.14	10	306	QS-519	19.4212.150.14	25	309
QS-33	19.4012.010.15	10	306	QS-519	19.4212.050.14	25	309
QS-34	19.4108.010.14	10	310	QS-520	19.4510.012.14	10	307
QS-35	19.4108.010.15	10	310	QS-521	19.4510.012.15	10	307
QS-36	19.4212.150.15	25	309	QS-522	93.0700.810.14	2	303
QS-36	19.4212.050.15	25	309	QS-523	93.0700.810.13	2	303
QS-38	93.0800.600.13	50	304	QS-525	93.0701.010.14	2	303
QS-39	93.0800.800.13	50	304	QS-526	93.0701.010.13	2	303
QS-40	93.0801.000.13	50	304	QS-528	19.4508.012.15	10	307
QS-41	95.0670.616.14	50	301	QS-529	19.4508.012.14	10	307
QS-42	95.0670.620.14	50	301	QS-530	95.0671.035.14	50	303
QS-43	95.0670.616.15	50	301	QS-531	95.0671.035.13	50	303
QS-44	95.0670.620.15	50	301	QS-532	95.0671.030.13	50	303
QS-45	95.0900.820.14	50	301	QS-533	95.0671.030.14	50	303
QS-46	93.0900.820.15	50	301	QS-534	95.0400.608.14	50	304
QS-47	95.0900.820.13	50	301	QS-535	95.0400.612.14	50	304
QS-48	95.0670.612.13	50	303	QS-536	95.0491.220.14	50	304
QS-49	93.0210.340.13	50	302	QS-537	95.0710.825.14	50	303
QS-50	93.0220.538.14	50	302	QS-538	95.0710.870.14	50	303
QS-51	93.0842.615.00	50	305	QS-539	95.0710.890.14	50	303
QS-53	95.0680.620.14	50	303	QS-540	95.0711.235.14	50	303
QS-54	95.0680.645.13	50	303	QS-541	93.0670.412.14	50	303
QS-55	93.0851.027.09	50	305	QS-542	93.0671.025.14	50	303
QS-56	93.0230.538.13	50	302	QS-543	95.0681.080.14	50	303
QS-57	93.0230.538.14	50	302	QS-544	95.0681.150.14	50	303
QS-58	19.4110.010.14	10	310	QS-547	93.0841.270.00	50	305
QS-59	19.4110.010.15	10	310	QS-548	19.4516.132.14	1	308
QS-60	19.4412.010.14	10	307	QS-549	19.4012.140.14	1	306
QS-61	19.4412.010.15	10	307	QS-551	95.0681.240.13	50	303
QS-62	19.4408.010.14	10	307	QS-552	95.0681.240.14	50	303
QS-63	19.4408.010.15	10	307	QS-555	93.0841.060.00	50	305
QS-64	19.4010.010.14	10	306	QS-556	93.0200.890.14	50	302
QS-65	19.4010.010.15	10	306	QS-557	19.4512.124.14	10	308
QS-66	93.0811.020.15	50	304	QS-558	19.4512.124.15	10	308
QS-67	95.0681.040.13	50	303	QS-559	19.4512.127.14	10	308
QS-68	95.0681.040.14	50	303	QS-560	19.4712.110.14	25	310
QS-69	93.0810.818.13	50	304	QS-561	19.4712.110.15	25	310
QS-70	95.0680.645.14	50	303	QS-562	19.4712.130.14	25	310
QS-71	95.0680.660.14	50	303	QS-563	19.4712.130.15	25	310
QS-72	95.0681.045.14	50	303				

NEW
NEW
NEW
NEW
NEW
NEW
NEW
NEW

Fixing materials for glass clamps



Hexagon socket countersunk head cap screw

MOD 0670 - DIN7991

For models 20, 21, 22, 25, 44, 46 in zinc

Zinc-plated					
INDOOR	QS	Q	D	L	
95.0670.616.15	QS-43	Q-4	M6	16	50

For models 24, 26 in zinc

Zinc-plated					
INDOOR	QS	Q	D	L	
95.0670.620.15	QS-44	Q-4	M6	20	50

For models 20, 21, 22, 25, 44, 46 in 304 and 316

316					
OUTDOOR	QS	Q	D	L	
95.0670.616.14	QS-41	Q-4	M6	16	50

For models 24, 26 in 304 and 316

316					
OUTDOOR	QS	Q	D	L	
95.0670.620.14	QS-42	Q-4	M6	20	50



Hexagon socket head cap screw

MOD 0680 - DIN912 / ISO 4762

For all models in zinc

Zinc-plated					
INDOOR	QS	Q	D	L	
95.0680.820.15	QS-28	Q-6	M8	20	50

For all models in 304 and 316

316					
OUTDOOR	QS	Q	D	L	
95.0680.820.14	QS-27	Q-6	M8	20	50



Adjustable screw

+/- 5°

MOD 0900

For all models in zinc

Zinc-plated					
INDOOR	QS	Q	D	L	
93.0900.820.15	QS-46	Q-5	M8	20	50

For all models in 304

304					
INDOOR	QS	Q	D	L	
95.0900.820.13	QS-47	Q-5	M8	20	50

For all models in 316

316					
OUTDOOR	QS	Q	D	L	
95.0900.820.14	QS-45	Q-5	M8	20	50



		INDOOR	OUTDOOR
.....18	1.4529		X
.....14	316		X
.....13	304	X	
.....15	zinc-plated	X	

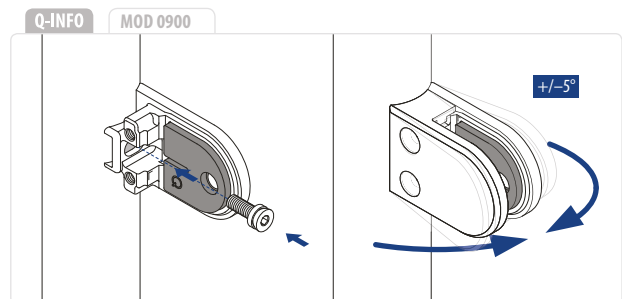
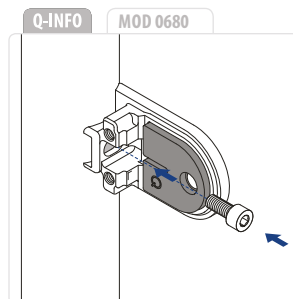
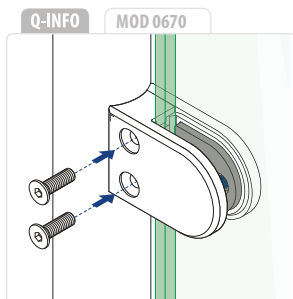

Fixing materials

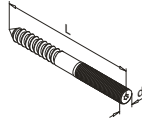

MOD 0100

304					
INDOOR	QS	Q	d	L	
95.0100.850.13	QS-1	Q-4	M8 x 12	50	50
95.0100.890.13	QS-85	Q-4	M8 x 33	90	50

316					
OUTDOOR	QS	Q	d	L	
93.0100.850.14	QS-2	Q-4	M8 x 12	50	50
93.0100.890.14	QS-86	Q-4	M8 x 33	90	50

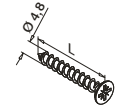

MOD 0220 - DIN7982 CH

304			
INDOOR	QS	L	
93.0220.525.13	QS-5	25	50
93.0220.538.13	QS-7	38	50
93.0220.560.13	QS-503	60	50

316			
OUTDOOR	QS	L	
93.0220.525.14	QS-6	25	50
93.0220.538.14	QS-50	38	50
93.0220.560.14	QS-504	60	50

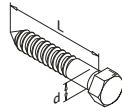

MOD 0200 - DIN571

304				
INDOOR	QS	d	L	
93.0200.760.13	QS-3	7	60	50

316				
OUTDOOR	QS	d	L	
93.0200.760.14	QS-4	7	60	50
93.0200.890.14	QS-556	8	90	50

NEW

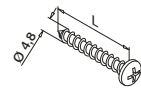

MOD 0230 - DIN7981 CH

304			
INDOOR	QS	L	
93.0230.525.13	QS-8	25	50
93.0230.538.13	QS-56	38	50

316			
OUTDOOR	QS	L	
93.0230.525.14	QS-9	25	50
93.0230.538.14	QS-57	38	50

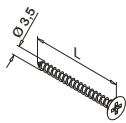

MOD 0210 - DIN7997

304			
INDOOR	QS	L	
93.0210.340.13	QS-49	40	50

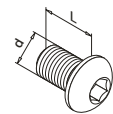

MOD 0511 - ISO7380

304					
INDOOR	QS	Q	d	L	
95.0511.516.13	QS-10	Q-3	M5	16	50
95.0511.616.13	QS-83	Q-4	M6	16	50

316					
OUTDOOR	QS	Q	d	L	
95.0511.516.14	QS-11	Q-3	M5	16	50
95.0511.616.14	QS-84	Q-4	M6	16	50



Fixing materials

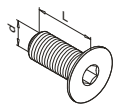

MOD 0670 - DIN7991

304					
INDOOR	QS	Q	d	L	
95.0670.520.13	QS-12	Q-3	M5	20	50
95.0670.612.13	QS-48	Q-4	M6	12	50
95.0670.620.13	QS-14	Q-4	M6	20	50
95.0670.625.13	QS-15	Q-4	M6	25	50
95.0670.630.13	QS-17	Q-4	M6	30	50
95.0670.825.13	QS-19	Q-5	M8	25	50
95.0670.840.13	QS-21	Q-5	M8	40	50
316					
OUTDOOR	QS	Q	d	L	
93.0670.412.14	QS-541	Q-2,5	M4	12	50
95.0670.520.14	QS-13	Q-3	M5	20	50
95.0670.612.14	QS-89	Q-4	M6	12	50
95.0670.625.14	QS-16	Q-4	M6	25	50
95.0670.630.14	QS-18	Q-4	M6	30	50
95.0670.825.14	QS-20	Q-5	M8	25	50
95.0670.840.14	QS-22	Q-5	M8	40	50

MOD 0671 - DIN7991

304					
INDOOR	QS	Q	d	L	
95.0671.030.13	QS-532	Q-6	M10	30	50
95.0671.035.13	QS-531	Q-6	M10	35	50
316					
OUTDOOR	QS	Q	d	L	
93.0671.025.14	QS-542	Q-6	M10	25	50
95.0671.030.14	QS-533	Q-6	M10	30	50
95.0671.035.14	QS-530	Q-6	M10	35	50
95.0671.240.14	QS-74	Q-8	M12	40	50

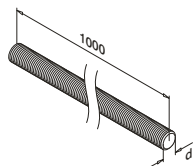

MOD 0700 - DIN976

304				
INDOOR	QS	d		
93.0700.810.13	QS-523	M8	2	
316				
OUTDOOR	QS	d		
93.0700.810.14	QS-522	M8	2	

MOD 0701 - DIN976

304			
INDOOR	QS	d	
93.0701.010.13	QS-526	M10	2
93.0701.210.13	QS-509	M12	2
316			
OUTDOOR	QS	d	
93.0701.010.14	QS-525	M10	2

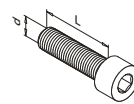

MOD 0680 - DIN912 / ISO4762

Zinc-plated					
INDOOR	QS	Q	d	L	
95.0680.820.15	QS-28	Q-6	M8	20	50
304					
INDOOR	QS	Q	d	L	
95.0680.620.13	QS-23	Q-5	M6	20	50
95.0680.635.13	QS-24	Q-5	M6	35	50
95.0680.645.13	QS-54	Q-5	M6	45	50
95.0680.660.13	QS-25	Q-5	M6	60	50
95.0680.820.13	QS-26	Q-6	M8	20	50
95.0680.835.13	QS-29	Q-6	M8	35	50
316					
OUTDOOR	QS	Q	d	L	
95.0680.620.14	QS-53	Q-5	M6	20	50
95.0680.645.14	QS-70	Q-5	M6	45	50
95.0680.660.14	QS-71	Q-5	M6	60	50
95.0680.820.14	QS-27	Q-6	M8	20	50
95.0680.835.14	QS-30	Q-6	M8	35	50

MOD 0681 - DIN912 / ISO4762

304					
INDOOR	QS	Q	d	L	
95.0681.040.13	QS-67	Q-8	M10	40	50
95.0681.045.13	QS-31	Q-8	M10	45	50
95.0681.240.13	QS-551	-	M12	40	50
316					
OUTDOOR	QS	Q	d	L	
95.0681.040.14	QS-68	Q-8	M10	40	50
95.0681.045.14	QS-72	Q-8	M10	45	50
95.0681.080.14	QS-543	Q-8	M10	80	50
95.0681.150.14	QS-544	Q-8	M10	150	50
95.0681.240.14	QS-552	-	M12	40	50

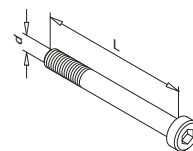

MOD 0710 - DIN6912

316					
OUTDOOR	QS	Q	d	L	
95.0710.825.14	QS-537	Q-6	M8	25	50
95.0710.870.14	QS-538	Q-6	M8	70	50
95.0710.890.14	QS-539	Q-6	M8	90	50

MOD 0711 - DIN6912

316					
OUTDOOR	QS	Q	d	L	
95.0711.235.14	QS-540	Q-8	M12	35	50



Fixing materials

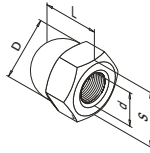

MOD 0760 - DIN1587

304						
INDOOR	QS	S	d	D	L	
93.0760.800.13	QS-514	13	M8	12,5	15	50
316						
OUTDOOR	QS	S	d	D	L	
93.0760.800.14	QS-513	13	M8	12,5	15	50

MOD 0761 - DIN1587

304						
INDOOR	QS	S	d	D	L	
93.0761.000.13	QS-517	17	M10	16	18	50
93.0761.200.13	QS-518	19	M12	18	22	50
316						
OUTDOOR	QS	S	d	D	L	
93.0761.000.14	QS-515	17	M10	16	18	50
93.0761.200.14	QS-516	19	M12	18	22	50

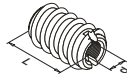

MOD 0810 - DIN7965

304					
INDOOR	QS	d		L	
93.0810.818.13	QS-69	M8	Ø14,5	18	50

MOD 0811 - DIN7965

Zinc-plated					
INDOOR	QS	d		L	
93.0811.020.15	QS-66	M10	Ø17	20	50

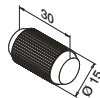

MOD 0203

Wood		
INDOOR	QS	
20.0203.015.39	QS-512	50

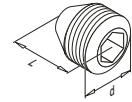

MOD 0400 - DIN916 / ISO4029

304					
INDOOR	QS	Q	d	L	
95.0400.505.13	QS-91	Q-2,5	M5	5	50
316					
OUTDOOR	QS	Q	d	L	
95.0400.505.14	QS-90	Q-2,5	M5	5	50
95.0400.608.14	QS-534	Q-3	M6	8	50
95.0400.610.14	QS-92	Q-3	M6	10	50
95.0400.612.14	QS-535	Q-3	M6	12	50

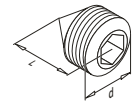

MOD 0490 - DIN914 / ISO4027

304					
INDOOR	QS	Q	d	L	
95.0490.506.13	QS-94	Q-2,5	M5	6	50
316					
OUTDOOR	QS	Q	d	L	
95.0490.506.14	QS-93	Q-2,5	M5	6	50
95.0491.220.14	QS-536	Q-6	M12	20	50

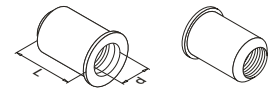

MOD 0800

304						
INDOOR	QS	Q	d		L	
93.0800.600.13	QS-38	Q-29	M6	Ø9,0	16	50
93.0800.800.13	QS-39	Q-29	M8	Ø11,0	17	50
316						
OUTDOOR	QS	Q	d		L	
93.0800.600.14	QS-80	Q-29	M6	Ø9,0	16	50
93.0800.800.14	QS-81	Q-29	M8	Ø11,0	17	50

MOD 0801

304						
INDOOR	QS	Q	d		L	
93.0801.000.13	QS-40	Q-29	M10	Ø12,0	21	50
316						
OUTDOOR	QS	Q	d		L	
93.0801.000.14	QS-82	Q-29	M10	Ø12,0	21	50

Q-INFO

MOD 0800 / 0801

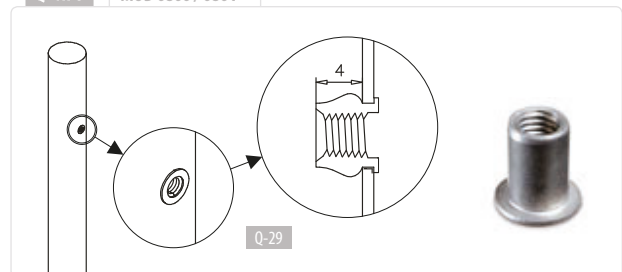

Q-INFO

MOD 0811 / 0118

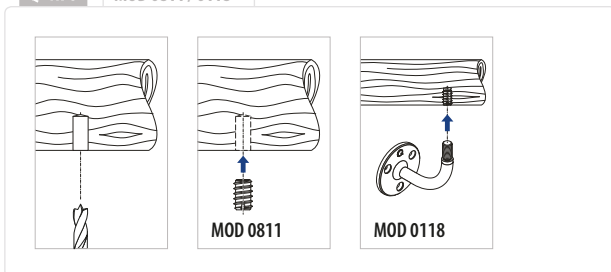

Fixing materials

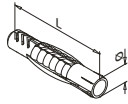

MOD 0840

Accessories				
	QS	Ø	L	
93.0840.635.00	QS-87	6	35	100

MOD 0841

Accessories				
	QS	Ø	L	
93.0841.060.00	QS-555	10	60	50

NEW

Accessories				
	QS	Ø	L	
93.0841.270.00	QS-547	12	70	25

MOD 0851

Brass		
IN/OUTDOOR	QS	
93.0851.027.09	QS-55	50

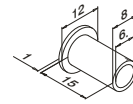
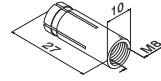

Grommet
for cable

MOD 0842

Accessories		
IN/OUTDOOR	QS	
93.0842.615.00	QS-51	50



Mounting-plates
for Easy Glass®,
1, 2, 3, 4, 5 mm
520 pieces

MOD 6921

Accessories			
	Q		
19.6921.000.00	Q-62		1

MOD 0712

Accessories			
	Q	L	
19.0712.300.00	Q-50	300 mm	100

Q-INFO MOD 0840 / 0841

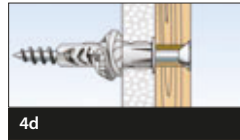
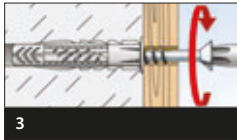
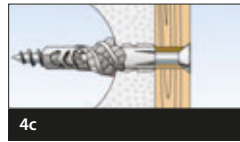
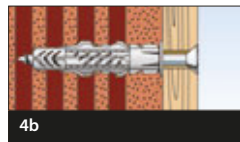

fischer

Q-INFO MOD 0851

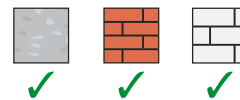
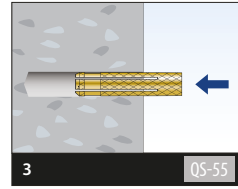
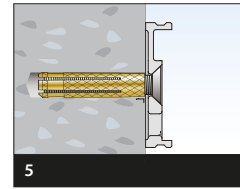
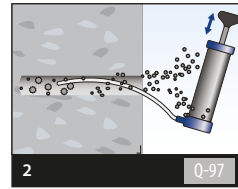
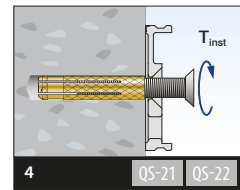
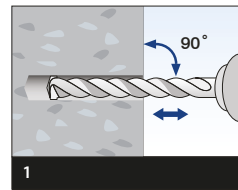

Q-INFO MOD 6921

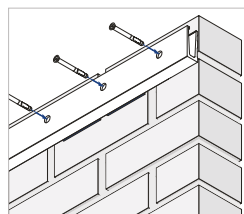
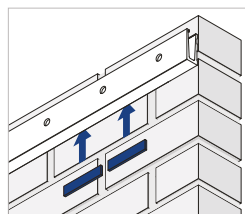

Q-INFO MOD 0842

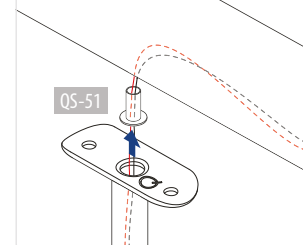

Fixing materials for railing systems

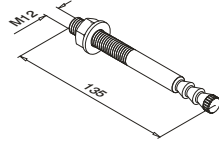

MOD 4012

316						
OUTDOOR	QS	Q-railing				
19.4012.140.14	QS-549	QVMZ-A75 M12-40/135 A4	Ø12	10		



Q-INFO

Manual Q-anchor VMZ

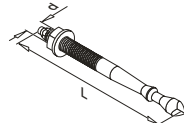
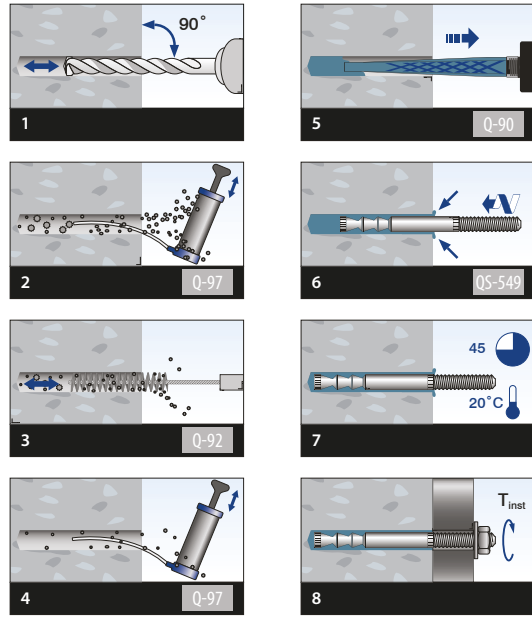

MOD 4010

Zinc-plated						
INDOOR	QS	fischer	d		L	
19.4010.010.15	QS-65	FHB II-A S M10x60/10	M10 Ø10	95	10	

316						
OUTDOOR	QS	fischer	d		L	
19.4010.010.14	QS-64	FHB II-A S M10x60/10 A4	M10 Ø10	95	10	

2205		1.4529				
OUTDOOR	QS	fischer	d		L	
19.4010.010.18	QS-500	FHB II-A S M10x60/10 C	M10 Ø10	95	10	

MOD 4012

Zinc-plated						
INDOOR	QS	fischer	d		L	
19.4012.010.15	QS-33	FHB II-A S M12x75/10	M12 Ø12	117	10	

316						
OUTDOOR	QS	fischer	d		L	
19.4012.010.14	QS-32	FHB II-A S M12x75/10 A4	M12 Ø12	117	10	
19.4012.040.14	QS-88	FHB II-A S M12x75/40 A4	M12 Ø12	146	10	



Q-INFO

Manual fischer Highbond anchor FHB II-A S

FHB

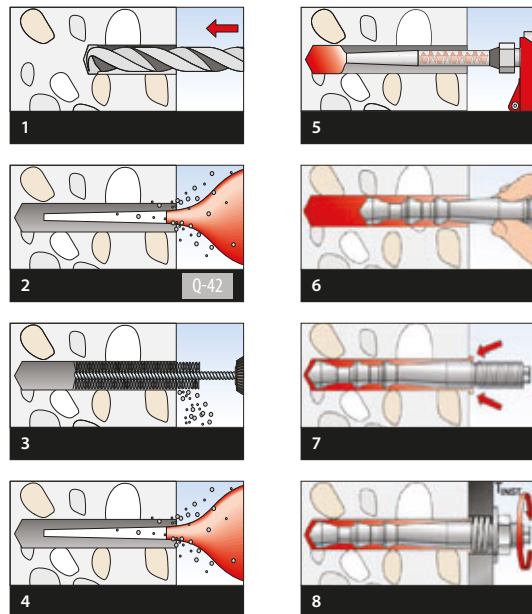

fischer



Fixing materials for railing systems



MOD 4408

Zinc-plated							
INDOOR	QS	fischer	d	L			
19.4408.010.15	QS-63	FHB II-A L M8x60/10	M8	Ø10	93	10	
316							
OUTDOOR	QS	fischer	d	L			
19.4408.010.14	QS-62	FHB II-A L M8x60/10 A4	M8	Ø10	93	10	

MOD 4410

Zinc-plated							
INDOOR	QS	fischer	d	L			
19.4410.010.14	QS-75	FHB II-A L M10x95/10 A4	M10	Ø12	95	10	

MOD 4412

Zinc-plated							
INDOOR	QS	fischer	d	L			
19.4412.010.15	QS-61	FHB II-A L M12x120/10	M12	Ø14	162	10	
19.4412.025.15	QS-507	FHB II-A L M12x120/25	M12	Ø14	175	10	
316							
OUTDOOR	QS	fischer	d	L			
19.4412.010.14	QS-60	FHB II-A L M12x120/10 A4	M12	Ø14	162	10	



MOD 4508

Zinc-plated							
INDOOR	QS	fischer	d	L			
19.4508.012.15	QS-528	RG 12x90 M8 I	M8	Ø14	90	10	
316							
OUTDOOR	QS	fischer	d	L			
19.4508.012.14	QS-529	RG 12x90 M8 I A4	M8	Ø14	90	10	

MOD 4510

Zinc-plated							
INDOOR	QS	fischer	d	L			
19.4510.012.15	QS-521	RG 16x90 M10 I	M10	Ø18	90	10	
316							
OUTDOOR	QS	fischer	d	L			
19.4510.012.14	QS-520	RG 16x90 M10 I A4	M10	Ø18	90	10	

MOD 4512

Zinc-plated							
INDOOR	QS	fischer	d	L			
19.4512.018.15	QS-505	RG 18x125 M12 I	M12	Ø20	125	10	
316							
OUTDOOR	QS	fischer	d	L			
19.4512.018.14	QS-73	RG 18x125 M12 I A4	M12	Ø20	125	10	

Q-INFO

Manual fischer Highbond anchor FHB II-A L

FHB

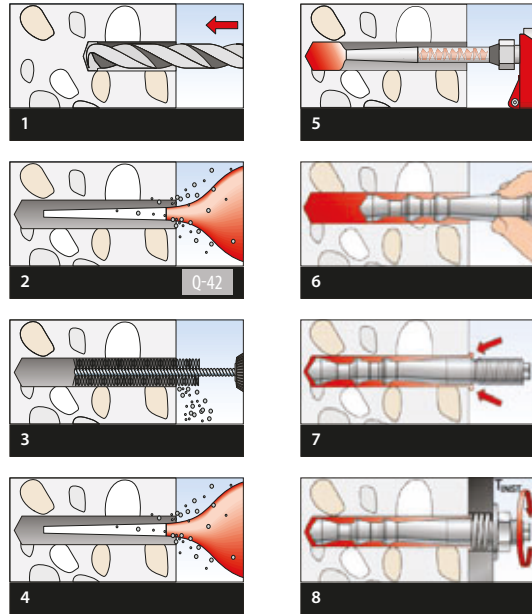

fischer



Q-INFO

Manual fischer anchor RG MI

FHB

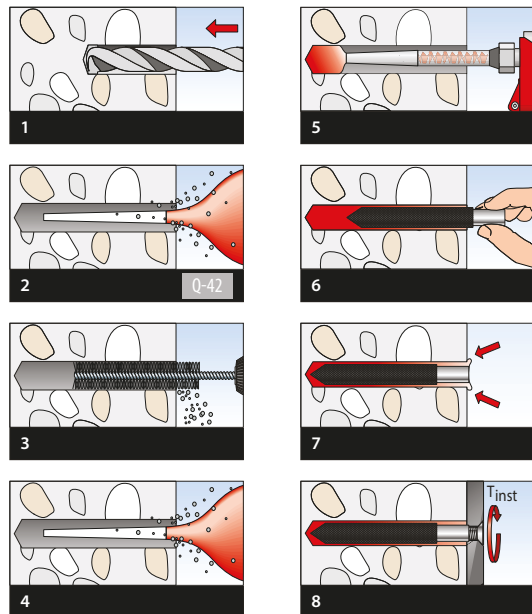

fischer



Fixing materials for railing systems

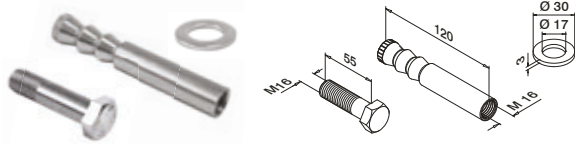

MOD 4516

316	V4A			
OUTDOOR	QS	Q-railing		
19.4516.132.14	QS-548	Q VMZ-IG 115 M16 A4	Ø22	10

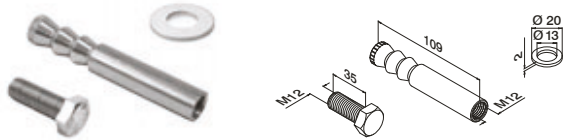

MOD 4512

316	V4A			
OUTDOOR	QS	Q-railing		
19.4512.127.14	QS-559	Q VMZ-IG 105 M12 A4	Ø18	10

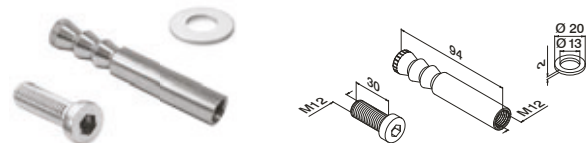

MOD 4512

Zinc-plated				
INDOOR	QS	Q-railing		
19.4512.124.15	QS-558	Q VMZ-IG 90 M12	Ø18	10
316	V4A			
OUTDOOR	QS	Q-railing		
19.4512.124.14	QS-557	Q VMZ-IG 90 M12 A4	Ø18	10



Q-INFO

Manual Q-anchor VMZ-IG

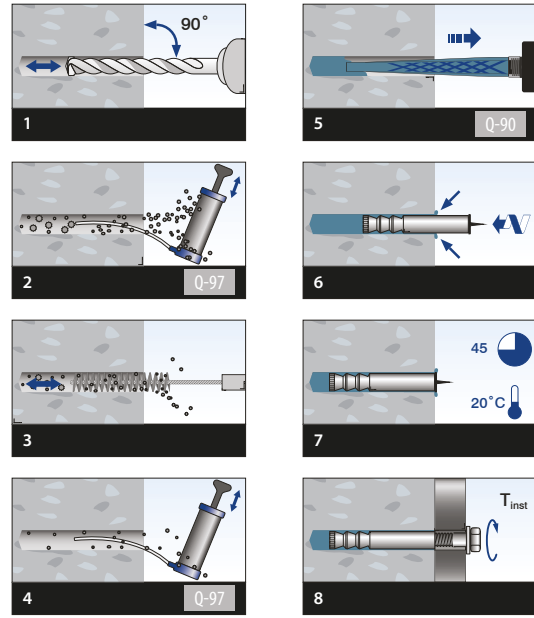

Q-INFO

Manual Q-anchor VMZ-IG

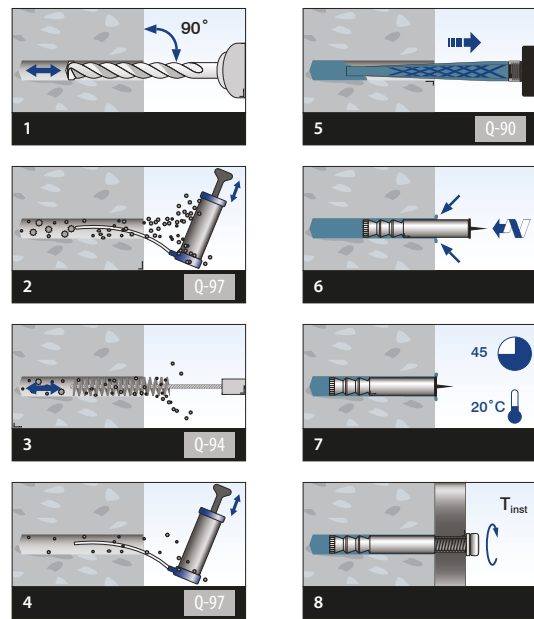

Fixing materials for railing systems



MOD 4212

Zinc-plated						
INDOOR	QS	Q-railing	Ø		L	
19.4212.150.15	QS-36	Q SZ 12/50	12	Ø12,0	120	25
316						
OUTDOOR	QS	Q-railing	Ø		L	
19.4212.150.14	QS-519	Q SZ 12/50 A4	12	Ø12,0	120	25



Q-INFO MOD 4212.150

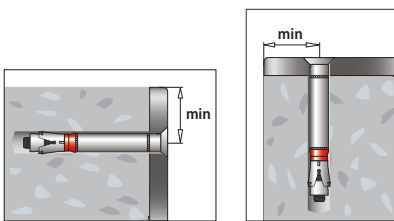

	MOD 6903	MOD 6904
19.4212.150.15	min. 60	min. 73,5
19.4212.150.14	min. 70	min. 88,5

Please note for specifications such as mounting and glass dimension measurements, see the respective certificates.



MOD 4212

Zinc-plated						
INDOOR	QS	fischer	Ø		L	
19.4212.050.15	QS-36	FH II 12/50 SK	Ø12	Ø12,0	125	25
316						
OUTDOOR	QS	fischer	Ø		L	
19.4212.050.14	QS-519	FH II 12/50 SK A4	Ø12	Ø12,0	125	25



Q-INFO MOD 4212.050

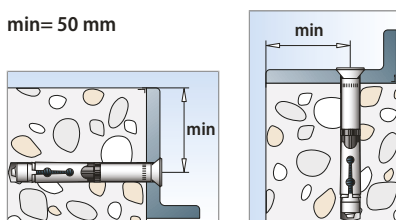

Q-INFO

Manual Q-anchor SZ 12/50

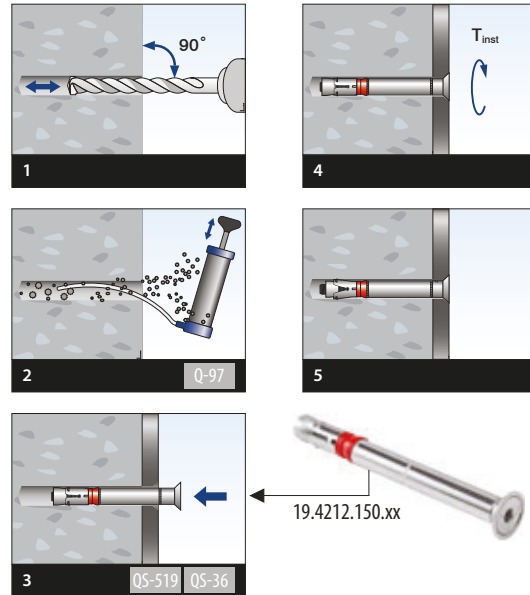

Q-INFO

Manual fischer anchor 12/50SK

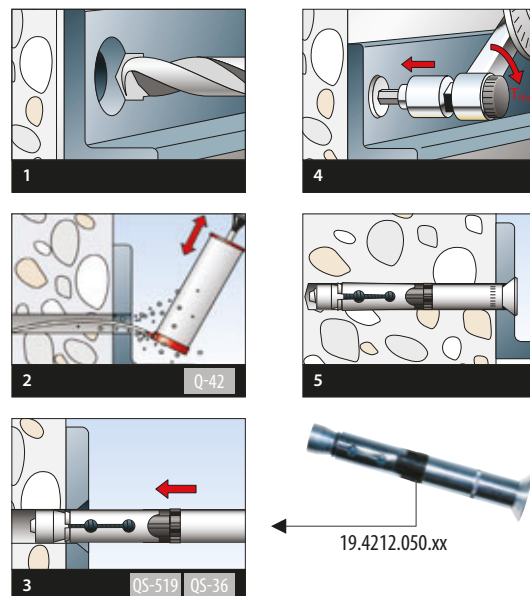

Fixing materials for railing systems



MOD 4108

Zinc-plated							
INDOOR	QS	fischer	d		L		
19.4108.010.15	QS-35	FAZ II 8/10	M8	Ø8	75	10	
316							
OUTDOOR	QS	fischer	d		L		
19.4108.010.14	QS-34	FAZ II 8/10 A4	M8	Ø8	75	10	

MOD 4110

Zinc-plated							
INDOOR	QS	fischer	d		L		
19.4110.010.15	QS-59	FAZ II 10/10	M10	Ø10	95	10	
316							
OUTDOOR	QS	fischer	d		L		
19.4110.010.14	QS-58	FAZ II 10/10 A4	M10	Ø10	95	10	



Q-INFO

Manual fischer anchor FAZ II

FAZ

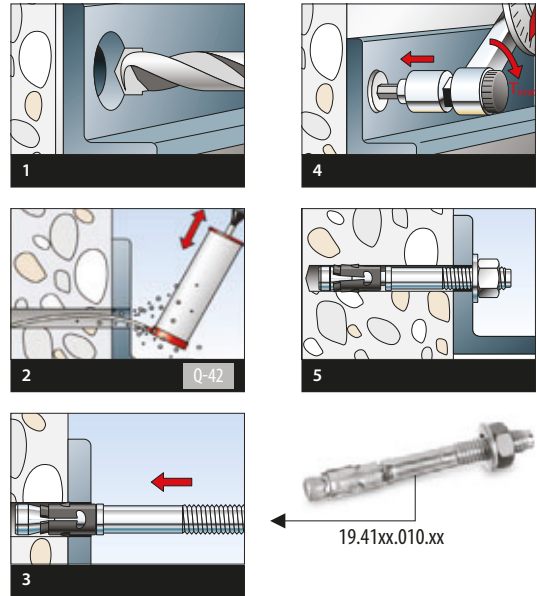

fischer



MOD 4712

Zinc-plated							
INDOOR	QS	Q-railing	Ø		L		
19.4712.110.15	QS-561	Q SZ 12/10	12	Ø12,0	85	25	
19.4712.130.15	QS-563	Q SZ 12/30	12	Ø12,0	105	25	
316							
OUTDOOR	QS	Q-railing	Ø		L		
19.4712.110.14	QS-560	Q SZ 12/10 A4	12	Ø12,0	85	25	
19.4712.130.14	QS-562	Q SZ 12/30 A4	12	Ø12,0	105	25	

NEW



Q-INFO

Manual Q-anchor SZ 12/10 + SZ 12/30

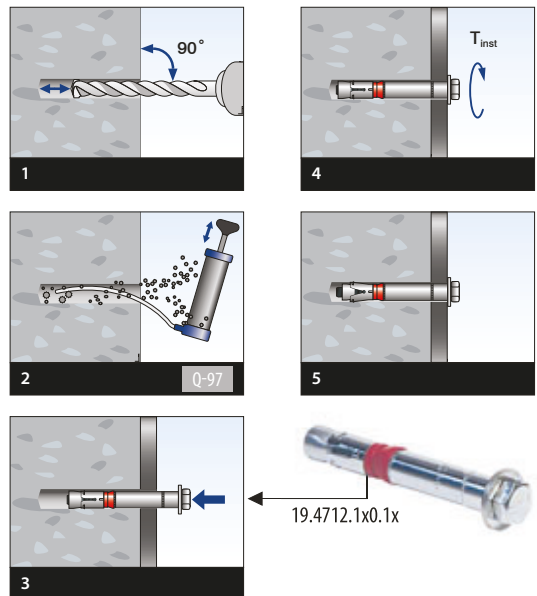

Accessories for railing systems



Injection mortar

MOD 4095

Accessories			
	Q	e	
19.4095.101.00	Q-90	150 ml	1



Mastic gun

For injection mortar FIS EM 390 S

MOD 4097

Accessories		
	Q	
19.4097.000.00	Q-68	1



Injection mortar

FIS EM 390 S

MOD 4097

Accessories			
	Q	e	
19.4097.001.00	Q-66	390 ml	1



Mixer

For injection mortar FIS EM 390 S

MOD 4097

Accessories		
	Q	
19.4097.002.00	Q-69	10



Injection mortar

FIS HB 150 C

MOD 4095

Accessories			
	Q	e	
19.4095.001.00	Q-40	145 ml	1



Mixer

For injection mortar FIS HB 150 C

MOD 4095

Accessories		
	Q	
19.4095.002.00	Q-41	10



Air pump

For cleaning drill holes

MOD 4095

Accessories		
	Q	
19.4095.103.00	Q-97	1



Air pump

For cleaning drill holes

MOD 4095

Accessories		
	Q	
19.4095.003.00	Q-42	1



Cleaning brush for cleaning drill holes

MOD 4095

Accessories			
	Q		
19.4095.104.00	Q-91	Ø10	1
19.4095.105.00	Q-92	Ø12	1
19.4095.106.00	Q-93	Ø14	1
19.4095.108.00	Q-94	Ø18	1
19.4095.109.00	Q-95	Ø20	1
19.4095.110.00	Q-96	Ø22	1



Cleaning brush for cleaning drill holes

MOD 4095

Accessories			
	Q		
19.4095.004.00	Q-43	Ø12	1
19.4095.005.00	Q-67	Ø18	1

Consumable articles



Q-glue®

Stainless steel - High strength fixative
Consumption per bonding ca. 1 ml

MOD 1331

Accessories			
	Q	e	
19.1331.000.00	Q-21	50 ml	1

Glueing connections per bottle (50 ml)

Ø 16 mm	Ø 42,4 mm	Ø 48,3 mm	Ø 60,3 mm
150	60	50	40



Wood glue

PVAC glue for wooden bonding applications

MOD 1335

Accessories			
	Q	e	
19.1335.000.00	Q-73	250 ml	1



Q-seal

Glass silicone, colour black
with spray nozzle included

MOD 1340

Accessories			
	Q	e	
19.1340.310.00	Q-24	310 ml = ca. 11,40 m	1



Double-sided adhesive tape

MOD 1350

Accessories				
	Q	W	L (m)	
19.1350.018.00	Q-52	19	66	1

Q-INFO MOD 1350

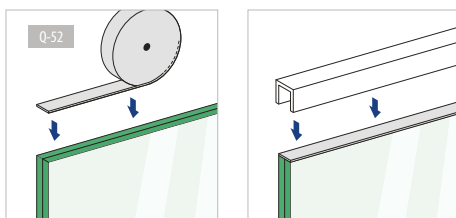

Care and maintenance



Q-cleaner

Stainless steel protecting spray,
concentrated, without propellant
300 ml

MOD 0601

Accessories			
	Q	e	
19.0601.000.00	Q-23	300 ml	1



Q-ultra-clean

Chemical stainless steel cleaner to
remove heavy dirt and rust stains.
Q-ultra-clean rebuilds/strengthens the
passive layer of the stainless steel.
500 ml

MOD 0610

Accessories			
	Q	e	
19.0610.000.00	Q-22	500 ml	1



Scotch®-Brite

Abrasive pads to remove scratches on
stainless steel products

MOD 0640

Accessories			
	Q		
19.0640.000.00	Q-25		10



Q-glass tex

Glass cloths, 100% viscose, 33x37cm

MOD 0660

Accessories			
	Q		
19.0660.000.00	Q-27		20

Q-INFO

MOD 0640 / 0610



Q-25



Q-22

Q-ultra-clean
500 ml
19.0610.000.00

Drilling and tapping



Drilling template

MOD 0718

Accessories				
	Q	Ø	M	
19.0718.442.00	Q-74	Ø 42,4	M5, M6, M8, M10	1
19.0718.448.00	Q-75	Ø 48,3	M5, M6, M8, M10	1



Cutting and drilling oil

Concentrated, without propellant
300 ml

MOD 0714

Accessories			
	Q	e	
19.0714.001.00	Q-64	300 ml	1



Flow-drill set

- Standard set includes:
- Toolholder MC2
 - Collet ER25
 - Jaw spanner
 - C-spanner
 - Flowdrill of your choice
 - Lubricant paste for use with the flowdrills
 - Lubricant oil for use with the flowtabs
 - Brass brush (for lubricant paste)
 - Bristle brush (for lubricant oil)
 - Flowtap

MOD 0717

Accessories			
	Q	M	
19.0717.005.00	Q-58	M5	1
19.0717.006.00	Q-59	M6	1
19.0717.008.00	Q-60	M8	1

Complete set



Drilling template

(2x), on guide rail

MOD 0719

Accessories				
	Q	Ø	M	
19.0719.042.00	Q-76	Ø 42,4	M5, M6, M8, M10	1
19.0719.048.00	Q-77	Ø 48,3	M5, M6, M8, M10	1



Drillbit with stopper

for wood

MOD 0708

Accessories			
	Q	Ø	
19.0708.015.00	Q-80	15	1



14-parts drilling and tapping set

for stainless steel

MOD 0714

Accessories			
	Q	Ø	
19.0714.000.00	Q-61	M3 - M12	1

Q-INFO MOD 0719



Q-INFO MOD 0717

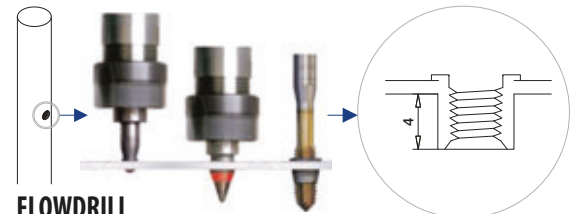

FLOWDRILL

Tools



Hexagon screw driver set

7 pieces

MOD 0701

Accessories								
Q (☐)								
19.0701.000.00	Q-2	Q-2,5	Q-3	Q-4	Q-5	Q-6	Q-8	1



Gripper for blind-rivet-nut

MOD 0703

Accessories			
Q	Ø		
19.0703.000.00	Q-29	M6, M8, M10	1



Plastic hammer

MOD 0704

Accessories		
Q		
19.0704.000.00	Q-45	1



Stainless steel tool box, 25-piece, 6 screwdrivers, 9 bits, 9 offset screwdrivers

MOD 0720

Accessories											
Q	Q (☐)										
19.0720.000.14	Q-70	Q-1,5	Q-2	Q-2,5	Q-3	Q-4	Q-5	Q-6	Q-8	Q-10	1



C-spanner

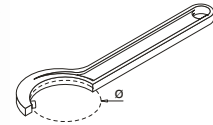

MOD 0702

Accessories			
	Q	Ø	
19.0702.025.00	Q-30	25 - 28	1
19.0702.030.00	Q-31	30 - 32	1
19.0702.050.00	Q-32	45 - 50	1
19.0702.060.00	Q-33	58 - 62	1
19.0702.070.00	Q-51	68 - 75	1



Face pin wrench

for Ø3 mm holes, pin 2,9 mm, distance 15 mm

MOD 0705

Accessories		
Q		
19.0705.315.00	Q-78	1



Cable cutter

MOD 7800

Accessories			
	Q	Ø	
14.7800.000.00	Q-39	3,2	1

Q - Lights

Circlip pliers



For Ø 2 mm holes, pin 4,0 mm, distance 28 mm

MOD 0706

Accessories		
Q		
19.0706.002.00	Q-10	1



Fast Fix release tool

MOD 7802

316		
OUTDOOR		
14.7802.003.00		1

Q-INFO

MOD 0720

Incorrect handling of stainless steel can lead to the formation of extraneous rust. This often results in visible damage, functional limitations and further corrosion leading to extra costs, customer complaints and even major safety risks. By using special stainless steel tools, the development of extraneous rust can be prevented. These stainless steel tools have been hardened to the same level as conventional tools.

Tools



Easy Glass® multitool

MOD 6920

Accessories			
	Q		
19.6920.000.00	Q-71		1



Q-glass suction lifter

2 cups, carrying capacity / lifting direction:
60 kg / parallel

MOD 0750

Accessories		
	Q	
19.0750.000.00	Q-28	

International Design Model Protection



Plate/glass lifting tool

MOD 0751

Accessories			
	Q		
19.0751.000.00	Q-55		2



Glass fitting aid

MOD 0715

Accessories		
	Q	
19.0715.000.00	Q-56	



Mounting tool

MOD 0710

Accessories		
	Q	
19.0710.640.35	Q-81	



Mounting tool

MOD 0709

Accessories			
	Q	Ø	
19.0709.000.35	Q-82	42,0 + 48,0	



Mounting tool

MOD 0710

Accessories			
	Q	Ø	
19.0710.042.12	Q-20	Ø 42	
19.0710.048.12	Q-79	Ø 48	

Q-INFO

MOD 6920



Q-INFO

MOD 0751



Q-INFO

MOD 0715

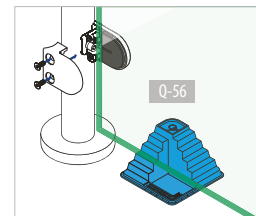
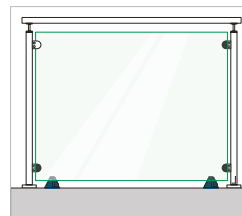

Tools



Spirit level

For tube, round and square.

Now even more precise.

MOD 0901

Accessories		
	Q	
19.0901.000.00	Q-46	1



Spirit level

□ 40, Ø 42,4, Ø 48,3 mm

MOD 0500

Accessories		
	Q	
19.0500.000.00	Q-72	1

Stainless steel should be cut with an appropriate saw for efficient work and ideal results. To guarantee this, stainless steel saws have an ultra-strong but slowly rotating motor and incorporate a cooling mechanism to protect the saw and material. The saw's minimal weight makes it the professional 'must have' tool on site.

Stainless steel saw



Motor 0,8kW - 230V, 54 rpm, automatic cooler, 38 kg, sizes 300x800x750 (B x L x H), saw blade not included

0°	85	75	100 x 65	100
45°	80	75	90 x 60	100

19.0900.000.00

Base frame for stainless steel saw, 13 kg



19.0900.001.00

Saw blade for stainless steel saw

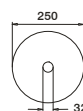

HSS-DM 05, 250 x 2,0 x 32, 200 Z / ZT 4

19.0900.002.00

Electrical adapter plug



19.0900.005.00

AUS/NZ/CN(part)/CH/FLI/GR/RCH(part)/GB/IRL/Afrika/Asia/Commonwealth/USA/DN/J/GU



MOD 0900

Accessories		
	Q	
19.0900.000.00	Q-34	1
19.0900.001.00	Q-35	1
19.0900.002.00	Q-36	1
19.0900.005.00	Q-37	1

Q-INFO

MOD 0901



Q-INFO

MOD 0500

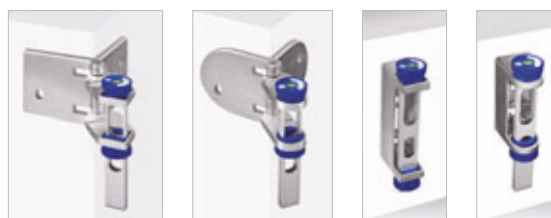

Displays

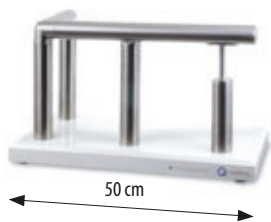

MOD 0004

Display

15.0004.000.00 Railing systems - Stainless steel

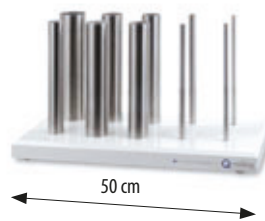

MOD 0007

Display

15.0007.000.00 Tubes and bars - Stainless steel

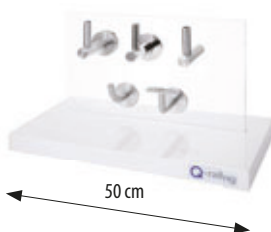

MOD 0006

Display

15.0006.000.00 Handrail brackets - Stainless steel



MOD 0024

Display

15.0024.000.00 Naturail

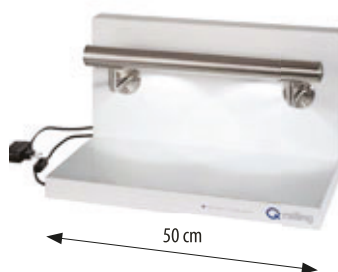

MOD 0337

Display

15.0337.000.00 LED-spotlights

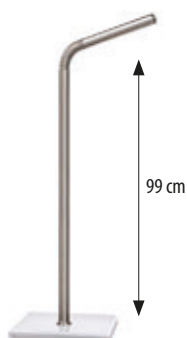

MOD 0015

Display

15.0015.000.00 Flex Connect®

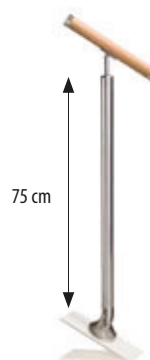

MOD 0029

Display

15.0029.000.00 Adjustable flange

Displays



MOD 0303

Display

15.0303.000.00 Q-glass



MOD 0335

Display

15.0335.000.00 Glass clamps

Promotion



MOD 0037

Promobox

15.0037.000.00 Ultra Range



Promobox Easy Glass®

9000.0000.003.42 Promobox Easy Glass® 3kN

9000.0000.003.49 Promobox Easy Glass® Slim, fascia mount

9000.0000.004.75 Promobox Easy Glass® Slim, top mount



MOD 0050

Promoset

15.0050.000.00 Fast Fix



MOD 0012

Promo portfolio

15.0012.000.00 Easy Q-Web®

Promotion



Q-video

9000.0000.000.39 Assembly guide (D, GB)



Q-video

9000.0000.003.27 Q-railing corporate video, (D, GB, DK, NL)



Easy Glass® brochure

Order your version of the current brochure.



Q-inspirations brochure

Order your version of the current brochure.



Q-designs 1 brochure

Order your version of the current brochure.



Q-designs 2 brochure

Order your version of the current brochure.



Q-designs 3 brochure

Order your version of the current brochure.

NEW



SERVICE

5



Q-RAILING LIKES TO MAKE IT EASY FOR YOU!

This is why we offer various options for customized prefixing and bending.

Prefix

Don't have sufficient time or the necessary equipment for a certain project? Then have us do the preparatory work for you! With services like prefix ready-made products, drilling, cutting and milling, we can provide you with ready-made products made according to your exact specifications. You'll be able to get started with the final installation as soon as the products reach you.

Bending

Save time and money, and eliminate risk by ordering meticulously 2D and 3D bended tubes. Just let us know what sizes and deflection degrees you need and we will provide you with a customised solution.

Download your order form for prefix, cutting and bending www.q-railing.com



INDEX

SERVICE



324 - 336

Prefix
(prefabricated products)



337, 338, 365

Drilling, milling



338 - 351

Cutting

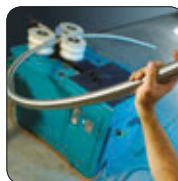

353 - 369

2D and 3D bending



PREFIX

Q-line

Service

Enquiry form

MOD 0542 (H=970 mm)

- Ø 42,4 x 2,6 mm - 304
- Ø 42,4 x 2,6 mm - 316

MOD 0542



129

Specification

Type

Quantity

<input type="checkbox"/> With glass clamps 260 - 284 H1: _____ mm H2: _____ mm		Glass clamp <input type="checkbox"/> MOD 20 <input type="checkbox"/> MOD 21 <input type="checkbox"/> MOD 22 <input type="checkbox"/> MOD 24 <input type="checkbox"/> MOD 25 <input type="checkbox"/> MOD 26 <input type="checkbox"/> MOD 27 <input type="checkbox"/> MOD 28 <input type="checkbox"/> MOD 44 <input type="checkbox"/> MOD 46 <input type="checkbox"/> MOD 51 <input type="checkbox"/> MOD 52	Glass thickness <input type="checkbox"/> 6 mm <input type="checkbox"/> 6,76 mm <input type="checkbox"/> 8 mm <input type="checkbox"/> 8,38 mm <input type="checkbox"/> 8,76 mm <input type="checkbox"/> 9,52 mm <input type="checkbox"/> 10 mm <input type="checkbox"/> 10,76 mm <input type="checkbox"/> 11,52 mm <input type="checkbox"/> 12 mm <input type="checkbox"/> 12,76 mm		
<input type="checkbox"/> With glass clamps 260 - 284 H1: _____ mm H2: _____ mm H3: _____ mm H4: _____ mm		Glass clamp <input type="checkbox"/> MOD 20 <input type="checkbox"/> MOD 21 <input type="checkbox"/> MOD 22 <input type="checkbox"/> MOD 24 <input type="checkbox"/> MOD 25 <input type="checkbox"/> MOD 26 <input type="checkbox"/> MOD 27 <input type="checkbox"/> MOD 28 <input type="checkbox"/> MOD 44 <input type="checkbox"/> MOD 46 <input type="checkbox"/> MOD 51 <input type="checkbox"/> MOD 52	Glass thickness <input type="checkbox"/> 6 mm <input type="checkbox"/> 6,76 mm <input type="checkbox"/> 8 mm <input type="checkbox"/> 8,38 mm <input type="checkbox"/> 8,76 mm <input type="checkbox"/> 9,52 mm <input type="checkbox"/> 10 mm <input type="checkbox"/> 10,76 mm <input type="checkbox"/> 11,52 mm <input type="checkbox"/> 12 mm <input type="checkbox"/> 12,76 mm		
<input type="checkbox"/> With Spider 291 H1: _____ mm H2: _____ mm		Spider <input type="checkbox"/> MOD 0750 <input type="checkbox"/> MOD 0751 <input type="checkbox"/> MOD 0752 <input type="checkbox"/> MOD 0753	Glass thickness <input type="checkbox"/> 8 - 13,52 mm		

Sender

Name _____

Telephone _____

Company _____

Telefax _____

Street, house no. _____

E-mail _____

Postcode, city, country _____

Customer number _____



PREFIX

Q-line

Service

Enquiry form

129

MOD 0542

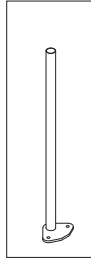

MOD 0542 (H=970 mm)

Ø 42,4 x 2,6 mm - 304

Ø 42,4 x 2,6 mm - 316

Specification

Type

Quantity

<input type="checkbox"/> With crossbar holders 155 - 159 H1: _____ mm H2: _____ mm		Crossbar holders per post _____ pieces <input type="checkbox"/> MOD 0825 (Ø 10) <input type="checkbox"/> MOD 0830 (Ø 12) <input type="checkbox"/> MOD 0835 (Ø 14) <input type="checkbox"/> MOD 0840 (Ø 16) <input type="checkbox"/> MOD 0834 (Ø 12) <input type="checkbox"/> MOD 0839 (Ø 12)	<table border="1"> <tbody> <tr> <td></td> <td></td> </tr> <tr> <td> W = _____ °</td> <td></td> </tr> <tr> <td> MOD 0834</td> <td></td> </tr> <tr> <td> MOD 0839</td> <td></td> </tr> <tr> <td></td> <td></td> </tr> </tbody> </table>			W = _____ °		MOD 0834		MOD 0839											
W = _____ °																					
MOD 0834																					
MOD 0839																					
<input type="checkbox"/> With bar holders 154 H1: _____ mm H2: _____ mm		Bar holders per post _____ pieces d = 12 mm	<table border="1"> <tbody> <tr> <td><input type="checkbox"/> Straight</td> <td></td> </tr> <tr> <td></td> <td></td> </tr> <tr> <td><input type="checkbox"/> Adjustable</td> <td></td> </tr> <tr> <td></td> <td></td> </tr> <tr> <td></td> <td></td> </tr> <tr> <td> W = _____ °</td> <td></td> </tr> <tr> <td></td> <td></td> </tr> <tr> <td> W = _____ °</td> <td></td> </tr> <tr> <td></td> <td></td> </tr> </tbody> </table>	<input type="checkbox"/> Straight				<input type="checkbox"/> Adjustable						W = _____ °				W = _____ °			
<input type="checkbox"/> Straight																					
<input type="checkbox"/> Adjustable																					
W = _____ °																					
W = _____ °																					

Sender

Name _____

Telephone _____

Company _____

Telefax _____

Street, house no. _____

E-mail _____

Postcode, city, country _____

Customer number _____



PREFIX

Q-line

Service

Enquiry form

MOD 0542 (H=970 mm)

- Ø 42,4 x 2,6 mm - 304
- Ø 42,4 x 2,6 mm - 316

MOD 0542











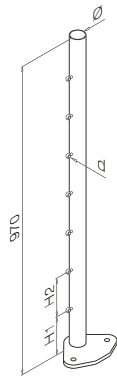

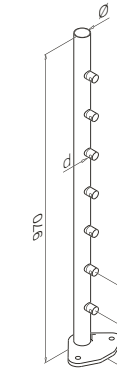

129

Specification

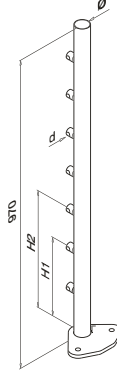
Type

Quantity

<input type="checkbox"/> For cable system 163 H1: _____ mm H2: _____ mm		Eye bolts per post _____ pieces d: <input type="checkbox"/> 3,2 mm <input type="checkbox"/> 6,0 mm	   W = _____ ° 	
<input type="checkbox"/> For cable system 166 - 167 H1: _____ mm H2: _____ mm		Cable holder _____ pieces d = 3,2 mm	  	
<input type="checkbox"/> For cable system 166 - 167 H1: _____ mm H2: _____ mm		Cable holder _____ pieces d = 3,2 mm	  	

Sender

Name _____

Telephone _____

Company _____

Telefax _____

Street, house no. _____

E-mail _____

Postcode, city, country _____

Customer number _____



PREFIX

Q-line

Service

Enquiry form

130

MOD 0944 MOD 0913
MOD 0914

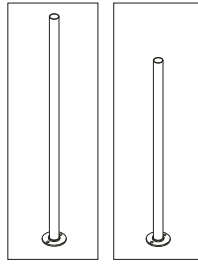

MOD 0944 (H=1150 mm)

MOD 0913 (H=970 mm)
 MOD 0914 (H=970 mm)

- Ø 42,4 x 2,0 mm - 304
- Ø 48,3 x 2,0 mm - 304
- Ø 42,4 x 2,0 mm - 316
- Ø 48,3 x 2,0 mm - 316

- Ø 42,4 x 2,6 mm - 304
- Ø 48,3 x 2,6 mm - 304
- Ø 42,4 x 2,6 mm - 316
- Ø 48,3 x 2,6 mm - 316
- Ø 42,4 x 2,0 mm - 304
- Ø 48,3 x 2,0 mm - 304
- Ø 42,4 x 2,0 mm - 316
- Ø 48,3 x 2,0 mm - 316

Specification

Type

Quantity

<input type="checkbox"/> With glass clamps 260 - 284 H1: _____ mm H2: _____ mm		Glass clamp <input type="checkbox"/> MOD 20 <input type="checkbox"/> MOD 21 <input type="checkbox"/> MOD 22 <input type="checkbox"/> MOD 24 <input type="checkbox"/> MOD 25 <input type="checkbox"/> MOD 26 <input type="checkbox"/> MOD 27 <input type="checkbox"/> MOD 28 <input type="checkbox"/> MOD 44 <input type="checkbox"/> MOD 46 <input type="checkbox"/> MOD 51 <input type="checkbox"/> MOD 52	Glass thickness <input type="checkbox"/> 6 mm <input type="checkbox"/> 6,76 mm <input type="checkbox"/> 8 mm <input type="checkbox"/> 8,38 mm <input type="checkbox"/> 8,76 mm <input type="checkbox"/> 9,52 mm <input type="checkbox"/> 10 mm <input type="checkbox"/> 10,76 mm <input type="checkbox"/> 11,52 mm <input type="checkbox"/> 12 mm <input type="checkbox"/> 12,76 mm		
<input type="checkbox"/> With Spider 291 H1: _____ mm H2: _____ mm		Spider <input type="checkbox"/> MOD 0750 <input type="checkbox"/> MOD 0751 <input type="checkbox"/> MOD 0752 <input type="checkbox"/> MOD 0753	Glass thickness <input type="checkbox"/> 8 - 13,52 mm		
<input type="checkbox"/> With crossbar holders 155 - 159 H1: _____ mm H2: _____ mm		Crossbar holders per post _____ pieces <input type="checkbox"/> MOD 0825 (Ø 10) <input type="checkbox"/> MOD 0830 (Ø 12) <input type="checkbox"/> MOD 0835 (Ø 14) <input type="checkbox"/> MOD 0840 (Ø 16) <input type="checkbox"/> MOD 0834 (Ø 12) <input type="checkbox"/> MOD 0839 (Ø 12)			

Sender

Name _____

Telephone _____

Company _____

Telefax _____

Street, house no. _____

E-mail _____

Postcode, city, country _____

Customer number _____



PREFIX

Q-line

Service

Enquiry form

130

MOD 0944 MOD 0913
MOD 0914

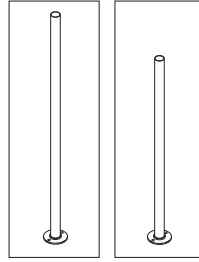

MOD 0944 (H=1150 mm)

MOD 0913 (H=970 mm)
 MOD 0914 (H=970 mm)

- Ø 42,4 x 2,0 mm - 304
- Ø 48,3 x 2,0 mm - 304
- Ø 42,4 x 2,0 mm - 316
- Ø 48,3 x 2,0 mm - 316

- Ø 42,4 x 2,6 mm - 304
- Ø 48,3 x 2,6 mm - 304
- Ø 42,4 x 2,6 mm - 316
- Ø 48,3 x 2,6 mm - 316
- Ø 42,4 x 2,0 mm - 304
- Ø 48,3 x 2,0 mm - 304
- Ø 42,4 x 2,0 mm - 316
- Ø 48,3 x 2,0 mm - 316

Specification

Type

Quantity

<input type="checkbox"/> With bar holders 154 H1: _____ mm H2: _____ mm		Bar holders per post _____ pieces d = 12 mm	<input type="checkbox"/> Straight <input type="checkbox"/> Adjustable 	 W = _____ °	
<input type="checkbox"/> For cable system 163 H1: _____ mm H2: _____ mm		Eye bolts per post _____ pieces d: <input type="checkbox"/> 3,2 mm <input type="checkbox"/> 6,0 mm	 W = _____ °		
<input type="checkbox"/> For cable system 166 - 167 H1: _____ mm H2: _____ mm		Cable holder _____ pieces d = 3,2 mm	 W = _____ ° 		

Sender

Name _____

Telephone _____

Company _____

Telefax _____

Street, house no. _____

E-mail _____

Postcode, city, country _____

Customer number _____



PREFIX

Q-line

Service

Enquiry form

MOD 0564 (H=1150 mm)

MOD 0544 (H=970 mm)

Ø 42,4 x 2,0 mm - 304

Ø 42,4 x 2,6 mm - 304

Ø 48,3 x 2,6 mm - 304

MOD 0564 MOD 0544

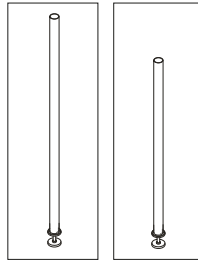

137

Specification

Type

Quantity

<input type="checkbox"/> With glass clamps 260 - 284 H1: _____ mm H2: _____ mm		Glass clamp <input type="checkbox"/> MOD 20 <input type="checkbox"/> MOD 21 <input type="checkbox"/> MOD 22 <input type="checkbox"/> MOD 24 <input type="checkbox"/> MOD 25 <input type="checkbox"/> MOD 26 <input type="checkbox"/> MOD 27 <input type="checkbox"/> MOD 28 <input type="checkbox"/> MOD 44 <input type="checkbox"/> MOD 46 <input type="checkbox"/> MOD 51 <input type="checkbox"/> MOD 52	Glass thickness <input type="checkbox"/> 6 mm <input type="checkbox"/> 6,76 mm <input type="checkbox"/> 8 mm <input type="checkbox"/> 8,38 mm <input type="checkbox"/> 8,76 mm <input type="checkbox"/> 9,52 mm <input type="checkbox"/> 10 mm <input type="checkbox"/> 10,76 mm <input type="checkbox"/> 11,52 mm <input type="checkbox"/> 12 mm <input type="checkbox"/> 12,76 mm		
<input type="checkbox"/> With glass clamps 260 - 284 H1: _____ mm H2: _____ mm H3: _____ mm H4: _____ mm		Glass clamp <input type="checkbox"/> MOD 20 <input type="checkbox"/> MOD 21 <input type="checkbox"/> MOD 22 <input type="checkbox"/> MOD 24 <input type="checkbox"/> MOD 25 <input type="checkbox"/> MOD 26 <input type="checkbox"/> MOD 27 <input type="checkbox"/> MOD 28 <input type="checkbox"/> MOD 44 <input type="checkbox"/> MOD 46 <input type="checkbox"/> MOD 51 <input type="checkbox"/> MOD 52	Glass thickness <input type="checkbox"/> 6 mm <input type="checkbox"/> 6,76 mm <input type="checkbox"/> 8 mm <input type="checkbox"/> 8,38 mm <input type="checkbox"/> 8,76 mm <input type="checkbox"/> 9,52 mm <input type="checkbox"/> 10 mm <input type="checkbox"/> 10,76 mm <input type="checkbox"/> 11,52 mm <input type="checkbox"/> 12 mm <input type="checkbox"/> 12,76 mm		
<input type="checkbox"/> With Spider 291 H1: _____ mm H2: _____ mm		Spider <input type="checkbox"/> MOD 0750 <input type="checkbox"/> MOD 0751 <input type="checkbox"/> MOD 0752 <input type="checkbox"/> MOD 0753	Glass thickness <input type="checkbox"/> 8 - 13,52 mm		

Sender

Name _____

Telephone _____

Company _____

Telefax _____

Street, house no. _____

E-mail _____

Postcode, city, country _____

Customer number _____



PREFIX

Q-line

Service

Enquiry form

MOD 0564 (H=1150 mm)

MOD 0544 (H=970 mm)

Ø 42,4 x 2,0 mm - 304

Ø 42,4 x 2,6 mm - 304

Ø 48,3 x 2,6 mm - 304

MOD 0564

MOD 0544



137

Specification

Type

Quantity

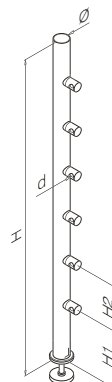
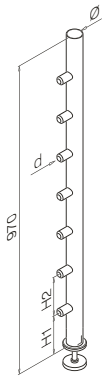
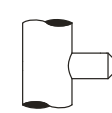
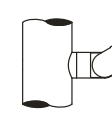
<input type="checkbox"/> With crossbar holders 155 - 159 H1: _____ mm H2: _____ mm		Crossbar holders per post _____ pieces <input type="checkbox"/> MOD 0825 (Ø 10) <input type="checkbox"/> MOD 0830 (Ø 12) <input type="checkbox"/> MOD 0835 (Ø 14) <input type="checkbox"/> MOD 0840 (Ø 16) <input type="checkbox"/> MOD 0834 (Ø 12) <input type="checkbox"/> MOD 0839 (Ø 12)	<table border="1"> <tr><td></td><td></td></tr> <tr><td></td><td>W = _____ °</td></tr> <tr><td></td><td>MOD 0834</td></tr> <tr><td></td><td>MOD 0839</td></tr> </table>				W = _____ °		MOD 0834		MOD 0839	<table border="1"> <tr><td></td><td></td></tr> <tr><td></td><td></td></tr> <tr><td></td><td></td></tr> <tr><td></td><td></td></tr> </table>									
	W = _____ °																				
	MOD 0834																				
	MOD 0839																				
<input type="checkbox"/> With bar holders 154 H1: _____ mm H2: _____ mm		Bar holders per post _____ pieces d = 12 mm	<input type="checkbox"/> Straight  <input type="checkbox"/> Adjustable 	<table border="1"> <tr><td></td><td></td></tr> <tr><td></td><td>W = _____ °</td></tr> <tr><td></td><td></td></tr> <tr><td></td><td>W = _____ °</td></tr> </table>				W = _____ °				W = _____ °	<table border="1"> <tr><td></td><td></td></tr> <tr><td></td><td></td></tr> <tr><td></td><td></td></tr> <tr><td></td><td></td></tr> </table>								
	W = _____ °																				
	W = _____ °																				

Sender

Name _____

Telephone _____

Company _____

Telefax _____

Street, house no. _____

E-mail _____

Postcode, city, country _____

Customer number _____



PREFIX

Q-line

Service

Enquiry form

137

MOD 0564 MOD 0544

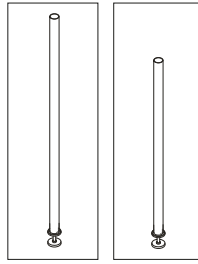

MOD 0564 (H=1150 mm)

MOD 0544 (H=970 mm)

Ø 42,4 x 2,0 mm - 304

Ø 42,4 x 2,6 mm - 304

Ø 48,3 x 2,6 mm - 304

Specification

Type

Quantity

<input type="checkbox"/> For cable system 163 H1: _____ mm H2: _____ mm		Eye bolts per post _____ pieces d: <input type="checkbox"/> 3,2 mm <input type="checkbox"/> 6,0 mm	 W = _____ °	
<input type="checkbox"/> For cable system 166 - 167 H1: _____ mm H2: _____ mm		Cable holder _____ pieces d = 3,2 mm	 W = _____ °	

Sender

Name _____

Telephone _____

Company _____

Telefax _____

Street, house no. _____

E-mail _____

Postcode, city, country _____

Customer number _____



PREFIX

Q-line

Service

Enquiry form

**140,
213**

MOD 0551



MOD 0552



MOD 0553

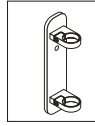

MOD 0555



- MOD 0551 (304, 316)
- MOD 0552 (304, 316)
- MOD 0553 (304)
- MOD 0555 (304, 316)

- MOD 0551 (304, 316)
- MOD 0552 (304, 316)
- MOD 0553 (304)
- MOD 0555 (304, 316)

- Ø 42,4 x 2,0 mm - 304
- Ø 48,3 x 2,0 mm - 304
- Ø 42,4 x 2,0 mm - 316
- Ø 48,3 x 2,0 mm - 316

- Ø 42,4 x 2,6 mm - 304
- Ø 48,3 x 2,6 mm - 304
- Ø 42,4 x 2,6 mm - 316
- Ø 48,3 x 2,6 mm - 316

Specification

Type

Quantity

<input type="checkbox"/> With glass clamps 260 - 284 H: _____ mm H1: _____ mm H2: _____ mm		Glass clamp <input type="checkbox"/> MOD 20 <input type="checkbox"/> MOD 21 <input type="checkbox"/> MOD 22 <input type="checkbox"/> MOD 24 <input type="checkbox"/> MOD 25 <input type="checkbox"/> MOD 26 <input type="checkbox"/> MOD 27 <input type="checkbox"/> MOD 28 <input type="checkbox"/> MOD 44 <input type="checkbox"/> MOD 46 <input type="checkbox"/> MOD 51 <input type="checkbox"/> MOD 52	Glass thickness <input type="checkbox"/> 6 mm <input type="checkbox"/> 6,76 mm <input type="checkbox"/> 8 mm <input type="checkbox"/> 8,38 mm <input type="checkbox"/> 8,76 mm <input type="checkbox"/> 9,52 mm <input type="checkbox"/> 10 mm <input type="checkbox"/> 10,76 mm <input type="checkbox"/> 11,52 mm <input type="checkbox"/> 12 mm <input type="checkbox"/> 12,76 mm		
<input type="checkbox"/> With Spider 291 H: _____ mm H1: _____ mm H2: _____ mm		Spider <input type="checkbox"/> MOD 0750 <input type="checkbox"/> MOD 0751 <input type="checkbox"/> MOD 0752 <input type="checkbox"/> MOD 0753	Glass thickness <input type="checkbox"/> 8 - 13,52 mm		
<input type="checkbox"/> With crossbar holders 155 - 159 H: _____ mm H1: _____ mm H2: _____ mm		Crossbar holders per post _____ pieces <input type="checkbox"/> MOD 0825 (Ø 10) <input type="checkbox"/> MOD 0830 (Ø 12) <input type="checkbox"/> MOD 0835 (Ø 14) <input type="checkbox"/> MOD 0840 (Ø 16) <input type="checkbox"/> MOD 0834 (Ø 12) <input type="checkbox"/> MOD 0839 (Ø 12)			

Sender

Name

Telephone

Company

Telefax

Street, house no.

E-mail

Postcode, city, country

Customer number



PREFIX

Q-line

140,
213

MOD 0551 MOD 0552

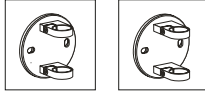

MOD 0553 MOD 0555

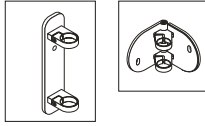

Service

Enquiry form

- MOD 0551 (304, 316)
- MOD 0552 (304, 316)
- MOD 0553 (304)
- MOD 0555 (304, 316)

- MOD 0551 (304, 316)
- MOD 0552 (304, 316)
- MOD 0553 (304)
- MOD 0555 (304, 316)

- Ø 42,4 x 2,0 mm - 304
- Ø 48,3 x 2,0 mm - 304
- Ø 42,4 x 2,0 mm - 316
- Ø 48,3 x 2,0 mm - 316

- Ø 42,4 x 2,6 mm - 304
- Ø 48,3 x 2,6 mm - 304
- Ø 42,4 x 2,6 mm - 316
- Ø 48,3 x 2,6 mm - 316

Specification

Type

Quantity

<input type="checkbox"/> With bar holders 154 H: _____ mm H1: _____ mm H2: _____ mm		Bar holders per post _____ pieces d = 12 mm	<input type="checkbox"/> Straight <input type="checkbox"/> Adjustable 	Straight 	Adjustable 	
<input type="checkbox"/> For cable system 163 H: _____ mm H1: _____ mm H2: _____ mm		Eye bolts per post _____ pieces d: <input type="checkbox"/> 3,2 mm <input type="checkbox"/> 6,0 mm				
<input type="checkbox"/> For cable system 166 - 167 H: _____ mm H1: _____ mm H2: _____ mm		Cable holder _____ pieces d = 3,2 mm				

Sender

Name _____

Company _____

Street, house no. _____

Postcode, city, country _____

Telephone _____

Telefax _____

E-mail _____

Customer number _____



PREFIX

Square Line®

Service

Enquiry form

MOD 4913 (H=970 mm)

- 40 x 40 x 2,0 mm - 304
- 40 x 40 x 2,0 mm - 316

MOD 4913



102

Specification

Type

Quantity

<input type="checkbox"/> With glass clamps 260 - 284 H1: _____ mm H2: _____ mm		Glass clamp <input type="checkbox"/> MOD 20 <input type="checkbox"/> MOD 21 <input type="checkbox"/> MOD 22 <input type="checkbox"/> MOD 24 <input type="checkbox"/> MOD 25 <input type="checkbox"/> MOD 26 <input type="checkbox"/> MOD 27 <input type="checkbox"/> MOD 28 <input type="checkbox"/> MOD 44 <input type="checkbox"/> MOD 46 <input type="checkbox"/> MOD 51 <input type="checkbox"/> MOD 52	Glass thickness <input type="checkbox"/> 6 mm <input type="checkbox"/> 6,76 mm <input type="checkbox"/> 8 mm <input type="checkbox"/> 8,38 mm <input type="checkbox"/> 8,76 mm <input type="checkbox"/> 9,52 mm <input type="checkbox"/> 10 mm <input type="checkbox"/> 10,76 mm <input type="checkbox"/> 11,52 mm <input type="checkbox"/> 12 mm <input type="checkbox"/> 12,76 mm		
<input type="checkbox"/> With Spider 290 - 291 H1: _____ mm H2: _____ mm		Spider <input type="checkbox"/> MOD 0750 <input type="checkbox"/> MOD 0751 <input type="checkbox"/> MOD 0752 <input type="checkbox"/> MOD 0753 <input type="checkbox"/> MOD 4752 <input type="checkbox"/> MOD 4753	Glass thickness <input type="checkbox"/> 8 - 13,52 mm		

Sender

Name _____

Telephone _____

Company _____

Telefax _____

Street, house no. _____

E-mail _____

Postcode, city, country _____

Customer number _____



PREFIX

Square Line®

Service

Enquiry form

MOD 4913 (H=970 mm)

MOD 4901 (H=1000 mm)

40 x 40 x 2,0 mm - 304

40 x 40 x 2,0 mm - 316

60 x 30 x 2,6 mm - 316

MOD 4913

MOD 4901

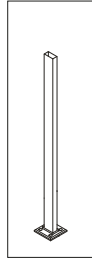
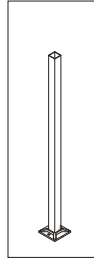

102

Specification

Type

Quantity

<input type="checkbox"/> With crossbar holders 109 H1: _____ mm H2: _____ mm		Crossbar holders per post _____ pieces <input type="checkbox"/> MOD 4820 <input type="checkbox"/> MOD 4821 <input type="checkbox"/> MOD 4822 <input type="checkbox"/> MOD 4823		
<input type="checkbox"/> For cable system 163 H1: _____ mm H2: _____ mm		Eye bolts per post _____ pieces d: <input type="checkbox"/> 3,2 mm <input type="checkbox"/> 6,0 mm		

Sender

Name _____

Telephone _____

Company _____

Telefax _____

Street, house no. _____

E-mail _____

Postcode, city, country _____

Customer number _____



PREFIX

Square Line®

Service

Enquiry form

MOD 4551

MOD 4555

- 40 x 40 x 2,0 mm - 304
- 40 x 40 x 2,0 mm - 316

- 40 x 40 x 2,0 mm - 304
- 40 x 40 x 2,0 mm - 316

MOD 4551



MOD 4555

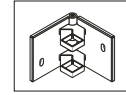

107

Specification

Type

Quantity

<input type="checkbox"/> With glass clamps 260 - 284 H: _____ mm H1: _____ mm H2: _____ mm		Glass clamp <input type="checkbox"/> MOD 20 <input type="checkbox"/> MOD 21 <input type="checkbox"/> MOD 22 <input type="checkbox"/> MOD 24 <input type="checkbox"/> MOD 25 <input type="checkbox"/> MOD 26 <input type="checkbox"/> MOD 27 <input type="checkbox"/> MOD 28 <input type="checkbox"/> MOD 44 <input type="checkbox"/> MOD 46 <input type="checkbox"/> MOD 51 <input type="checkbox"/> MOD 52	Glass thickness <input type="checkbox"/> 6 mm <input type="checkbox"/> 6,76 mm <input type="checkbox"/> 8 mm <input type="checkbox"/> 8,38 mm <input type="checkbox"/> 8,76 mm <input type="checkbox"/> 9,52 mm <input type="checkbox"/> 10 mm <input type="checkbox"/> 10,76 mm <input type="checkbox"/> 11,52 mm <input type="checkbox"/> 12 mm <input type="checkbox"/> 12,76 mm		
<input type="checkbox"/> With crossbar holders 109 H: _____ mm H1: _____ mm H2: _____ mm		Crossbar holders per post _____ pieces <input type="checkbox"/> MOD 4820 <input type="checkbox"/> MOD 4821 <input type="checkbox"/> MOD 4822 <input type="checkbox"/> MOD 4823			
<input type="checkbox"/> For cable system 163 H: _____ mm H1: _____ mm H2: _____ mm		Eye bolts per post _____ pieces d: <input type="checkbox"/> 3,2 mm <input type="checkbox"/> 6,0 mm			

Sender

Name

Telephone

Company

Telefax

Street, house no.

E-mail

Postcode, city, country

Customer number







DRILLING

(round tube)

Service

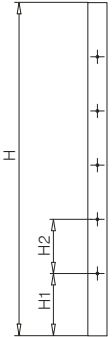
Enquiry form

All 2D bent products arrive 100% ready for mounting - cut to length, shaped to your requirements and specially treated.

Specification	Type	Quantity		Threading			
		Quantity	Quantity	Threading	M6	M8	M10
<input type="checkbox"/> <p>H: _____ mm</p> <p>H1: _____ mm</p> <p>H2: _____ mm</p> <p>W1: _____ °</p> 	<p>H1/H2</p> <p><input type="checkbox"/> </p> <p><input type="checkbox"/> </p>	<p>∅</p> <p>∅ 33,7 x 2,0 mm</p> <p>∅ 42,4 x 2,0 mm</p> <p>∅ 42,4 x 2,6 mm</p> <p>∅ 48,3 x 2,0 mm</p> <p>∅ 48,3 x 2,6 mm</p> <p>∅ 60,3 x 2,0 mm</p>	<p>Tube</p>	<p>Drilling holes</p> <p> ∅ mm</p>	<p><input type="checkbox"/></p> <p><input type="checkbox"/></p> <p><input type="checkbox"/></p> <p><input type="checkbox"/></p> <p><input type="checkbox"/></p> <p><input type="checkbox"/></p>	<p><input type="checkbox"/></p> <p><input type="checkbox"/></p> <p><input type="checkbox"/></p> <p><input type="checkbox"/></p> <p><input type="checkbox"/></p>	<p><input type="checkbox"/></p> <p><input type="checkbox"/></p> <p><input type="checkbox"/></p> <p><input type="checkbox"/></p> <p><input type="checkbox"/></p>



Sender

Name

Telephone

Company

Telefax

Street, house no.

E-mail

Postcode, city, country

Customer number



MILLING / CUTTING

(round tube for LED-spotlights)

Service
Enquiry form

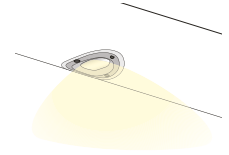

		2500 mm	5000 mm	304 Satin	316 Satin
○	Ø 42,4 x 2,0 mm	<input type="checkbox"/>	<input type="checkbox"/>	<input type="checkbox"/>	<input type="checkbox"/>
○	Ø 48,3 x 2,0 mm	<input type="checkbox"/>	<input type="checkbox"/>	<input type="checkbox"/>	<input type="checkbox"/>
Quantity: _____					

LED-spotlight now also in a bended tube. Contact us!

MILLING

(holes for LED-spotlights)

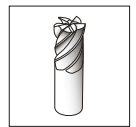

<p>L = _____ mm L₁ = _____ mm (min. 55) L₂ = _____ mm Quantity: _____</p>	
---	--

CUTTING

(tube with predrilled holes for LED-spotlights)

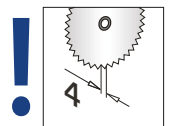

<p>X = 90° L₁ = _____ mm L₂ = _____ mm</p>	
--	--

For cutting at an angle, please contact us!

Shipment will always include the waste parts.

Sender	
Name	Telephone
Company	Telefax
Street, house no.	E-mail
Postcode, city, country	Customer number



CUTTING

(square bars and tubes)

Service

Enquiry form

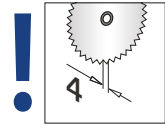

		2500 mm	5000 mm	304 Satin	316 Satin
	15 x 5 mm	<input type="checkbox"/>	<input type="checkbox"/>	<input type="checkbox"/>	<input type="checkbox"/>
	40 x 10 x 1,5 mm	<input type="checkbox"/>	<input type="checkbox"/>	<input type="checkbox"/>	<input type="checkbox"/>
	40 x 40 x 2,0 mm	<input type="checkbox"/>	<input type="checkbox"/>	<input type="checkbox"/>	<input type="checkbox"/>
	60 x 30 x 2,6 mm		<input type="checkbox"/>		<input type="checkbox"/>
	60 x 20 x 2,0 mm	<input type="checkbox"/>	<input type="checkbox"/>		<input type="checkbox"/>
Quantity: _____					

Cut

$X = 90^\circ$ $L_1 = \text{_____ mm}$ $L_2 = \text{_____ mm}$	
--	--

Mitre cut

$X = \text{_____}^\circ$ $L_1 = \text{_____ mm}$ $L_2 = \text{_____ mm}$		
--	--	--

Mitre cut

$X = \text{_____}^\circ$ $L_1 = \text{_____ mm}$ $L_2 = \text{_____ mm}$		
--	--	--



Sender

Name _____

Telephone _____

Company _____

Telefax _____

Street, house no. _____

E-mail _____

Postcode, city, country _____

Customer number _____



CUTTING

(round bars and tubes)

Service
Enquiry form

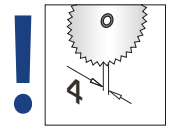

		2500 mm	3000 mm	5000 mm	304 Satin	316 Satin	304 Polished	316 Polished	Carbon steel
●	Ø 10 mm	<input type="checkbox"/>		<input type="checkbox"/>	<input type="checkbox"/>				
●	Ø 12 mm	<input type="checkbox"/>		<input type="checkbox"/>	<input type="checkbox"/>	<input type="checkbox"/>	<input type="checkbox"/>	<input type="checkbox"/>	
●	Ø 14 mm	<input type="checkbox"/>		<input type="checkbox"/>	<input type="checkbox"/>				
○	Ø 12 x 1,0 mm	<input type="checkbox"/>		<input type="checkbox"/>	<input type="checkbox"/>				
○	Ø 14 x 1,0 mm	<input type="checkbox"/>		<input type="checkbox"/>	<input type="checkbox"/>				
○	Ø 16 x 1,0 mm	<input type="checkbox"/>		<input type="checkbox"/>	<input type="checkbox"/>	<input type="checkbox"/>			
○	Ø 33,7 x 2,0 mm	<input type="checkbox"/>		<input type="checkbox"/>	<input type="checkbox"/>				
○	Ø 38 x 1,5 mm		<input type="checkbox"/>			<input type="checkbox"/>			
○	Ø 42,4 x 1,5 mm	<input type="checkbox"/>		<input type="checkbox"/>	<input type="checkbox"/>	<input type="checkbox"/> *			
○	Ø 42,4 x 2,6 mm	<input type="checkbox"/>		<input type="checkbox"/>	<input type="checkbox"/>	<input type="checkbox"/>			
○	Ø 48,3 x 2,0 mm	<input type="checkbox"/>		<input type="checkbox"/>	<input type="checkbox"/>	<input type="checkbox"/>			<input type="checkbox"/>
○	Ø 48,3 x 2,6 mm	<input type="checkbox"/>		<input type="checkbox"/>	<input type="checkbox"/>	<input type="checkbox"/>	<input type="checkbox"/>	<input type="checkbox"/>	
○	Ø 60,3 x 2,0 mm	<input type="checkbox"/>		<input type="checkbox"/>	<input type="checkbox"/>				

Quantity: _____ * only available in 5000mm length

Cut

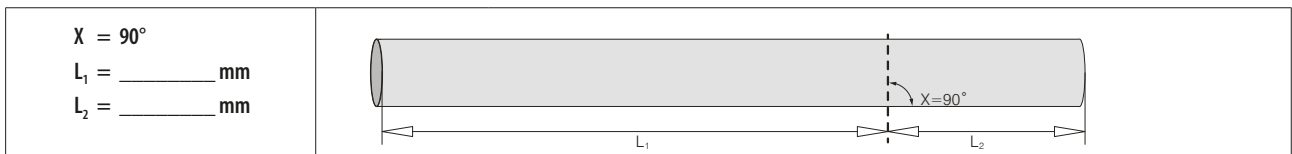

Mitre cut

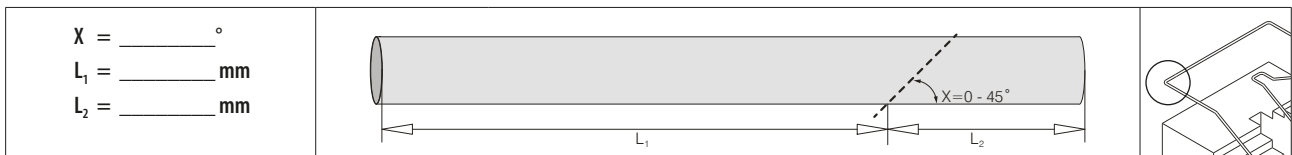

Sender

Name

Telephone

Company

Telefax

Street, house no.

E-mail

Postcode, city, country

Customer number



CUTTING

(U-profile)

Service

Enquiry form

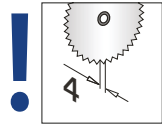

		2500 mm	5000 mm	316 Satin	Aluminium
	17,25 x 15 x 2,0 mm	<input type="checkbox"/>	<input type="checkbox"/>		<input type="checkbox"/>
	30 x 27 x 3,0 mm		<input type="checkbox"/>	<input type="checkbox"/>	
	22 x 20 x 2,0 mm	<input type="checkbox"/>	<input type="checkbox"/>		<input type="checkbox"/>
	26 x 20 x 2,0 mm	<input type="checkbox"/>	<input type="checkbox"/>		<input type="checkbox"/>
Quantity: _____					

Cut

$X = 90^\circ$ $L_1 = \text{_____ mm}$ $L_2 = \text{_____ mm}$	
--	--

Mitre cut

$X = \text{_____}^\circ$ $L_1 = \text{_____ mm}$ $L_2 = \text{_____ mm}$		
$X = \text{_____}^\circ$ $L_1 = \text{_____ mm}$ $L_2 = \text{_____ mm}$		

Mitre cut

$X = \text{_____}^\circ$ $L_1 = \text{_____ mm}$ $L_2 = \text{_____ mm}$		
$X = \text{_____}^\circ$ $L_1 = \text{_____ mm}$ $L_2 = \text{_____ mm}$		



Sender

Name _____

Telephone _____

Company _____

Telefax _____

Street, house no. _____

E-mail _____

Postcode, city, country _____

Customer number _____



CUTTING

(cap rails)

Service
Enquiry form

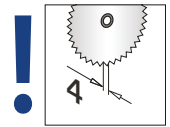

		2500 mm	5000 mm	304 Satin	316 Satin	304 Polished	316 Polished
	Ø 30 x 1,5 mm	<input type="checkbox"/>	<input type="checkbox"/>	<input type="checkbox"/>	<input type="checkbox"/>		
	Ø 42,4 x 1,5 mm	<input type="checkbox"/>	<input type="checkbox"/>	<input type="checkbox"/>	<input type="checkbox"/>	<input type="checkbox"/>	<input type="checkbox"/>
	Ø 48,3 x 1,5 mm	<input type="checkbox"/>	<input type="checkbox"/>	<input type="checkbox"/>	<input type="checkbox"/>	<input type="checkbox"/>	<input type="checkbox"/>
	Ø 60,3 x 1,5 mm	<input type="checkbox"/>	<input type="checkbox"/>	<input type="checkbox"/>	<input type="checkbox"/>		
	80 x 40 x 1,5 mm *	<input type="checkbox"/>	<input type="checkbox"/>	<input type="checkbox"/>			
	110 x 40 x 1,5 mm *	<input type="checkbox"/>	<input type="checkbox"/>	<input type="checkbox"/>			
	40 x 40 x 1,5 mm	<input type="checkbox"/>	<input type="checkbox"/>	<input type="checkbox"/>	<input type="checkbox"/>		
	60 x 40 x 1,5 mm	<input type="checkbox"/>	<input type="checkbox"/>	<input type="checkbox"/>	<input type="checkbox"/>		
Quantity: _____							* Mitre cut 0 - 30°

Cut

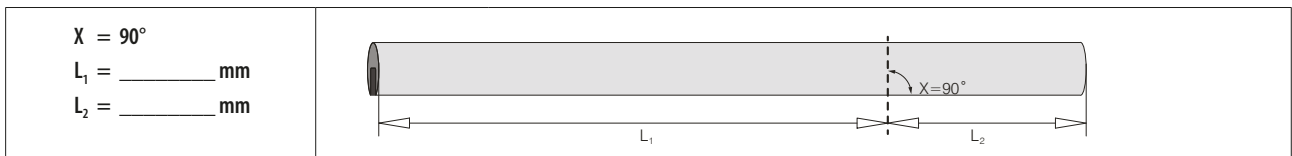

Mitre cut

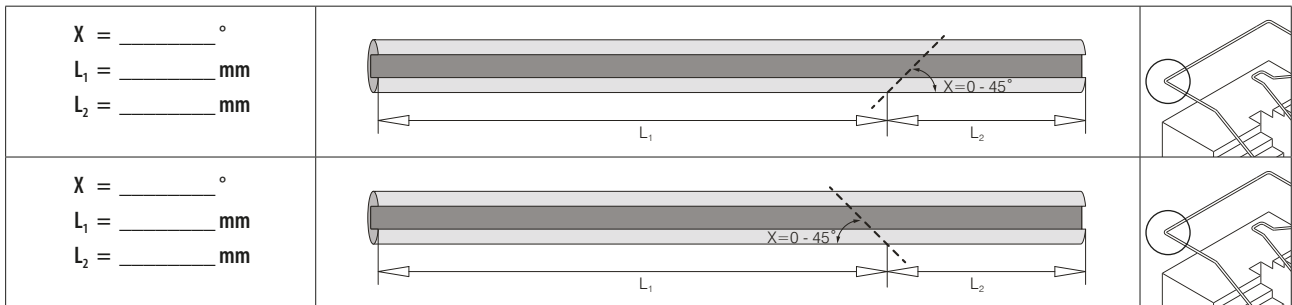

Mitre cut

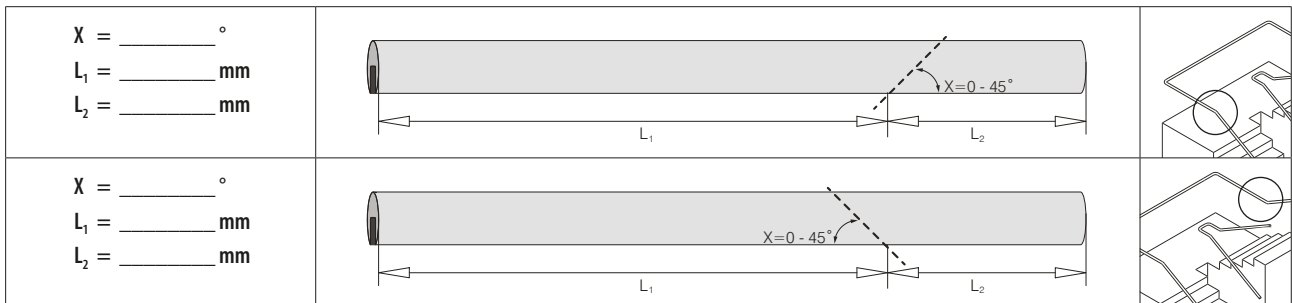

Sender

Name

Telephone

Company

Telefax

Street, house no.

E-mail

Postcode, city, country

Customer number



CUTTING

(cap rails, wood)

Service

Enquiry form

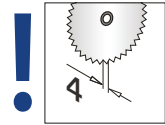

		2500 mm	3600 mm	6600 mm	Beech untreated wood	Beech P11 stained and lacquered	Beech lacquered	Oak lacquered	Cedar untreated wood
●	∅ 42,0 mm*		<input type="checkbox"/> *	<input type="checkbox"/> *	<input type="checkbox"/>				
●	∅ 42,0 mm	<input type="checkbox"/>			<input type="checkbox"/>	<input type="checkbox"/>	<input type="checkbox"/>	<input type="checkbox"/>	<input type="checkbox"/>
●	∅ 48,0 mm	<input type="checkbox"/>			<input type="checkbox"/>				
◐	∅ 42,0 mm	<input type="checkbox"/>				<input type="checkbox"/>	<input type="checkbox"/>	<input type="checkbox"/>	
◑	60 x 40 mm	<input type="checkbox"/>					<input type="checkbox"/>	<input type="checkbox"/>	
Quantity: _____									* Bendywood

Cut

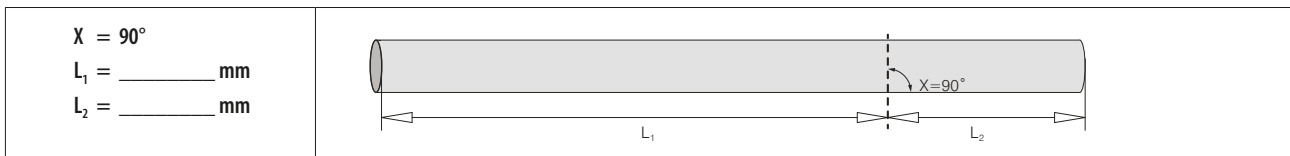

Mitre cut

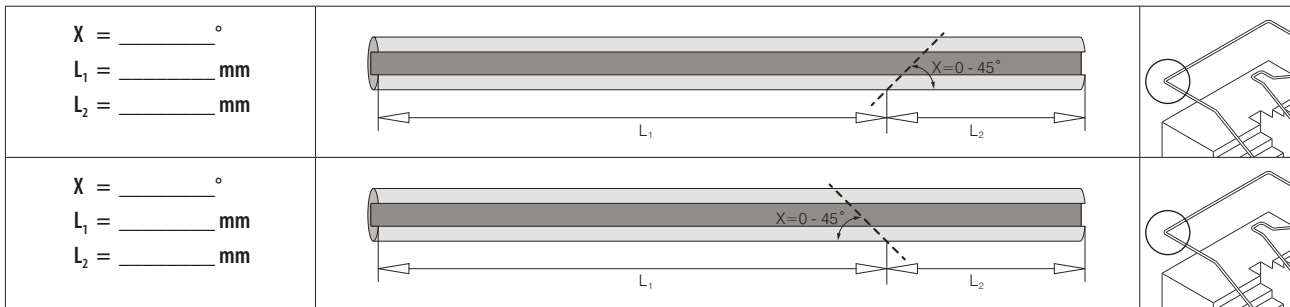

Mitre cut

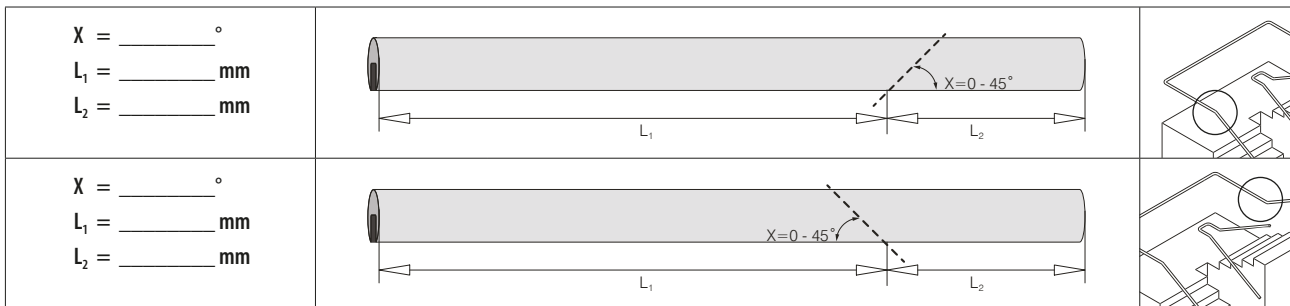

Q-railing®

Sender

Name

Telephone

Company

Telefax

Street, house no.

E-mail

Postcode, city, country

Customer number



CUTTING

Base shoes, top mount

Service
Enquiry form

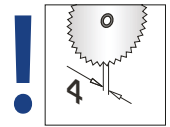

19,28

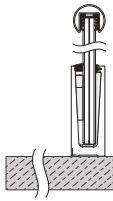

	SLIM 6904	SLIM 6914	3kN 6908
H x B (mm)	121 x 45	121 x 45	128 x 71
2500 mm	<input type="checkbox"/>		<input type="checkbox"/>
5000 mm	<input type="checkbox"/>	<input type="checkbox"/>	

1 Specification Quantity

<input type="checkbox"/>	L: _____ mm	_____ pc.		
--------------------------	-------------	-----------	--	--

2 Specification Quantity

<input type="checkbox"/>	W: _____ °	_____ pc.		
--------------------------	------------	-----------	--	--

Service
5



Sender

Name _____

Telephone _____

Company _____

Telefax _____

Street, house no. _____

E-mail _____

Postcode, city, country _____

Customer number _____



CUTTING

Base shoes, top mount

Service
Enquiry form

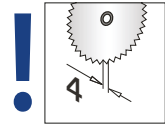

19,28

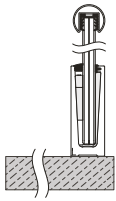

	SLIM 6904	SLIM 6914	3kN 6908
H x B (mm)	121 x 45	121 x 45	128 x 71
2500 mm	<input type="checkbox"/>		<input type="checkbox"/>
5000 mm	<input type="checkbox"/>	<input type="checkbox"/>	

3

Specification

Quantity

L1: _____ mm _____ pc.

L2: _____ mm

L3: _____ mm

4

Specification

Quantity

W: _____ ° _____ pc.

L1: _____ mm

L2: _____ mm

Q-railing®

Sender

Name _____

Telephone _____

Company _____

Telefax _____

Street, house no. _____

E-mail _____

Postcode, city, country _____

Customer number _____



CUTTING

Base shoes, top mount

Service
Enquiry form

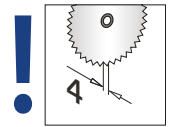

19,28

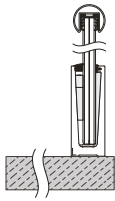

5 Specification Quantity

	SLIM 6904	SLIM 6914	3kN 6908
H x B (mm)	121 x 45	121 x 45	128 x 71
2500 mm	<input type="checkbox"/>		<input type="checkbox"/>
5000 mm	<input type="checkbox"/>	<input type="checkbox"/>	



L1: _____ mm _____ pc.

L2: _____ mm

L3: _____ mm



Sender

Name _____

Telephone _____

Company _____

Telefax _____

Street, house no. _____

E-mail _____

Postcode, city, country _____

Customer number _____



CUTTING

Base shoes, fascia mount

Service
Enquiry form

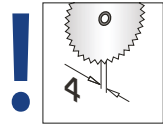

22, 32

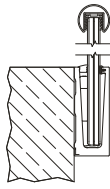

	SLIM 6905	3kN 6907
H x B (mm)	121 x 45	128 x 71
2500 mm	<input type="checkbox"/>	<input type="checkbox"/>
5000 mm	<input type="checkbox"/>	<input type="checkbox"/>

6

Specification

Quantity

L: _____ mm _____ pc.

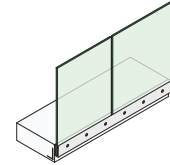
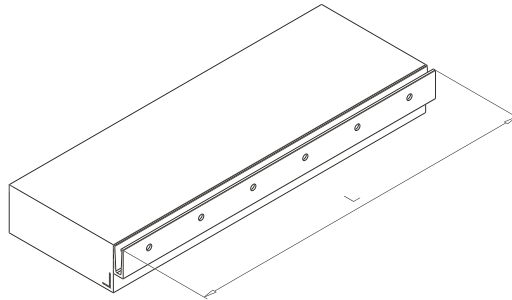

7

Specification

Quantity

W: _____ ° _____ pc.

L1: _____ mm

L2: _____ mm

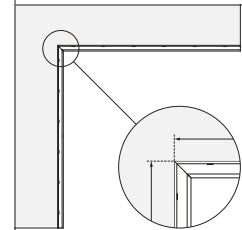
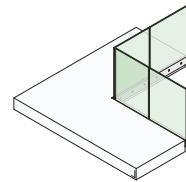
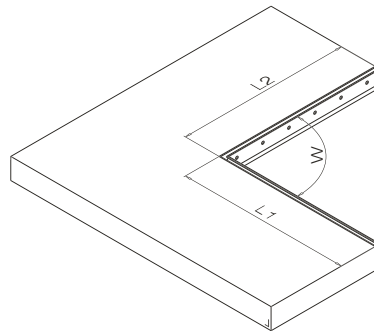

Q-railing®

Sender

Name _____

Telephone _____

Company _____

Telefax _____

Street, house no. _____

E-mail _____

Postcode, city, country _____

Customer number _____



CUTTING

Base shoes, fascia mount

Service
Enquiry form

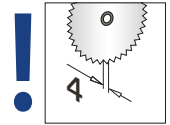

22, 32

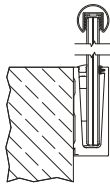

	SLIM 6905	3kN 6907
H x B (mm)	121 x 45	128 x 71
2500 mm	<input type="checkbox"/>	<input type="checkbox"/>
5000 mm	<input type="checkbox"/>	<input type="checkbox"/>

8

Specification

Quantity

L1: _____ mm _____ pc.
 L2: _____ mm
 L3: _____ mm

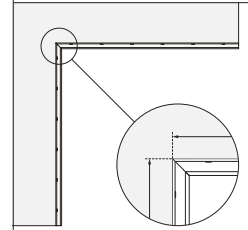
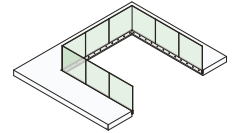
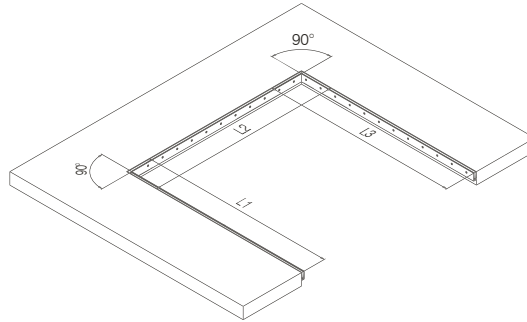

9

Specification

Quantity

W: _____ ° _____ pc.
 L1: _____ mm
 L2: _____ mm

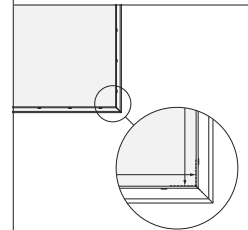
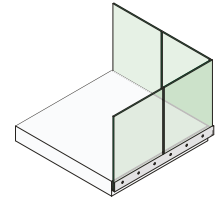
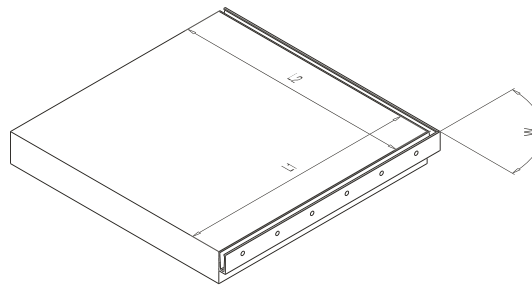

Service

5



Sender

Name

Telephone

Company

Telefax

Street, house no.

E-mail

Postcode, city, country

Customer number



CUTTING

Base shoes, fascia mount

Service

Enquiry form

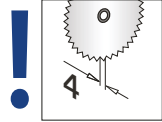

22, 32

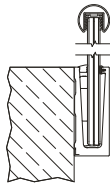

	SLIM 6905	3kN 6907
H x B (mm)	121 x 45	128 x 71
2500 mm	<input type="checkbox"/>	<input type="checkbox"/>
5000 mm	<input type="checkbox"/>	

10

Specification

Quantity



L1: _____ mm _____ pc.

L2: _____ mm

L3: _____ mm

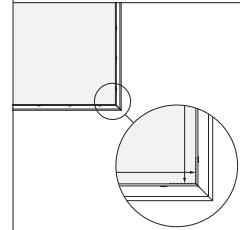
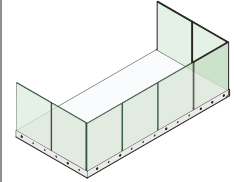
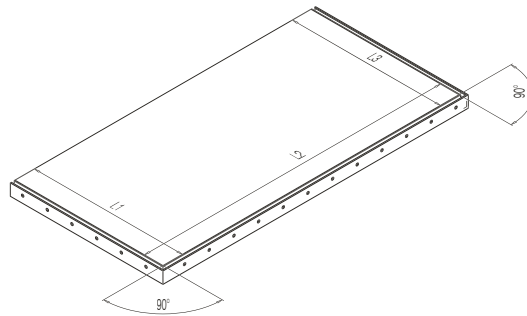

Sender

Name

Telephone

Company

Telefax

Street, house no.

E-mail

Postcode, city, country

Customer number



CUTTING

Base shoes, top mount for stairs

Service
Enquiry form

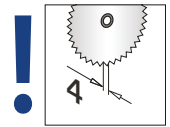

19,28

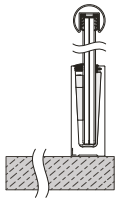

	SLIM 6904	SLIM 6914	3kN 6908
H x B (mm)	121 x 45	121 x 45	128 x 71
2500 mm	<input type="checkbox"/>		<input type="checkbox"/>
5000 mm	<input type="checkbox"/>	<input type="checkbox"/>	

11 Specification Quantity

<p>W: _____ ° _____ pc.</p> <p>H: _____ mm</p> <p>L1: _____ mm</p> <p>L2: _____ mm</p>		
---	--	----------

12 Specification Quantity

<p>W: _____ ° _____ pc.</p> <p>H: _____ mm</p> <p>L1: _____ mm</p> <p>L2: _____ mm</p>		
---	--	----------

Service
5



Sender

Name _____

Telephone _____

Company _____

Telefax _____

Street, house no. _____

E-mail _____

Postcode, city, country _____

Customer number _____



CUTTING

Base shoes, fascia mount for stairs

Service
Enquiry form

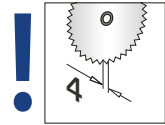

22, 32

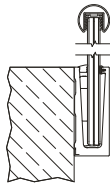

	SLIM 6905	3kN 6907
H x B (mm)	121 x 45	128 x 71
2500 mm	<input type="checkbox"/>	<input type="checkbox"/>
5000 mm	<input type="checkbox"/>	<input type="checkbox"/>

13

Specification

Quantity



<p>W: _____ °</p> <p>H: _____ mm</p> <p>L1: _____ mm</p> <p>L2: _____ mm</p>	<p>_____ pc.</p>		
--	------------------	--	----------

14

Specification

Quantity



<p>W: _____ °</p> <p>H: _____ mm</p> <p>L1: _____ mm</p> <p>L2: _____ mm</p>	<p>_____ pc.</p>		
--	------------------	--	----------



Sender

Name

Telephone

Company

Telefax

Street, house no.

E-mail

Postcode, city, country

Customer number



CUSTOM TUBE BENDING SERVICE

Convenient, accurate and made to measure

Are you looking for tube bending in 2D or 3D? Then take advantage of Q-railing's custom tube bending service and leave the bending to us! Just tell us the sizes and bending radii, and we'll provide the pre-fabricated solution for your project. You'll save time, avoid the need for expensive machinery, and get your bent tubes with absolutely no risk.

For a perfect result, all you need to do is supply your details.

All bending work will be executed with the upmost care, based on the information you provide. Please use the order form to clearly inform us of your specifications, as we do not measure on-site.

Carefully check our pre-bend drawings

Based on the information you provide, we'll produce drawings of the bent products to be manufactured. Please check these carefully before signing-off on the release form. After we have received your approval we will immediately manufacture to your order specifications.

Cost-effective 2D bends

All 2D bent products arrive 100% ready for mounting - cut to length, shaped to your requirements and specially treated. Due to the bending production process, it is necessary to manufacture a longer tube. All waste sections and cut offs will be delivered together with the 2D bended tube. Otherwise, there's no need for extra effort or labour because as soon as you receive your order, it's ready for installation with a perfect finish.

Our approach to 3D bends

With all 3D bending work we assume a linear gradient and a constant radius. To make it easy for you to carry out any adjustments for construction tolerances on site, your tubes will be delivered with the waste sections still attached. We'll apply cutting marks on the tube for the actual usable length, ready for you to make the cuts during installation. With cap-rails, please note that the glass itself, as well as its installation, is subject to tolerances. Always choose a glass tube combination that makes a minimum of 5 mm tolerance possible.

The tubes themselves are treated by us after bending. This ensures you have a perfect surface and smooth installation without additional effort.

Transport and packaging

We properly package all bent products and supply them in good order for transportation. We recommend that you keep your tubes packaged until installation to prevent any change in shape, damage, or accidental marking.

Products are secured by suitable packaging aids to provide stabilisation and protection. This prevents any deformation during transport or pre-installation storage.



BENDING 2D & 3D

(round tube)

Service

Enquiry form

All 2D bent products arrive 100% ready for mounting - cut to length, shaped to your requirements and specially treated.

		2500 mm	5000 mm	304 Satin	316 Satin	304 Polished	316 Polished	R _{min.} (2D)	R _{min.} (3D)
●	∅ 10 mm	<input type="checkbox"/>	<input type="checkbox"/>	<input type="checkbox"/>				250 mm	250 mm
●	∅ 12 mm	<input type="checkbox"/>	<input type="checkbox"/>	<input type="checkbox"/>	<input type="checkbox"/>	<input type="checkbox"/>	<input type="checkbox"/>	250 mm	250 mm
●	∅ 14 mm	<input type="checkbox"/>	<input type="checkbox"/>	<input type="checkbox"/>				250 mm	250 mm
○	∅ 16 x 1,0 mm	<input type="checkbox"/>	<input type="checkbox"/>	<input type="checkbox"/>	<input type="checkbox"/>			500 mm	500 mm
○	∅ 33,7 x 2,0 mm	<input type="checkbox"/>	<input type="checkbox"/>	<input type="checkbox"/>				500 mm	500 mm
○	∅ 42,4 x 2,0 mm	<input type="checkbox"/>	<input type="checkbox"/>	<input type="checkbox"/>	<input type="checkbox"/>	<input type="checkbox"/>	<input type="checkbox"/>	500 mm	500 mm
○	∅ 42,4 x 2,6 mm	<input type="checkbox"/>	<input type="checkbox"/>	<input type="checkbox"/>	<input type="checkbox"/>			1000 mm	1000 mm
○	∅ 48,3 x 2,0 mm	<input type="checkbox"/>	<input type="checkbox"/>	<input type="checkbox"/>	<input type="checkbox"/>			500 mm	500 mm
○	∅ 48,3 x 2,6 mm	<input type="checkbox"/>	<input type="checkbox"/>	<input type="checkbox"/>	<input type="checkbox"/>	<input type="checkbox"/>	<input type="checkbox"/>	1000 mm	1000 mm
○	∅ 60,3 x 2,0 mm	<input type="checkbox"/>	<input type="checkbox"/>	<input type="checkbox"/>				1000 mm	1000 mm
□	40 x 40 x 2,0 mm (2D)	<input type="checkbox"/>	<input type="checkbox"/>	<input type="checkbox"/>	<input type="checkbox"/>			3500 mm	
Quantity:									

2D

R = _____ mm
W = _____ °

3D

Effective length of tube with 3D bending is a maximum 3500 mm.
With all 3D bending work we assume a linear gradient and a constant radius.

Stairs

D = _____ mm
W = _____ °

Left

Right

Handrail

H = _____ mm
H1 = _____ mm
Hp1 = _____ mm
Hp2 = _____ mm

D = _____ mm
W = _____ °



Sender

Name _____
Company _____
Street, house no. _____
Postcode, city, country _____

Telephone _____
Telefax _____
E-mail _____
Customer number _____



BENDING 2D

(round tube)

Service

Enquiry form

All 2D bent products arrive 100% ready for mounting - cut to length, shaped to your requirements and specially treated.

1 Specification

Quantity

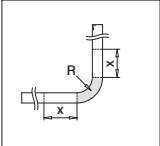
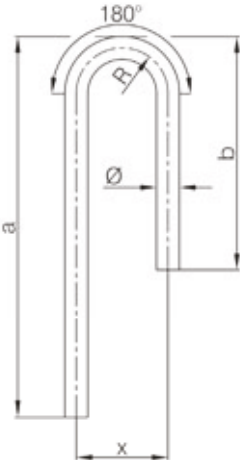
<input type="checkbox"/> <p>W: 180°</p> <p>a: _____ mm</p> <p>b: _____ mm</p>  <p>Xmin 120 mm</p>		Ø	R	X	304	316	
		Ø 33,7 x 2,0 mm	67 mm <input type="checkbox"/>	134 mm	<input type="checkbox"/>		
		Ø 42,4 x 2,0 mm	64 mm <input type="checkbox"/>	128 mm	<input type="checkbox"/>	<input type="checkbox"/>	
			85 mm <input type="checkbox"/>	170 mm	<input type="checkbox"/>		
		Ø 42,4 x 2,6 mm	64 mm <input type="checkbox"/>	128 mm	<input type="checkbox"/>	<input type="checkbox"/>	
			85 mm <input type="checkbox"/>	170 mm	<input type="checkbox"/>		
		Ø 48,3 x 2,0 mm	73 mm <input type="checkbox"/>	146 mm	<input type="checkbox"/>	<input type="checkbox"/>	
			97 mm <input type="checkbox"/>	154 mm	<input type="checkbox"/>		
Ø 48,3 x 2,6 mm	73 mm <input type="checkbox"/>	146 mm	<input type="checkbox"/>	<input type="checkbox"/>			
	97 mm <input type="checkbox"/>	154 mm	<input type="checkbox"/>				
Ø 60,3 x 2,0 mm	121 mm <input type="checkbox"/>	242 mm	<input type="checkbox"/>				

2 Specification

Quantity

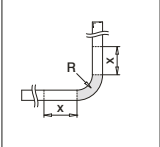
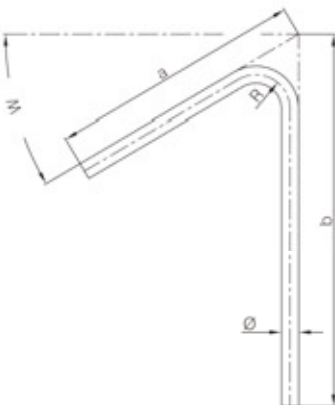
<input type="checkbox"/> <p>W: _____ °</p> <p>a: _____ mm</p> <p>b: _____ mm</p>  <p>Xmin 120 mm</p>		Ø	R	304	316		
		Ø 33,7 x 2,0 mm	67 mm <input type="checkbox"/>		<input type="checkbox"/>		
		Ø 42,4 x 2,0 mm	64 mm <input type="checkbox"/>	85 mm <input type="checkbox"/>	<input type="checkbox"/>	<input type="checkbox"/>	
			64 mm <input type="checkbox"/>	85 mm <input type="checkbox"/>	<input type="checkbox"/>		
		Ø 48,3 x 2,0 mm	73 mm <input type="checkbox"/>	97 mm <input type="checkbox"/>	<input type="checkbox"/>	<input type="checkbox"/>	
			73 mm <input type="checkbox"/>	97 mm <input type="checkbox"/>	<input type="checkbox"/>		
		Ø 60,3 x 2,0 mm	121 mm <input type="checkbox"/>		<input type="checkbox"/>		

Service

5



Sender

Name

Telephone

Company

Telefax

Street, house no.

E-mail

Postcode, city, country

Customer number



BENDING 2D

(round tube)

Service

Enquiry form

All 2D bent products arrive 100% ready for mounting - cut to length, shaped to your requirements and specially treated.

3 Specification

Quantity

W: _____ °

a: _____ mm

b: _____ mm

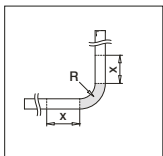

Xmin 120 mm

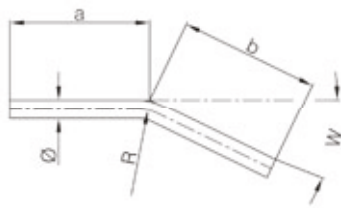

Ø	R	
Ø 33,7 x 2,0 mm	67 mm	<input type="checkbox"/>
Ø 42,4 x 2,0 mm	64 mm	85 mm
Ø 42,4 x 2,6 mm	64 mm	85 mm
Ø 48,3 x 2,0 mm	73 mm	97 mm
Ø 48,3 x 2,6 mm	73 mm	97 mm
Ø 60,3 x 2,0 mm	121 mm	<input type="checkbox"/>

304	316	
<input type="checkbox"/>	<input type="checkbox"/>	
<input type="checkbox"/>	<input type="checkbox"/>	
<input type="checkbox"/>	<input type="checkbox"/>	
<input type="checkbox"/>	<input type="checkbox"/>	
<input type="checkbox"/>	<input type="checkbox"/>	
<input type="checkbox"/>	<input type="checkbox"/>	

4a Specification

Quantity

W: _____ °

a: _____ mm

b: _____ mm

c: _____ mm

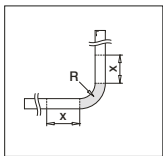

Xmin 120 mm

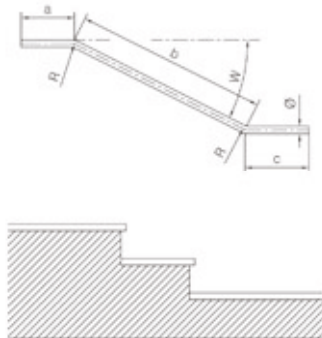

Ø	R	
Ø 33,7 x 2,0 mm	67 mm	<input type="checkbox"/>
Ø 42,4 x 2,0 mm	64 mm	85 mm
Ø 42,4 x 2,6 mm	64 mm	85 mm
Ø 48,3 x 2,0 mm	73 mm	97 mm
Ø 48,3 x 2,6 mm	73 mm	97 mm
Ø 60,3 x 2,0 mm	121 mm	<input type="checkbox"/>

304	316	
<input type="checkbox"/>	<input type="checkbox"/>	
<input type="checkbox"/>	<input type="checkbox"/>	
<input type="checkbox"/>	<input type="checkbox"/>	
<input type="checkbox"/>	<input type="checkbox"/>	
<input type="checkbox"/>	<input type="checkbox"/>	
<input type="checkbox"/>	<input type="checkbox"/>	



Sender

Name _____

Telephone _____

Company _____

Telefax _____

Street, house no. _____

E-mail _____

Postcode, city, country _____

Customer number _____



BENDING 2D

(round tube)

Service

Enquiry form

All 2D bent products arrive 100% ready for mounting - cut to length, shaped to your requirements and specially treated.

4b Specification

Quantity



W: _____ °

a: _____ mm

b: _____ mm

c: _____ mm

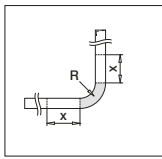

Xmin 120 mm

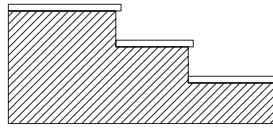
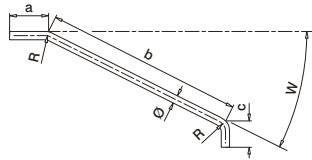

Ø	R	
Ø 33,7 x 2,0 mm	67 mm	<input type="checkbox"/>
Ø 42,4 x 2,0 mm	64 mm	85 mm
Ø 42,4 x 2,6 mm	64 mm	85 mm
Ø 48,3 x 2,0 mm	73 mm	97 mm
Ø 48,3 x 2,6 mm	73 mm	97 mm
Ø 60,3 x 2,0 mm	121 mm	<input type="checkbox"/>

304	316	
<input type="checkbox"/>		
<input type="checkbox"/>	<input type="checkbox"/>	
<input type="checkbox"/>	<input type="checkbox"/>	
<input type="checkbox"/>	<input type="checkbox"/>	
<input type="checkbox"/>	<input type="checkbox"/>	
<input type="checkbox"/>		

Sender

Name

Telephone

Company

Telefax

Street, house no.

E-mail

Postcode, city, country

Customer number



BENDING 2D

(round tube)

Service

Enquiry form

All 2D bent products arrive 100% ready for mounting - cut to length, shaped to your requirements and specially treated.

5 Specification

Quantity

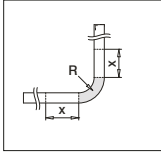
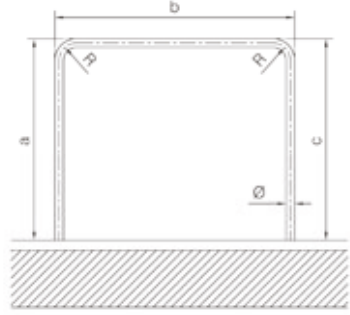
<input type="checkbox"/> <p>a: _____ mm</p> <p>b: _____ mm</p> <p>c: _____ mm</p>  <p>X_{min} 120 mm</p>		Ø	R	304	316		
		Ø 33,7 x 2,0 mm	67 mm		<input type="checkbox"/>		
		Ø 42,4 x 2,0 mm	64 mm	85 mm	<input type="checkbox"/>	<input type="checkbox"/>	
		Ø 42,4 x 2,6 mm	64 mm	85 mm	<input type="checkbox"/>	<input type="checkbox"/>	
		Ø 48,3 x 2,0 mm	73 mm	97 mm	<input type="checkbox"/>	<input type="checkbox"/>	
		Ø 48,3 x 2,6 mm	73 mm	97 mm	<input type="checkbox"/>	<input type="checkbox"/>	
		Ø 60,3 x 2,0 mm	121 mm		<input type="checkbox"/>		

6 Specification

Quantity

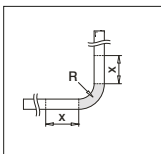
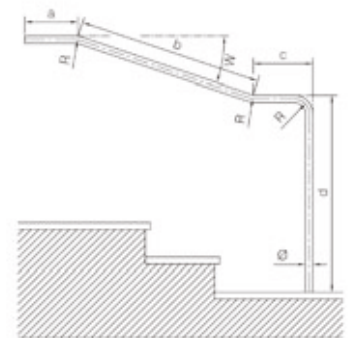
<input type="checkbox"/> <p>W: _____ °</p> <p>a: _____ mm</p> <p>b: _____ mm</p> <p>c: _____ mm</p> <p>d: _____ mm</p>  <p>X_{min} 120 mm</p>		Ø	R	304	316		
		Ø 33,7 x 2,0 mm	67 mm		<input type="checkbox"/>		
		Ø 42,4 x 2,0 mm	64 mm	85 mm	<input type="checkbox"/>	<input type="checkbox"/>	
		Ø 42,4 x 2,6 mm	64 mm	85 mm	<input type="checkbox"/>	<input type="checkbox"/>	
		Ø 48,3 x 2,0 mm	73 mm	97 mm	<input type="checkbox"/>	<input type="checkbox"/>	
		Ø 48,3 x 2,6 mm	73 mm	97 mm	<input type="checkbox"/>	<input type="checkbox"/>	
		Ø 60,3 x 2,0 mm	121 mm		<input type="checkbox"/>		



Sender

Name

Telephone

Company

Telefax

Street, house no.

E-mail

Postcode, city, country

Customer number

5

Service



BENDING 2D

(round tube)

Service

Enquiry form

All 2D bent products arrive 100% ready for mounting - cut to length, shaped to your requirements and specially treated.

7 Specification

Quantity

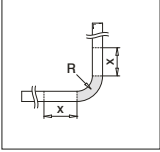
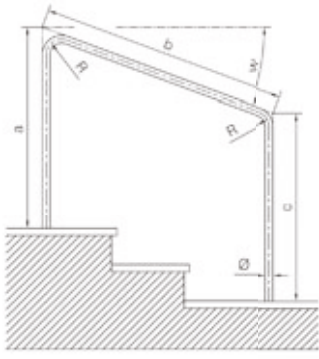
<input type="checkbox"/> <p>W: _____ °</p> <p>a: _____ mm</p> <p>b: _____ mm</p> <p>c: _____ mm</p>  <p>X_{min} 120 mm</p>		Ø	R	304	316	
		Ø 33,7 x 2,0 mm	67 mm <input type="checkbox"/>		<input type="checkbox"/>	
		Ø 42,4 x 2,0 mm	64 mm <input type="checkbox"/>	85 mm <input type="checkbox"/>	<input type="checkbox"/>	<input type="checkbox"/>
		Ø 42,4 x 2,6 mm	64 mm <input type="checkbox"/>	85 mm <input type="checkbox"/>	<input type="checkbox"/>	<input type="checkbox"/>
		Ø 48,3 x 2,0 mm	73 mm <input type="checkbox"/>	97 mm <input type="checkbox"/>	<input type="checkbox"/>	<input type="checkbox"/>
		Ø 48,3 x 2,6 mm	73 mm <input type="checkbox"/>	97 mm <input type="checkbox"/>	<input type="checkbox"/>	<input type="checkbox"/>
		Ø 60,3 x 2,0 mm	121 mm <input type="checkbox"/>		<input type="checkbox"/>	

8 Specification

Quantity

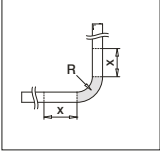
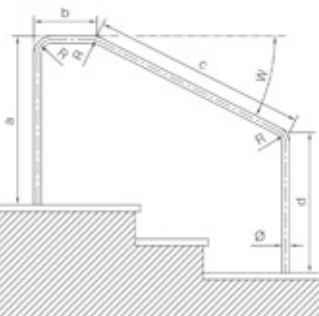
<input type="checkbox"/> <p>W: _____ °</p> <p>a: _____ mm</p> <p>b: _____ mm</p> <p>c: _____ mm</p> <p>d: _____ mm</p>  <p>X_{min} 120 mm</p>		Ø	R	304	316	
		Ø 33,7 x 2,0 mm	67 mm <input type="checkbox"/>		<input type="checkbox"/>	
		Ø 42,4 x 2,0 mm	64 mm <input type="checkbox"/>	85 mm <input type="checkbox"/>	<input type="checkbox"/>	<input type="checkbox"/>
		Ø 42,4 x 2,6 mm	64 mm <input type="checkbox"/>	85 mm <input type="checkbox"/>	<input type="checkbox"/>	<input type="checkbox"/>
		Ø 48,3 x 2,0 mm	73 mm <input type="checkbox"/>	97 mm <input type="checkbox"/>	<input type="checkbox"/>	<input type="checkbox"/>
		Ø 48,3 x 2,6 mm	73 mm <input type="checkbox"/>	97 mm <input type="checkbox"/>	<input type="checkbox"/>	<input type="checkbox"/>
		Ø 60,3 x 2,0 mm	121 mm <input type="checkbox"/>		<input type="checkbox"/>	

Service

5



Sender

Name

Telephone

Company

Telefax

Street, house no.

E-mail

Postcode, city, country

Customer number



BENDING 2D

(round tube)

Service

Enquiry form

All 2D bent products arrive 100% ready for mounting - cut to length, shaped to your requirements and specially treated.

9 Specification

Quantity

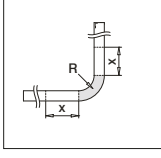
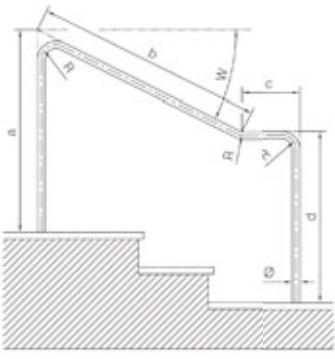
<input type="checkbox"/> <p>W: _____ °</p> <p>a: _____ mm</p> <p>b: _____ mm</p> <p>c: _____ mm</p> <p>d: _____ mm</p>  <p>Xmin 120 mm</p>		Ø	R	304	316		
		Ø 33,7 x 2,0 mm	67 mm <input type="checkbox"/>		<input type="checkbox"/>		
		Ø 42,4 x 2,0 mm	64 mm <input type="checkbox"/>	85 mm <input type="checkbox"/>	<input type="checkbox"/>	<input type="checkbox"/>	
		Ø 42,4 x 2,6 mm	64 mm <input type="checkbox"/>	85 mm <input type="checkbox"/>	<input type="checkbox"/>	<input type="checkbox"/>	
		Ø 48,3 x 2,0 mm	73 mm <input type="checkbox"/>	97 mm <input type="checkbox"/>	<input type="checkbox"/>	<input type="checkbox"/>	
		Ø 48,3 x 2,6 mm	73 mm <input type="checkbox"/>	97 mm <input type="checkbox"/>	<input type="checkbox"/>	<input type="checkbox"/>	
		Ø 60,3 x 2,0 mm	121 mm <input type="checkbox"/>		<input type="checkbox"/>		

10 Specification

Quantity

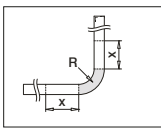
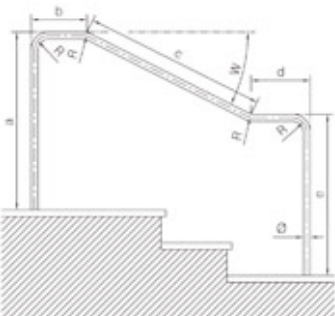
<input type="checkbox"/> <p>W: _____ °</p> <p>a: _____ mm</p> <p>b: _____ mm</p> <p>c: _____ mm</p> <p>d: _____ mm</p> <p>e: _____ mm</p>  <p>Xmin 120 mm</p>		Ø	R	304	316		
		Ø 33,7 x 2,0 mm	67 mm <input type="checkbox"/>		<input type="checkbox"/>		
		Ø 42,4 x 2,0 mm	64 mm <input type="checkbox"/>	85 mm <input type="checkbox"/>	<input type="checkbox"/>	<input type="checkbox"/>	
		Ø 42,4 x 2,6 mm	64 mm <input type="checkbox"/>	85 mm <input type="checkbox"/>	<input type="checkbox"/>	<input type="checkbox"/>	
		Ø 48,3 x 2,0 mm	73 mm <input type="checkbox"/>	97 mm <input type="checkbox"/>	<input type="checkbox"/>	<input type="checkbox"/>	
		Ø 48,3 x 2,6 mm	73 mm <input type="checkbox"/>	97 mm <input type="checkbox"/>	<input type="checkbox"/>	<input type="checkbox"/>	
		Ø 60,3 x 2,0 mm	121 mm <input type="checkbox"/>		<input type="checkbox"/>		



Sender

Name

Telephone

Company

Telefax

Street, house no.

E-mail

Postcode, city, country

Customer number



BENDING 2D

(round tube)

Service

Enquiry form

All 2D bent products arrive 100% ready for mounting - cut to length, shaped to your requirements and specially treated.

11

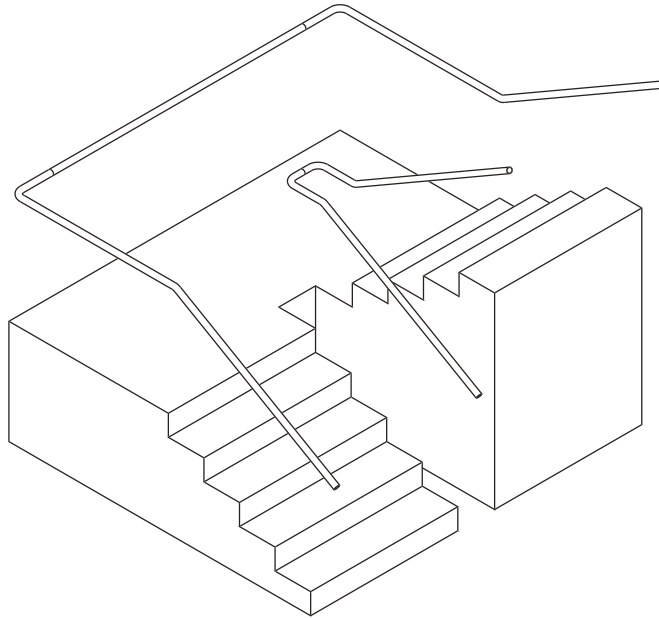

11a Specification

Quantity



W1: _____ °

W2: _____ °

a: _____ mm

b: _____ mm

c: _____ mm

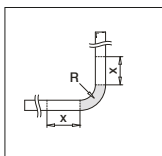

Xmin 120 mm

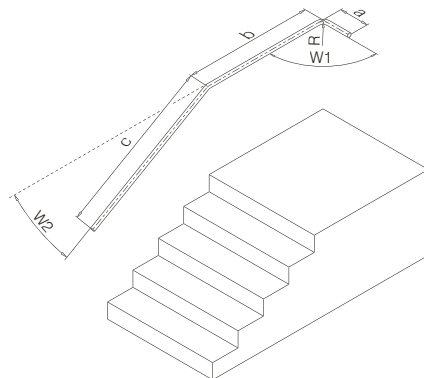

Ø	R	
Ø 33,7 x 2,0 mm	67 mm	<input type="checkbox"/>
Ø 42,4 x 2,0 mm	64 mm	85 mm
Ø 42,4 x 2,6 mm	64 mm	85 mm
Ø 48,3 x 2,0 mm	73 mm	97 mm
Ø 48,3 x 2,6 mm	73 mm	97 mm
Ø 60,3 x 2,0 mm	121 mm	<input type="checkbox"/>

		304	316	
<input type="checkbox"/>		<input type="checkbox"/>	<input type="checkbox"/>	
<input type="checkbox"/>		<input type="checkbox"/>	<input type="checkbox"/>	
<input type="checkbox"/>		<input type="checkbox"/>	<input type="checkbox"/>	
<input type="checkbox"/>		<input type="checkbox"/>	<input type="checkbox"/>	
<input type="checkbox"/>		<input type="checkbox"/>	<input type="checkbox"/>	

Service

5



Sender

Name

Telephone

Company

Telefax

Street, house no.

E-mail

Postcode, city, country

Customer number



BENDING 2D

(round tube)

Service

Enquiry form

All 2D bent products arrive 100% ready for mounting - cut to length, shaped to your requirements and specially treated.

11b Specification

Quantity

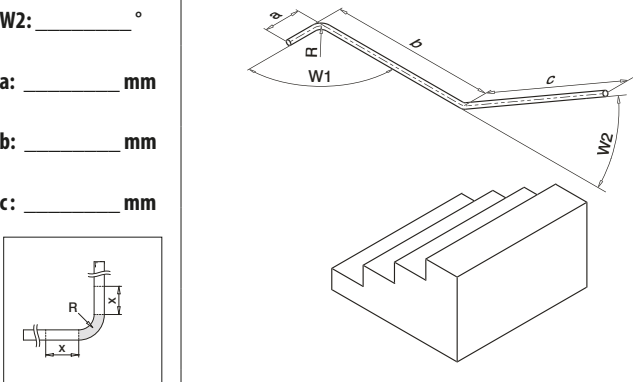
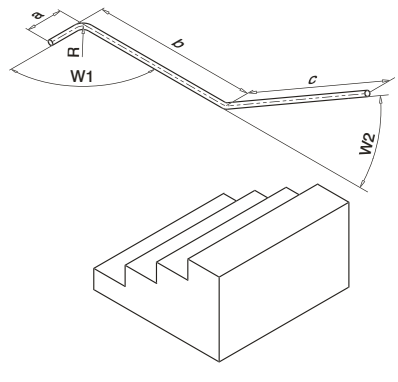
<input type="checkbox"/> <p>W1: _____ °</p> <p>W2: _____ °</p> <p>a: _____ mm</p> <p>b: _____ mm</p> <p>c: _____ mm</p>  <p>Xmin 120 mm</p>		∅	R	304	316	
		∅ 33,7 x 2,0 mm	67 mm	<input type="checkbox"/>	<input type="checkbox"/>	<input type="checkbox"/>
		∅ 42,4 x 2,0 mm	64 mm 85 mm	<input type="checkbox"/>	<input type="checkbox"/>	<input type="checkbox"/>
		∅ 42,4 x 2,6 mm	64 mm 85 mm	<input type="checkbox"/>	<input type="checkbox"/>	<input type="checkbox"/>
		∅ 48,3 x 2,0 mm	73 mm 97 mm	<input type="checkbox"/>	<input type="checkbox"/>	<input type="checkbox"/>
		∅ 48,3 x 2,6 mm	73 mm 97 mm	<input type="checkbox"/>	<input type="checkbox"/>	<input type="checkbox"/>
		∅ 60,3 x 2,0 mm	121 mm	<input type="checkbox"/>	<input type="checkbox"/>	<input type="checkbox"/>

11c Specification

Quantity

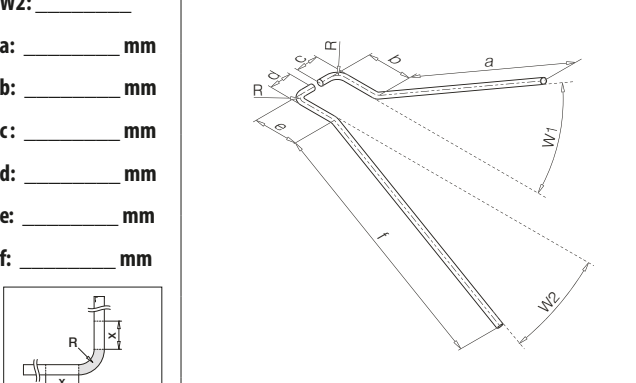
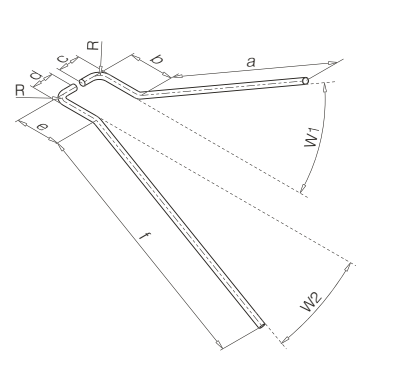
<input type="checkbox"/> <p>W1: _____ °</p> <p>W2: _____ °</p> <p>a: _____ mm</p> <p>b: _____ mm</p> <p>c: _____ mm</p> <p>d: _____ mm</p> <p>e: _____ mm</p> <p>f: _____ mm</p>  <p>Xmin 120 mm</p>		∅	R	304	316	
		∅ 33,7 x 2,0 mm	67 mm	<input type="checkbox"/>	<input type="checkbox"/>	<input type="checkbox"/>
		∅ 42,4 x 2,0 mm	64 mm 85 mm	<input type="checkbox"/>	<input type="checkbox"/>	<input type="checkbox"/>
		∅ 42,4 x 2,6 mm	64 mm 85 mm	<input type="checkbox"/>	<input type="checkbox"/>	<input type="checkbox"/>
		∅ 48,3 x 2,0 mm	73 mm 97 mm	<input type="checkbox"/>	<input type="checkbox"/>	<input type="checkbox"/>
		∅ 48,3 x 2,6 mm	73 mm 97 mm	<input type="checkbox"/>	<input type="checkbox"/>	<input type="checkbox"/>
		∅ 60,3 x 2,0 mm	121 mm	<input type="checkbox"/>	<input type="checkbox"/>	<input type="checkbox"/>



Sender

Name _____

Telephone _____

Company _____

Telefax _____

Street, house no. _____

E-mail _____

Postcode, city, country _____

Customer number _____



BENDING 2D

(round tube)

Service

Enquiry form

All 2D bent products arrive 100% ready for mounting - cut to length, shaped to your requirements and specially treated.

12

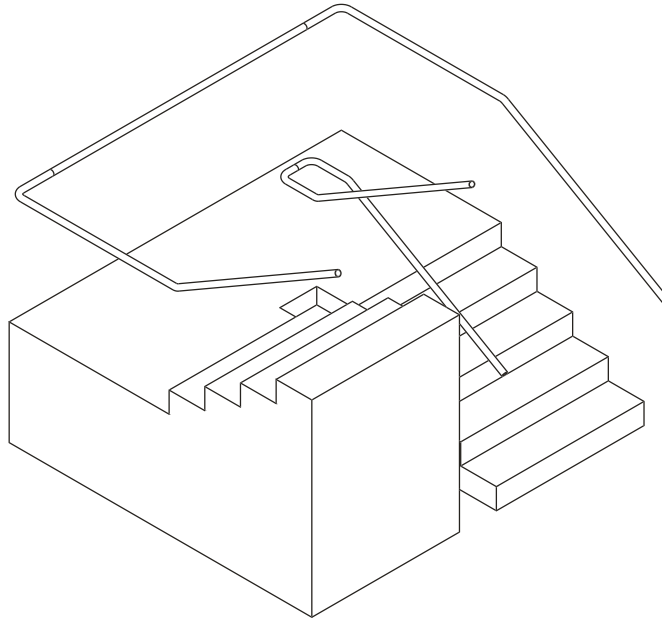

12a Specification

Quantity



W1: _____ °

W2: _____ °

a: _____ mm

b: _____ mm

c: _____ mm

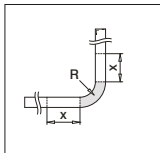

Xmin 120 mm

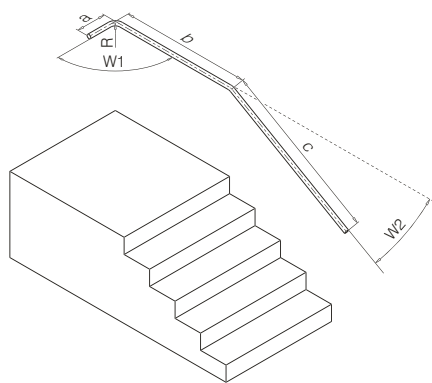

Ø	R	
Ø 33,7 x 2,0 mm	67 mm	<input type="checkbox"/>
Ø 42,4 x 2,0 mm	64 mm	85 mm
Ø 42,4 x 2,6 mm	64 mm	85 mm
Ø 48,3 x 2,0 mm	73 mm	97 mm
Ø 48,3 x 2,6 mm	73 mm	97 mm
Ø 60,3 x 2,0 mm	121 mm	<input type="checkbox"/>

		304	316	
<input type="checkbox"/>		<input type="checkbox"/>	<input type="checkbox"/>	
<input type="checkbox"/>		<input type="checkbox"/>	<input type="checkbox"/>	
<input type="checkbox"/>		<input type="checkbox"/>	<input type="checkbox"/>	
<input type="checkbox"/>		<input type="checkbox"/>	<input type="checkbox"/>	
<input type="checkbox"/>		<input type="checkbox"/>	<input type="checkbox"/>	

Service

5



Sender

Name

Telephone

Company

Telefax

Street, house no.

E-mail

Postcode, city, country

Customer number



BENDING 2D

(round tube)

Service

Enquiry form

All 2D bent products arrive 100% ready for mounting - cut to length, shaped to your requirements and specially treated.

12b Specification

Quantity

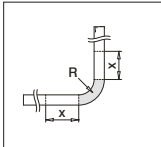
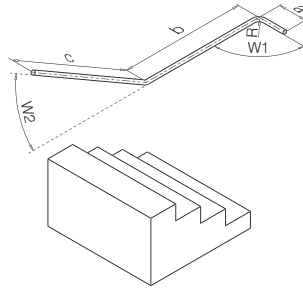
<input type="checkbox"/> <p>W1: _____ °</p> <p>W2: _____ °</p> <p>a: _____ mm</p> <p>b: _____ mm</p> <p>c: _____ mm</p>  <p>X_{min} 120 mm</p>		∅	R	304	316		
		∅ 33,7 x 2,0 mm	67 mm	<input type="checkbox"/>	<input type="checkbox"/>	<input type="checkbox"/>	<input type="checkbox"/>
		∅ 42,4 x 2,0 mm	64 mm 85 mm	<input type="checkbox"/>	<input type="checkbox"/>	<input type="checkbox"/>	<input type="checkbox"/>
		∅ 42,4 x 2,6 mm	64 mm 85 mm	<input type="checkbox"/>	<input type="checkbox"/>	<input type="checkbox"/>	<input type="checkbox"/>
		∅ 48,3 x 2,0 mm	73 mm 97 mm	<input type="checkbox"/>	<input type="checkbox"/>	<input type="checkbox"/>	<input type="checkbox"/>
		∅ 48,3 x 2,6 mm	73 mm 97 mm	<input type="checkbox"/>	<input type="checkbox"/>	<input type="checkbox"/>	<input type="checkbox"/>
		∅ 60,3 x 2,0 mm	121 mm	<input type="checkbox"/>	<input type="checkbox"/>	<input type="checkbox"/>	<input type="checkbox"/>

12c Specification

Quantity

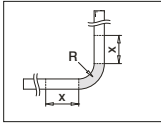
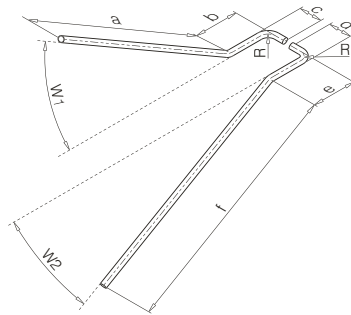
<input type="checkbox"/> <p>W1: _____ °</p> <p>W2: _____ °</p> <p>a: _____ mm</p> <p>b: _____ mm</p> <p>c: _____ mm</p> <p>d: _____ mm</p> <p>e: _____ mm</p> <p>f: _____ mm</p>  <p>X_{min} 120 mm</p>		∅	R	304	316		
		∅ 33,7 x 2,0 mm	67 mm	<input type="checkbox"/>	<input type="checkbox"/>	<input type="checkbox"/>	<input type="checkbox"/>
		∅ 42,4 x 2,0 mm	64 mm 85 mm	<input type="checkbox"/>	<input type="checkbox"/>	<input type="checkbox"/>	<input type="checkbox"/>
		∅ 42,4 x 2,6 mm	64 mm 85 mm	<input type="checkbox"/>	<input type="checkbox"/>	<input type="checkbox"/>	<input type="checkbox"/>
		∅ 48,3 x 2,0 mm	73 mm 97 mm	<input type="checkbox"/>	<input type="checkbox"/>	<input type="checkbox"/>	<input type="checkbox"/>
		∅ 48,3 x 2,6 mm	73 mm 97 mm	<input type="checkbox"/>	<input type="checkbox"/>	<input type="checkbox"/>	<input type="checkbox"/>
		∅ 60,3 x 2,0 mm	121 mm	<input type="checkbox"/>	<input type="checkbox"/>	<input type="checkbox"/>	<input type="checkbox"/>



Sender

Name

Telephone

Company

Telefax

Street, house no.

E-mail

Postcode, city, country

Customer number



BENDING 2D

(round tube)

Service

Enquiry form

All 2D bent products arrive 100% ready for mounting - cut to length, shaped to your requirements and specially treated.

13 Specification

Quantity

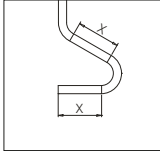
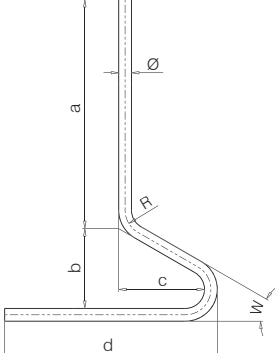
<input type="checkbox"/> <p>W: _____ °</p> <p>a: _____ mm</p> <p>b: _____ mm</p> <p>c: _____ mm</p> <p>d: _____ mm</p>  <p>Xmin 120 mm</p>		<p>Ø</p> <p>R</p>	<p>304</p> <p>316</p>		
		<p>Ø 42,4 x 2,0 mm</p> <p>64 mm</p> <p>85 mm</p>	<input type="checkbox"/>	<input type="checkbox"/>	
		<p>Ø 42,4 x 2,6 mm</p> <p>64 mm</p> <p>85 mm</p>	<input type="checkbox"/>	<input type="checkbox"/>	
		<p>Ø 48,3 x 2,0 mm</p> <p>73 mm</p> <p>97 mm</p>	<input type="checkbox"/>	<input type="checkbox"/>	
		<p>Ø 48,3 x 2,6 mm</p> <p>73 mm</p> <p>97 mm</p>	<input type="checkbox"/>	<input type="checkbox"/>	

14a Specification

Quantity

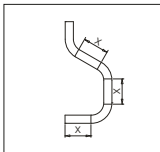
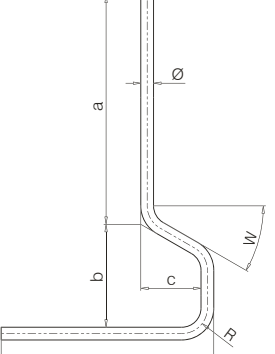
<input type="checkbox"/> <p>W: _____ °</p> <p>a: _____ mm</p> <p>b: _____ mm</p> <p>c: _____ mm</p> <p>d: _____ mm</p>  <p>Xmin 120 mm</p>		<p>Ø</p> <p>R</p>	<p>304</p> <p>316</p>		
		<p>Ø 42,4 x 2,0 mm</p> <p>64 mm</p> <p>85 mm</p>	<input type="checkbox"/>	<input type="checkbox"/>	
		<p>Ø 42,4 x 2,6 mm</p> <p>64 mm</p> <p>85 mm</p>	<input type="checkbox"/>	<input type="checkbox"/>	
		<p>Ø 48,3 x 2,0 mm</p> <p>73 mm</p> <p>97 mm</p>	<input type="checkbox"/>	<input type="checkbox"/>	
		<p>Ø 48,3 x 2,6 mm</p> <p>73 mm</p> <p>97 mm</p>	<input type="checkbox"/>	<input type="checkbox"/>	

Service

5



Sender

Name

Telephone

Company

Telefax

Street, house no.

E-mail

Postcode, city, country

Customer number



DRILLING

(round tube)

Service

Enquiry form

All 2D bent products arrive 100% ready for mounting - cut to length, shaped to your requirements and specially treated.

14b Specification



H1: _____ mm

H2: _____ mm

H3: _____ mm

H4: _____ mm

ØB: _____ mm

W: _____ °

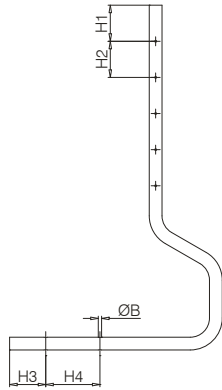

Type

Quantity

Quantity

Threading

H1/H2	
<input type="checkbox"/>	
<input type="checkbox"/>	
<input type="checkbox"/>	
<input type="checkbox"/>	
<input type="checkbox"/>	
<input type="checkbox"/>	
<input type="checkbox"/>	

Tube	Drilling holes	Ø mm	M6	M8	M10
			<input type="checkbox"/>	<input type="checkbox"/>	<input type="checkbox"/>
			<input type="checkbox"/>	<input type="checkbox"/>	<input type="checkbox"/>
			<input type="checkbox"/>	<input type="checkbox"/>	<input type="checkbox"/>
			<input type="checkbox"/>	<input type="checkbox"/>	<input type="checkbox"/>
			<input type="checkbox"/>	<input type="checkbox"/>	<input type="checkbox"/>
			<input type="checkbox"/>	<input type="checkbox"/>	<input type="checkbox"/>
			<input type="checkbox"/>	<input type="checkbox"/>	<input type="checkbox"/>



Sender

Name

Telephone

Company

Telefax

Street, house no.

E-mail

Postcode, city, country

Customer number



BENDING 2D

Base shoes, top mount

Service
Enquiry form

All 2D bent products arrive 100% ready for mounting – cut to length, shaped to your requirements. Please bear in mind that the bending process will have an effect on the surface of the base shoe.

1 Specification Easy Glass® Slim

Quantity

<input type="checkbox"/> 16.6904.500.18 (121 x 45 mm)		R_{min} = 2000 mm	R_{min} = 2000 mm
		R = _____ mm W = _____ °	R = _____ mm W = _____ °
		<input type="checkbox"/> Base shoe (inside bend)	<input type="checkbox"/> Base shoe (outside bend)
Effective length of base shoe with 2D bending is a maximum 4000 mm. With all 2D bending work we assume a constant radius. Please consider ordering glass once the base shoe is installed, to guarantee the dimensions are correct.			

Service
5



Sender

Name _____	Telephone _____
Company _____	Telefax _____
Street, house no. _____	E-mail _____
Postcode, city, country _____	Customer number _____



BENDING 2D

Service
Enquiry form

Base shoes, top mount and fascia mount

All 2D bent products arrive 100% ready for mounting – cut to length, shaped to your requirements. Please bear in mind that the bending process will have an effect on the surface of the base shoe.

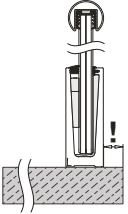
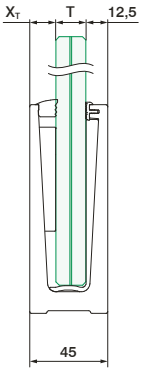
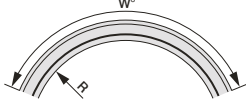
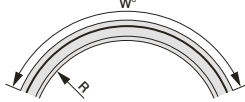
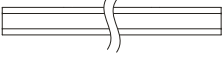
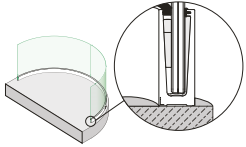
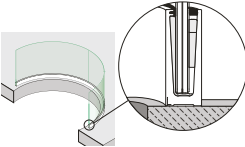

2a Specification Easy Glass® Slim

Quantity

<input type="checkbox"/>	16.6914.500.00 (121 x 45 mm) Without holes	R_{min} = 500 mm	R_{min} = 900 mm	
				
		R = _____ mm W = _____ °	R = _____ mm W = _____ °	
				
		<input type="checkbox"/> Base shoe (inside bend)	<input type="checkbox"/> Base shoe (outside bend)	
Effective length of base shoe with 2D bending is a maximum 4000 mm. With all 2D bending work we assume a constant radius. Please consider ordering glass once the base shoe is installed, to guarantee the dimensions are correct.				

2b Specification Easy Glass® Slim

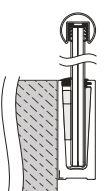
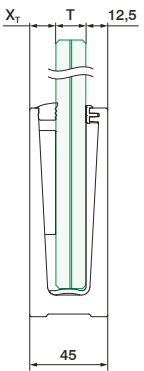
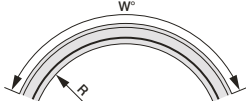
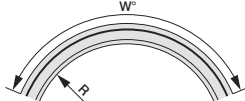
Quantity

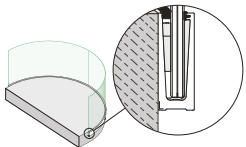
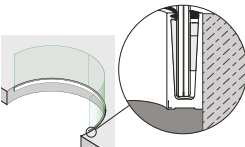
<input type="checkbox"/>	16.6914.500.00 (121 x 45 mm) Without holes	R_{min} = 500 mm	R_{min} = 900 mm	
				
		R = _____ mm W = _____ °	R = _____ mm W = _____ °	
				
		<input type="checkbox"/> Base shoe (inside bend)	<input type="checkbox"/> Base shoe (outside bend)	
Effective length of base shoe with 2D bending is a maximum 4000 mm. With all 2D bending work we assume a constant radius. Please consider ordering glass once the base shoe is installed, to guarantee the dimensions are correct.				



Sender

Name

Telephone

Company

Telefax

Street, house no.

E-mail

Postcode, city, country

Customer number











BENDING 2D

(cap rails)

Service

Enquiry form

All 2D bent products arrive 100% ready for mounting - cut to length, shaped to your requirements and specially treated.

		304 Satin	316 Satin	304 Polished	316 Polished	R _{min.} (2D)*				
	Ø 42,4 x 1,5 mm	<input type="checkbox"/>	<input type="checkbox"/>	<input type="checkbox"/>	<input type="checkbox"/>	1000 mm	<input type="checkbox"/>	<input type="checkbox"/>	<input type="checkbox"/>	<input type="checkbox"/>
	Ø 48,3 x 1,5 mm	<input type="checkbox"/>	<input type="checkbox"/>	<input type="checkbox"/>	<input type="checkbox"/>	1000 mm	<input type="checkbox"/>	<input type="checkbox"/>	<input type="checkbox"/>	<input type="checkbox"/>
	Ø 60,3 x 1,5 mm	<input type="checkbox"/>	<input type="checkbox"/>			2000 mm	<input type="checkbox"/>	<input type="checkbox"/>	<input type="checkbox"/>	<input type="checkbox"/>
	80 x 40 x 1,5 mm	<input type="checkbox"/>				750 mm	<input type="checkbox"/>		<input type="checkbox"/>	
	40 x 40 x 1,5 mm	<input type="checkbox"/>	<input type="checkbox"/>			3500 mm	<input type="checkbox"/>		<input type="checkbox"/>	
Quantity:						*Smaller radii are available only on request.				

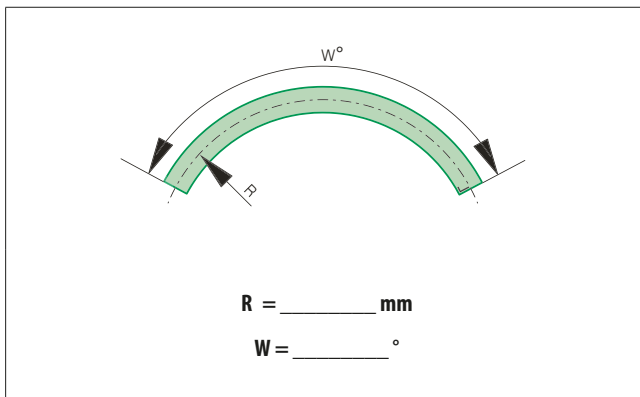

Sender

Name

Telephone

Company

Telefax

Street, house no.

E-mail

Postcode, city, country

Customer number



BENDING 3D

(cap rails, round)

Service

Enquiry form

3D Tubes will be delivered with the waste sections still attached. We will apply cutting marks on the tube for the actual usable length, and you will make the cuts during the installation process. With cap rails, please note that the glass itself, as well as its installation, is subject to tolerances. Always choose a glass tube combination that makes a minimum of 5 mm tolerance possible.

		304 Satin	316 Satin	304 Polished	316 Polished	R _{min.} (3D)*	T _{max.} (3D)
	Ø 42,4 x 1,5 mm	<input type="checkbox"/>	<input type="checkbox"/>	<input type="checkbox"/>	<input type="checkbox"/>	1000 mm	19 mm
	Ø 48,3 x 1,5 mm	<input type="checkbox"/>	<input type="checkbox"/>	<input type="checkbox"/>	<input type="checkbox"/>	1000 mm	19 mm
	Ø 60,3 x 1,5 mm	<input type="checkbox"/>	<input type="checkbox"/>			2000 mm	25,52 mm
Quantity:						*Smaller radii are available only on request.	

3D

Effective length of tube with 3D bending is a maximum 3500 mm.
With all 3D bending work we assume a linear gradient and a constant radius.

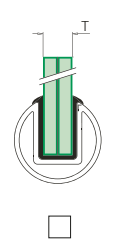

Left

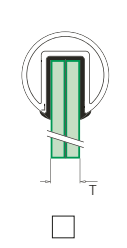

Right

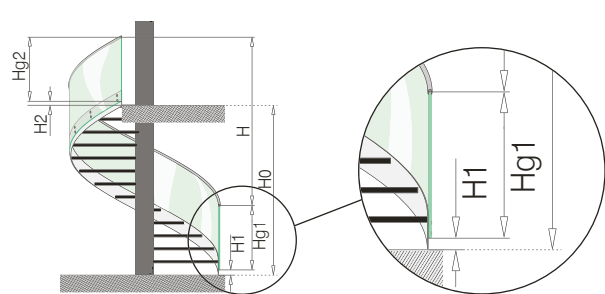

H = _____ mm H0 = _____ mm
 H1 = _____ mm H2 = _____ mm
 Hg1 = _____ mm Hg2 = _____ mm

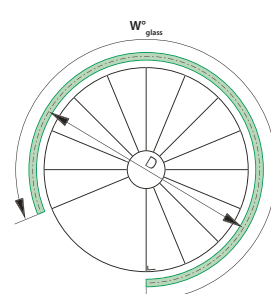

D = _____ mm
 W_{glass} = _____ °



Sender

Name _____

Company _____

Street, house no. _____

Postcode, city, country _____

Telephone _____

Telefax _____

E-mail _____

Customer number _____

KEY WORD INDEX

3

2D-bending	353 - 364, 366 - 368
3D-bending	353, 369
3kN	27 - 36

A

Abrasive pads	313
Accessories	22, 28 32, 61, 68, 107, 139, 163, 170, 235, 243, 246, 295 - 320
Adapter	37, 40 - 46, 62, 84, 95, 98, 99, 100, 114, 125, 147, 172 - 174, 190, 191, 218, 222, 239, 251, 280, 281, 282, 284, 285, 290 - 294
Adhesive tape, double-faced	312
Anchor	305 - 310

B

Baluster bracket	82, 93, 106, 107, 108, 123, 139, 140, 141, 213, 226, 227
Baluster posts	82, 92, 93, 102, 122, 129, 130 -198, 137, 212, 248
Baluster railing systems	73 - 252
Bar	87, 88, 91, 97, 98, 109, 150, 153 - 159, 217
Bar holder	87, 109, 155 - 158, 217
Bar holder, adjustable	154
Base flange	93, 104, 122, 134, 135, 226, 227, 248, 318
Base frame	317
Base profile	344 - 351, 366, 367
Beech	61, 68, 241, 243, 244
Bending	353 - 369
Bendywood	240 - 241
Blind plug	24, 34
Blind rivet nut	304
Bottom glass clamp	37 - 42
Brush	311

C

C-spanner	315
Cable	237
Cable cutter	163, 170, 315
Cable system	89, 161 - 167
Cable tie	305
Cap rail	55 - 72, 83 - 86, 145 - 148
Cedar	243
Circlip pliers	235, 315
Cladding	20, 24, 29, 33
Cleaner	313
Cleaning	313
Cleaning brush	311
Cleaning spray	313
Cleaning tissue	313
Connector	20, 24, 29, 32, 48, 56, 57, 60, 61, 64 65, 68, 71, 72, 86, 88, 115, 116, 120, 126, 146, 151, 200 - 204, 206, 207, 223, 224, 228, 239, 244, 245, 252
Connector, adjustable	56, 60, 64, 71, 86, 146, 203 - 207, 223, 239, 244, 246, 252
Connector, flexible	207
Connectors for baluster posts	114, 190, 191, 251
Consumable articles	311 - 313
Cover caps	92, 123, 142, 143, 176, 219, 248, 299
Crossbar holder	87, 109, 155 - 159, 217
Cutting	338 - 351
Cutting and drilling oil	314

D

Display	318, 319
Door lock	289
Drainage profile	21, 31
Drillhole cleaner	311
Drilling	314, 337, 338, 365
Drilling set	314
Drilling template	314

E

Easy Glass®	11-72
Easy Q-Web®	168 - 171
Electrical adapter plug	317
End fittings	21, 24, 25, 30, 33, 34, 57, 58, 60, 61, 62, 66, 67, 68, 72, 88, 117, 120, 122, 153, 239, 244, 246, 252
ESG (Toughened glass)	52, 85, 148

F

Fascia fix baluster bracket	82, 93, 105 - 108, 123, 138 - 141, 213, 226, 227
Fascia mount	22 - 26, 32 - 36, 41 - 50, 92, 93, 113, 123, 319
Fillings	39, 52, 83 - 89, 94 - 99, 109, 124, 145 - 174, 214 - 218, 249, 253 - 294
Fixing materials	301 - 310
Flow-drill set	314

G

Glass	52, 85, 148
Glass adapter	41, 42 - 50, 84, 290 - 294
Glass clamp	214 - 280, 249, 253 - 294
Glass clamping disc	95, 100, 282, 285
Glass cleaner	313
Glass cloths	313
Glass fitting aid	316
Glass Frame Tube	83 - 86, 145 - 148
Glass holders	95, 285
Glass infill holders	214 - 280, 249, 253 - 294
Glass railing systems	11-72
Glass suction lifter	316
Glue	312
Gripper for blind-rivet nut	315
Grub screw	304

H

Hammer	315
Handrail	53 - 72, 85, 86, 115, 119, 122, 125, 196 - 198, 242 - 246, 251
Handrail adapters	99, 114, 125, 190, 191, 222, 239, 251
Handrail bracket	90, 99, 110 - 113, 119, 125, 175 - 193, 219 - 221, 229 - 231, 238, 250
Handrail bracket parts	114, 192 - 195, 225 - 232
Handrail bracket, adjustable	90, 99, 111, 113, 177, 186, 189, 193
Hexagon screw	301, 303
Hexagon screw driver	315
Hinge	288

I

Infloor	38, 39, 92, 122, 123
Injection mortar	311

L

Laminated glass	52, 85, 148
LED-spotlights	233 - 239, 318
Leveling tool	317
Linear Line	91 - 100

M

Maintanance spray	313
Milling	314, 338
Mixer	311
Mounting block	26, 31, 35
Mounting profile	344 - 351, 366, 367
Mounting-plates	305

N

Nylon cover cap	299
-----------------	-----

O

Oak	68, 243
-----	---------

P

Picket rail / vertical bar filling	97 - 98
Plastic hammer	315
Plate adapters	172 - 174, 218
Plate lifting tool	316
Plug	243, 304, 305
Post	82, 92, 93, 102, 122, 129, 130 -198, 137, 212, 248
Prefix	318 - 369
Profile	344 - 351, 366, 367
Promobox	319
Promomap	319

Q

Q-glue	312
Q-lights	233 - 239, 318
Q-ultra-clean	313
Quickrail®	81 - 90

R

Rubber insert	54, 298, 299
Rubber profile	54, 55, 59, 61, 62, 63, 68, 70, 298, 299
Rubber set	19, 22, 28, 32

S

Safety glass	52, 85, 148
Sample	319
Saw blade	317
Screw	300 - 304
Screw driver set	315
Screw, adjustable	301
Security pin	40, 96, 173, 174, 214 - 216, 218, 249, 282, 336
Security plate	266, 267, 270 - 272
Service	321 - 369
Side profile	22 - 26, 32 - 36
Silicon	312
Slim	18 - 26
Softstarter	237
Special adhesive	312
Spider	84, 290 - 292
Square Line®	101 - 126
Stainless steel cleaner	313
Stainless steel maintanance spray	313
Stainless steel saw	317

T

Tapping set	314
Tensioner	89, 163, 166, 169, 170
Threaded holes	131 - 133, 337, 365
Threading	314, 337, 365
Tool	314 - 317
Top mount	19 - 21, 28 - 31, 38, 39, 92, 93, 122, 123, 256, 257, 319, 344 - 346, 350, 366 - 367
Transformer	237
Tube for bars	98
Tube holder for tube	84, 97, 99, 100, 199
Tube, oval	62
Tube, round	63, 70, 85, 98, 196, 198, 223, 251
Tube, square	55, 59, 115, 119, 122, 125
Tubular bends	199

U

U-profile tube	55 - 72, 83 - 86, 145 - 148
Ultra-clean	313

V

Video	320
-------	-----

W









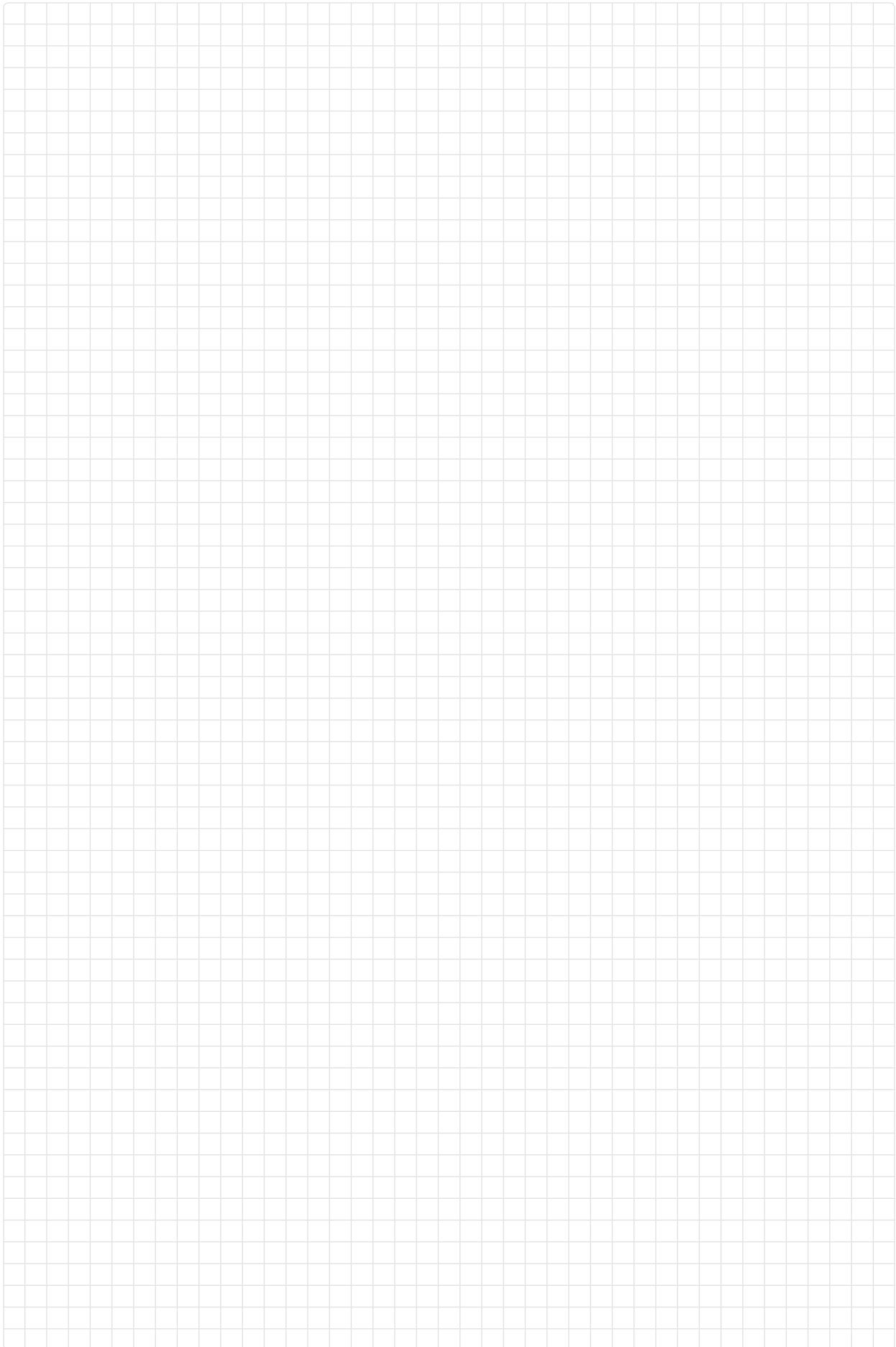



Wall flange	57, 60, 66, 72, 210, 224
Wall flange, adjustable	210
Washer	308
Web system	168 - 171
Wedge	19, 22, 28, 32
Welding parts	225 - 232
Wood	61, 68, 240 - 246, 304, 312

































304	304 Stainless steel
316	316 Stainless steel
2205	2205 Stainless steel
Aluminium	Aluminium
ABS plastic	ABS plastic
Zinc	Zinc
Zinc-plated	Zinc-plated
Brass	Brass
SATIN	Material surface
Tube - flat	Extra product information
	Packaging unit
NEW	New product
DESIGN product	Design product
	AbP-label (Allgemeines bauaufsichtliches Prüfzeugnis)
	ETB-label
	AbZ-label (Allgemeine bauaufsichtliche Zulassung)
	Tested in accordance with DIN EN 12600
	Tested in accordance with British Standard 6180
	CSTB
	fero plan-label
	Tested in accordance with NEN6702 (NEN-EN 1991-1-1)
	Tested in accordance with NEN2608 (Eurocodes 1990-1999:2011)
	LGA Typen geprüft-label
	Static calculation according to TRAV
	ITB label

INDOOR	For indoor use
OUTDOOR	For outdoor use
QS-1 	Recommended Q-screw, see page 302
Q-22	Recommended Q-tool
	Screw-fastened products (socket head wrench)
	Screw-fastened products (wrench)
	C-spanner
	Screwdriver
	Product to be driven in (Easy Hit®)
	Product to be glued
	Use wood glue
	Use a knife for cutting
	Use a saw for cutting
	Weldable products
	To be installed by an authorized electrician
IP66 IP67 IP20	Ingress Protection
	Shipping by freight company
	90° corner not possible
85mm	Wall distance 85 mm
TESTED 80 TESTED Q4INFO	Test results on page 80 / in Q-info
	Order information for compatible products
	 155...
	 299
	 253...
	 312
	 95



© 2014 Q-railing
Emmerich am Rhein, Germany

Copyright

The arrangement, catalogue layout, text, text components, tables, pictures, brands, trademarks, logos, graphics and other contents of the catalogue remain the property of Q-railing Europe GmbH & Co. KG, Germany or can be used with the consent of the owners. Subject to global copyright laws. Unless otherwise specified all brands and trademarks used in this catalogue as well as trademark laws, design patents and utility models are the property of Q-railing Europe GmbH & Co. KG, Germany or our partners. In Germany and several other countries penal and civil law prosecution of violations against copyright law, trademark law and other property rights is possible. Should you use, copy, reproduce, change in any way, translate or pass on to a third party or want to pass on specific contents or complete pages, you require our consent which we only grant in writing in advance. Therefore please ask us in advance. Otherwise we reserve the right to take legal measures against you.

PLEASE TAKE INTO CONSIDERATION:

Changes in production techniques and deviations in measurements may occur. Actual products may differ very slightly from the photographic illustration. Q-railing can not be responsible for any printing errors.

Q-railing does not accept liability, on whatever legal causes, unless there is legally compelling liability. Any compensation is hereby limited to the product value of the order - no other compensation is offered.

Please note that statutory limitations may vary from country to country. Q-railing does not accept liability for conditions and regulations that may apply to various fabrications.

Our general terms and conditions apply.

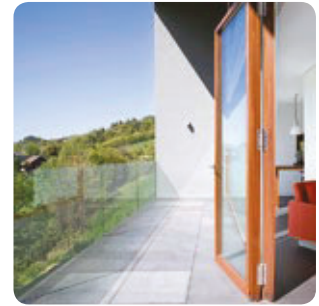
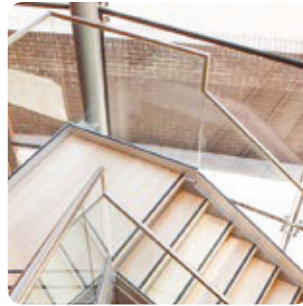



Your choice in railing systems



YOUR CHOICE IN RAILING SYSTEMS



Q-RAILING CATALOGUE 2014, UK-GB NEUTRAL • LANGUAGE EN • NO CURRENCY