



Serrures et paumelles  
*Locksets and hinges*

**ASSA ABLOY**

# Serrures *Locksets*

## LAGUNE

### Caractéristiques techniques générales

- Montage sur encoche 64A
- Réversible
- À cylindre européen panneton DIN (norme DIN 18254)
- Rappel du pêne à la clé
- Pour porte en verre trempé de 8 et 10 mm
- Condamnation par clé avec avancement du pêne
- Possibilités de combinaison avec passe général
- Livrée avec gâche plate et 3 clés

### General technical features

- To fit notch 64A
- Reversible
- European profile cylinder (DIN standard 18254)
- Return of latch bolt by key
- For toughened glass doors 8-10 mm thick
- Locked by key with forward motion of latch bolt
- Possibility of combinations with master key
- Supplied with flat keep and 3 keys

### LES + PRODUITS

The + product

Design

Certifié TUV

Nombreuses  
versions

Réversible

Elegant Design

TUV certified

Large variety  
of models

Reversible

4300

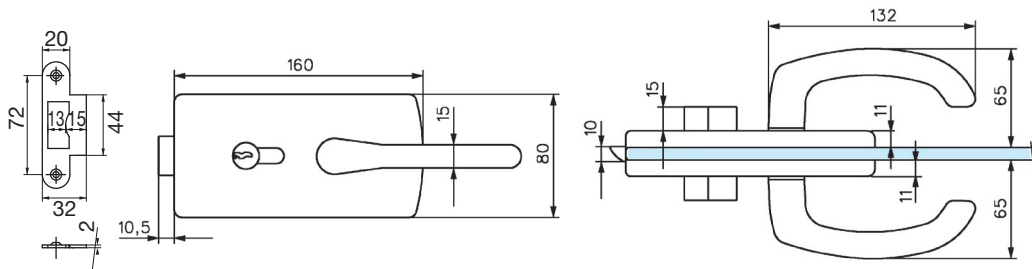
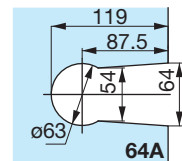

### Références / References

Serrure de milieu à cylindre  
et double béquilles  
Lock with euro profile cylinder  
and pair of handles



Laiton poli  
Polished brass



Chromé brillant  
Bright chromium



Chromé mat  
Matt chromium



Doré  
Gold plated



Laqué blanc 9010  
Lacquered white RAL 9010



4300.00.0

4300.30.0

4300.31.0

4300.40.0

4300.51.0

4309.\*\*.0

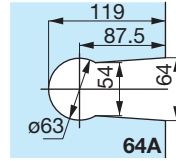

Serrures et  
paumelles  
Locksets and  
hinges

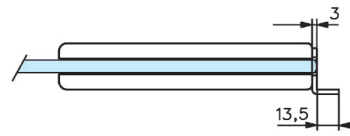
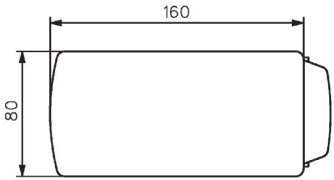

Références / References

Boîtier gâche pour serrures  
séries 4300-4310-4350  
Matching patch keep for locks series  
4300-4310-4350

Laiton poli Polished brass	Chromé brillant Bright chromium	Chromé mat Matt chromium	Doré Gold plated	Laqué blanc 9010 Lacquered white RAL 9010



4309.00.0	4309.30.0	4309.31.0	4309.40.0	4309.51.0
-----------	-----------	-----------	-----------	-----------

0309



Gâche équerre pour serrures séries 4300-4310-4350  
Keep plate with stop for locks series 4300-4310-4350

0309.30.0	0309.31.0
-----------	-----------

4306

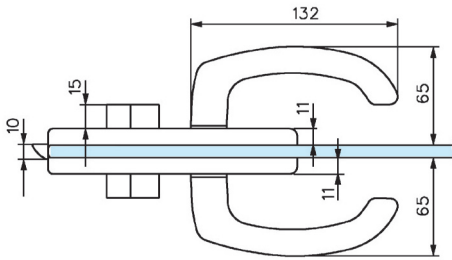
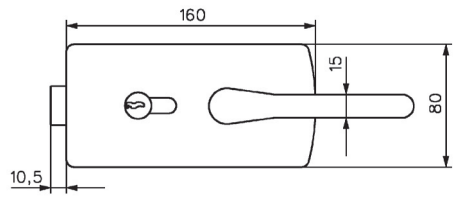
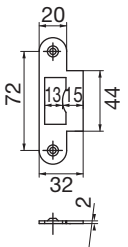
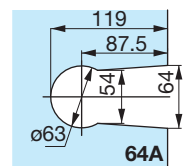

Références / References



Laiton poli Polished brass	Chromé brillant Bright chromium	Chromé mat Matt chromium

Serrure de milieu à cylindre et béquilles condamnation  
sans avancement du pêne  
Lock with euro profile cylinder and double handles, without  
forward motion of latch bolt

4306.00.0	4306.30.0	4306.31.0
-----------	-----------	-----------

4301

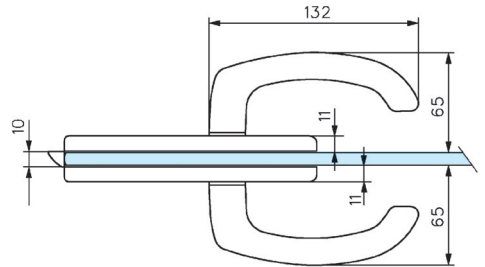
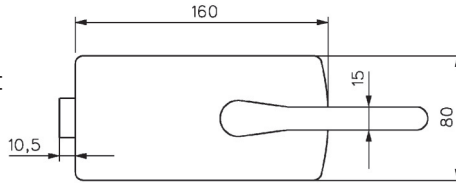
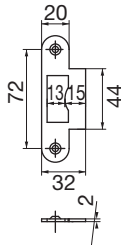
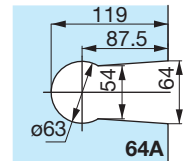

Références / References



Laiton poli  
Polished brass



Chromé brillant  
Bright chromium



Chromé mat  
Matt chromium



Doré  
Gold plated



Laqué blanc 9010  
Lacquered white RAL 9010

Serrure de milieu bec de cane et double béquilles  
Latch set with pair of handles

4301.00.0

4301.30.0

4301.31.0

4301.40.0

4301.51.0

4307

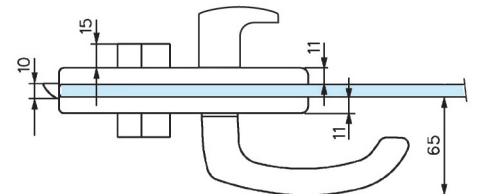
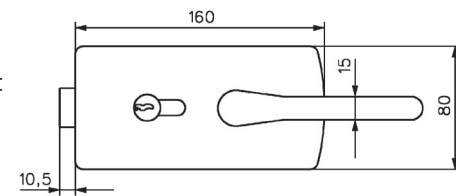
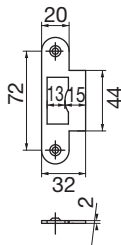
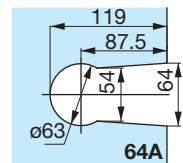

Références / References



Laiton poli  
Polished brass



Chromé brillant  
Bright chromium



Chromé mat  
Matt chromium

Serrure de milieu à cylindre avec béquille intérieure et bouton fixe extérieur, condamnation sans avancement du pêne  
Lock with euro profile cylinder, lever handle inside and fixed knob outside, without forward motion of latch bolt

4307.00.0

4307.30.0

4307.31.0

**OFFICE**

**3**



4311

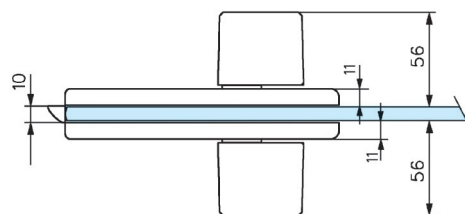
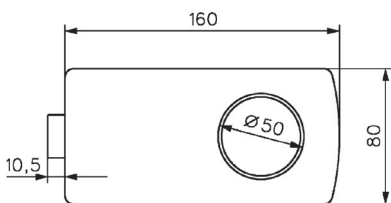
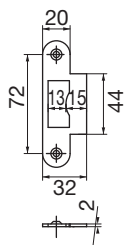
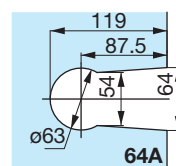

Références / References



Chromé brillant  
Bright chromium



Chromé mat  
Matt chromium



Doré  
Gold plated

Serrure de milieu bec de cane et boutons de manoeuvre  
Latch lock with pair of knobs

4311.30.0

4311.31.0

4311.40.0

4312

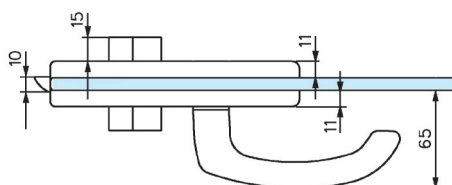
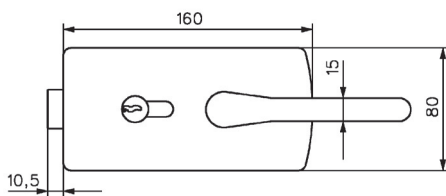
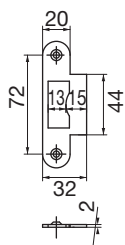
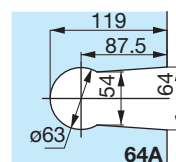

Références / References



Chromé brillant  
Bright chromium



Chromé mat  
Matt chromium

Serrure de milieu à cylindre avec une seule béquille intérieure  
Lock with euro profile cylinder and lever handle inside only

4312.30.0

4312.31.0

4314

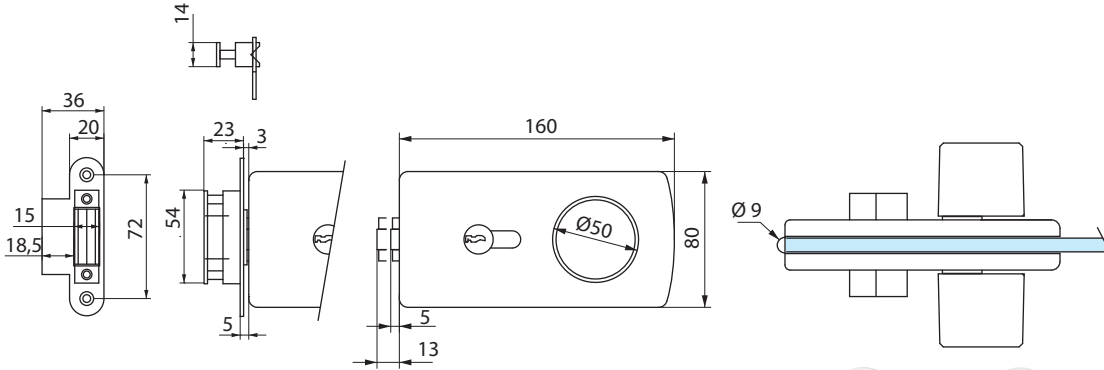
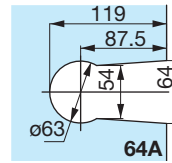

Références / References



Serrure de milieu à cylindre, rouleau et boutons fixes  
 Lock with euro profile cylinder, roller bolt and fixed knobs



4314.30.0

4314.31.0

4309.\*\*.1

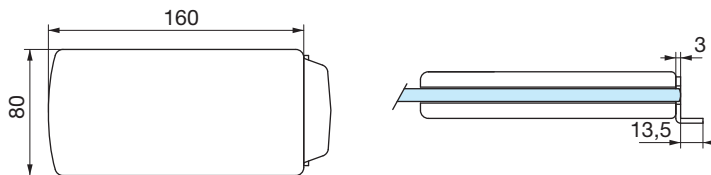
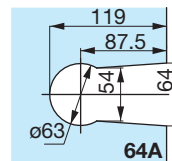

Références / References



Boîtier gâche pour serrure série 4314  
 Matching patch keep for lock series 4314



4309.30.1

4309.31.1

4360

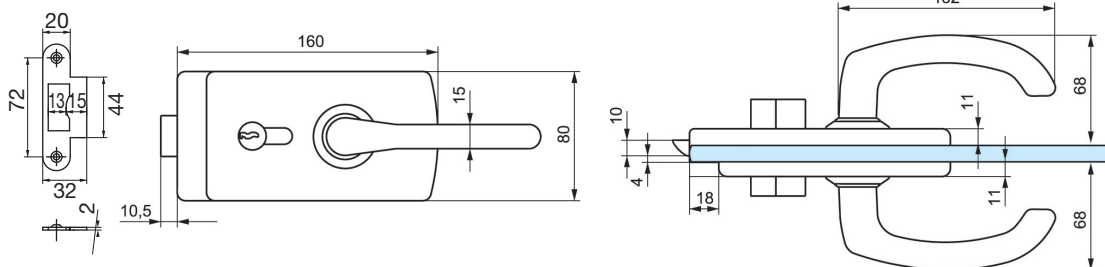
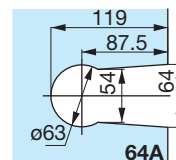

Références / References

Serrure de milieu à cylindre et béquilles avec déport, pêne axé  
Lock with euro profile cylinder, handles and offset mechanism



Chromé brillant  
Bright chromium



Chromé mat  
Matt chromium



Doré  
Gold plated



Laqué blanc 9010  
Lacquered white RAL 9010



4360.30.0

4360.31.0

4360.40.0

4360.51.0



4360.30.4

4360.31.4

• Le mécanisme déporté permet un contact de la porte en fond de feuillure, et assure la continuité du joint au niveau de la serrure.

• *Offset mechanism to allow compression of rebate strip.*

LES + PRODUITS

Mécanisme déporté

Offset mechanism

4361

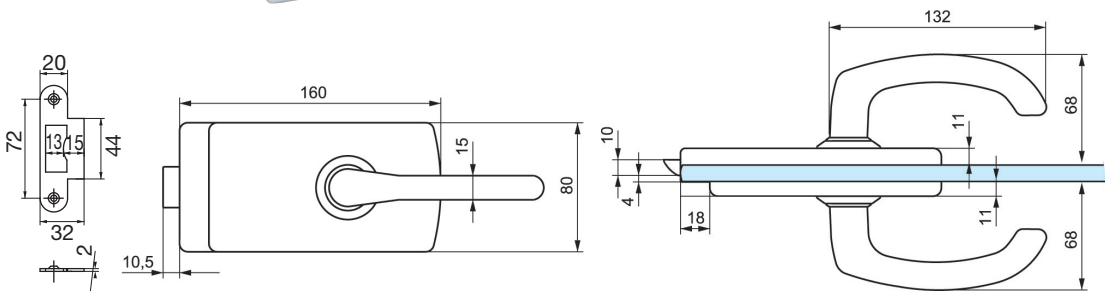
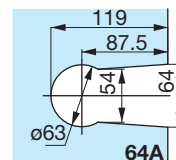

Références / References

Serrure de milieu bec de cane et béquilles avec déport, pêne axé  
Latch set with handles and offset mechanism



Chromé brillant  
Bright chromium



Chromé mat  
Matt chromium



Doré  
Gold plated



Laqué blanc 9010  
Lacquered white RAL 9010



4361.30.0

4361.31.0

4361.40.0

4361.51.0



4361.30.4

4361.31.4

• Le mécanisme déporté permet un contact de la porte en fond de feuillure, et assure la continuité du joint au niveau de la serrure.

• *Offset mechanism to allow compression of rebate strip.*



## 4360.0BT

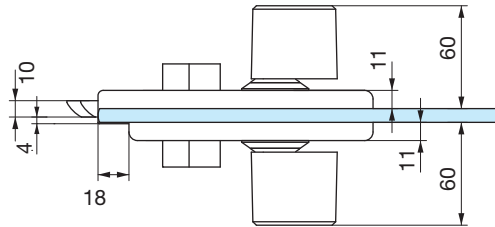
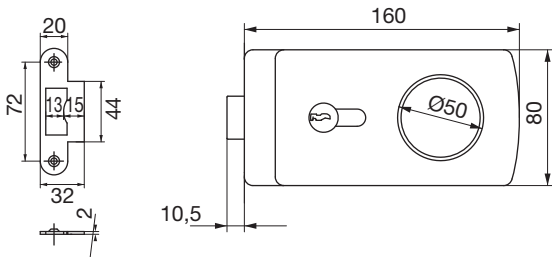
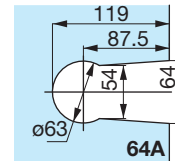

### Références / References



Chromé brillant  
Bright chromium



Chromé mat  
Matt chromium



Laqué blanc 9010  
Lacquered white RAL 9010

Serrure de milieu à cylindre et boutons de manoeuvre avec déport, pêne axé  
Lock with euro profile cylinder with pair of knobs and offset mechanism

4360.30.0BT

4360.31.0BT

4360.51.0BT

- Le mécanisme déporté permet un contact de la porte en fond de feuillure, et assure la continuité du joint au niveau de la serrure.

- Offset mechanism to allow compression of rebate strip.

## 4361.0BT

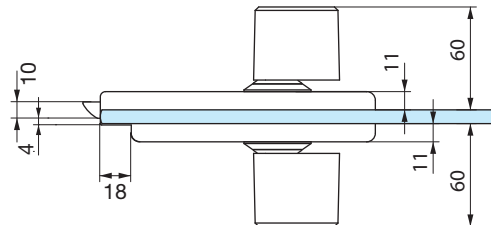
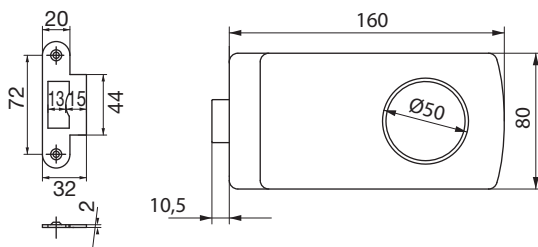
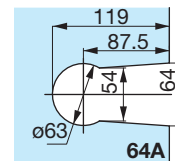

### Références / References



Chromé brillant  
Bright chromium



Chromé mat  
Matt chromium



Laqué blanc 9010  
Lacquered white RAL 9010

Serrure de milieu bec de cane avec déport et 2 boutons de manoeuvre  
Latch set with knobs and offset mechanism

4361.30.0BT

4361.31.0BT

4361.51.0BT

- Le mécanisme déporté permet un contact de la porte en fond de feuillure, et assure la continuité du joint au niveau de la serrure.

- Offset mechanism to allow compression of rebate strip.

Serrures et paumelles  
Locksets and hinges

4363.0E\*T

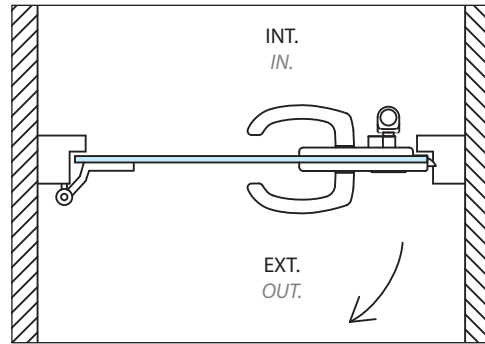
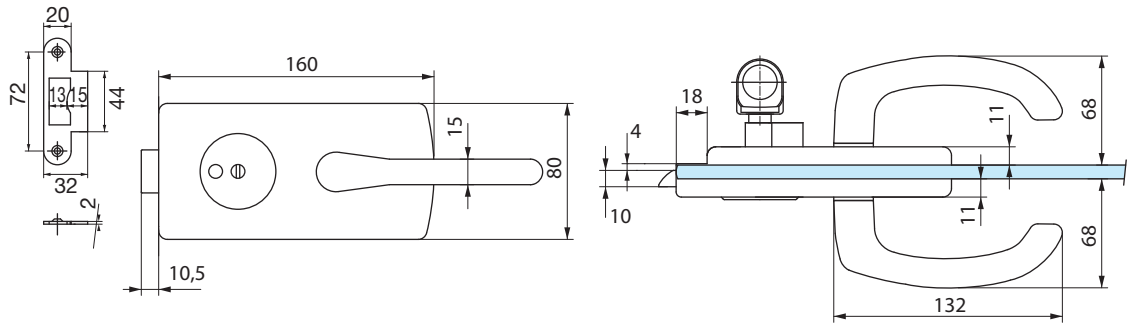
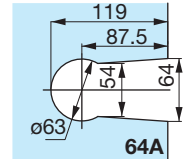

LES + PRODUITS

Mécanisme déporté

Idéal pour cabine et vestiaire

Sécurité : décondamnation d'urgence

Offset mechanism

Ideal for toilets and cloakrooms

Security : emergency exit

Références / References



Serrure avec voyant ouverture extérieure droite tirant  
Lock with colour indicator outside opening right pull



Chromé brillant  
Bright chromium



Chromé mat  
Matt chromium

4363.30.0EDT 4363.31.0EDT

- Le mécanisme déporté permet un contact de la porte en fond de feuillure, et assure la continuité du joint au niveau de la serrure.

- Offset mechanism to allow compression of rebate strip.

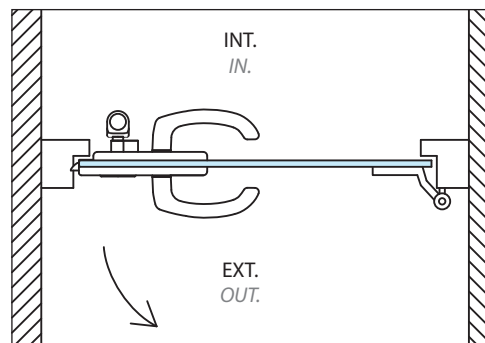

Références / References



Serrure avec voyant ouverture extérieure gauche tirant  
Lock with colour indicator outside opening left pull



Chromé brillant  
Bright chromium



Chromé mat  
Matt chromium

4363.30.0EGT 4363.31.0EGT

- Le mécanisme déporté permet un contact de la porte en fond de feuillure, et assure la continuité du joint au niveau de la serrure.

- Offset mechanism to allow compression of rebate strip.

4363.01\*P

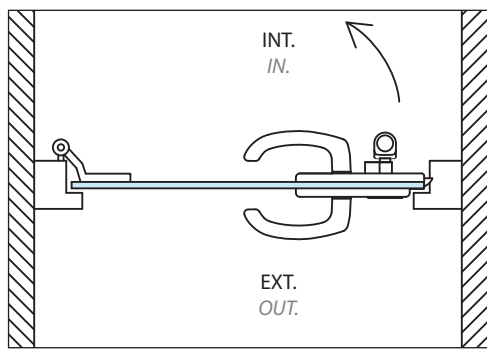
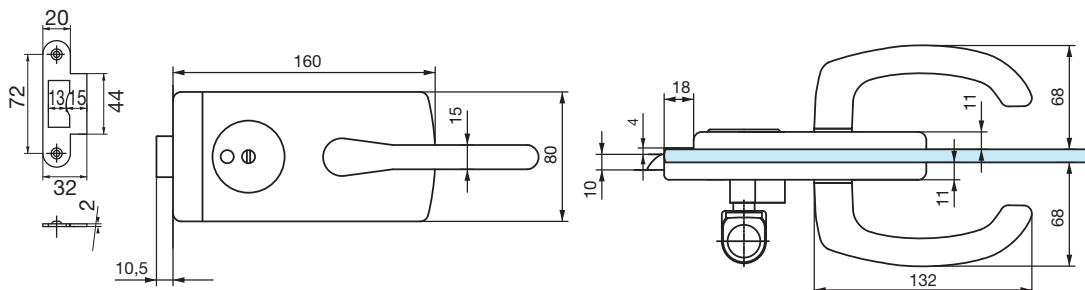
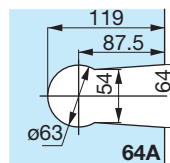

Références / References



Chromé brillant  
Bright chromium



Chromé mat  
Matt chromium

Serrure avec voyant ouverture intérieure droite poussant  
Lock with colour indicator inside opening right push

4363.30.0IDP 4363.31.0IDP

- Le mécanisme déporté permet un contact de la porte en fond de feuillure, et assure la continuité du joint au niveau de la serrure.

- Offset mechanism to allow compression of rebate strip.

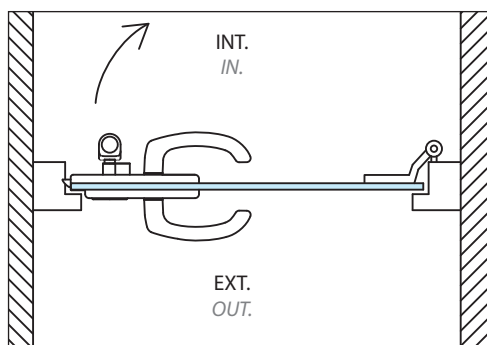

Références / References



Chromé brillant  
Bright chromium



Chromé mat  
Matt chromium

Serrure avec voyant ouverture intérieure gauche poussant  
Lock with colour indicator inside opening left push

4363.30.0IGP 4363.31.0IGP

- Le mécanisme déporté permet un contact de la porte en fond de feuillure, et assure la continuité du joint au niveau de la serrure.

- Offset mechanism to allow compression of rebate strip.

4367.0\*\*

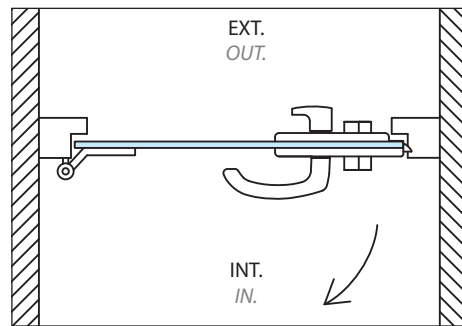
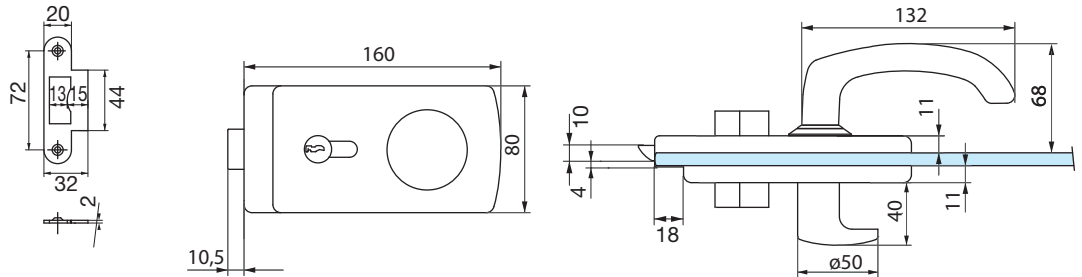
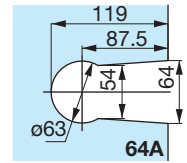

LES + PRODUITS

Mécanisme  
déporté

Offset mechanism

Références / References



Chromé brillant  
Bright chromium



Chromé mat  
Matt chromium

Serrure de milieu à cylindre et déport avec béquille intérieure  
et bouton fixe extérieur, condamnation sans avancement du pêne  
*Lock with euro profile cylinder and offset with handle inside  
fixed knob outside, without forward latch bolt motion*

4367.30.0AD

4367.31.0AD

- Le mécanisme déporté permet un contact de la porte en fond de feuillure, et assure la continuité du joint au niveau de la serrure.

- Offset mechanism to allow compression of rebate strip.

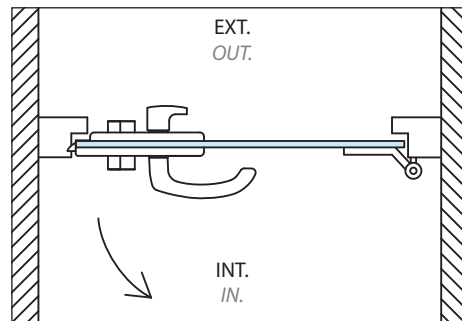

Références / References



Chromé brillant  
Bright chromium



Chromé mat  
Matt chromium

Serrure de milieu à cylindre et déport avec béquille intérieure  
et bouton fixe extérieur, condamnation sans avancement du pêne  
*Lock with euro profile cylinder and offset with handle inside  
fixed knob outside, without forward latch bolt motion*

4367.30.0BC

4367.31.0BC

- Le mécanisme déporté permet un contact de la porte en fond de feuillure, et assure la continuité du joint au niveau de la serrure.

- Offset mechanism to allow compression of rebate strip.

4366

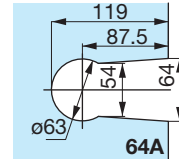

Serrures et  
paumelles  
Locksets and  
hinges

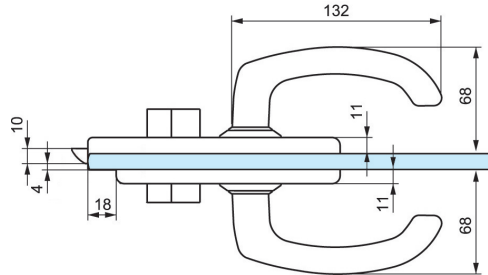
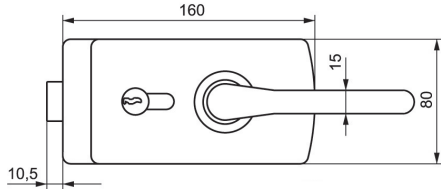
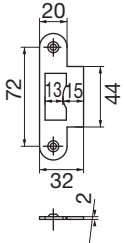

Références / References



Chromé mat  
Matt chromium

Serrure de milieu à barillet et béquilles avec déport, condamnation sans avancement de pêne  
Lock with euro profile cylinder offset and handles without forward motion of latch bolt

4366.31.0

- Le mécanisme déporté permet un contact de la porte en fond de feuillure, et assure la continuité du joint au niveau de la serrure.

- Offset mechanism to allow compression of rebate strip.

4380

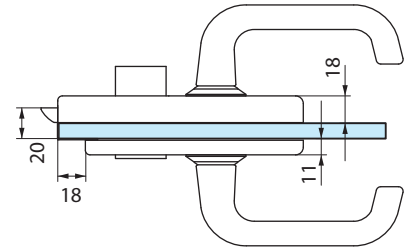
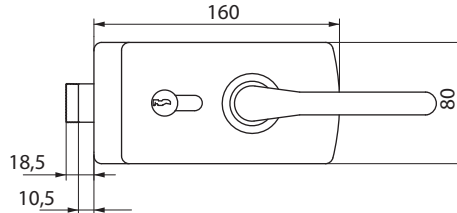
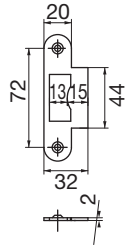
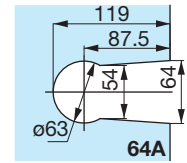

Références / References

Serrure de milieu à cylindre et béquilles avec déport, pêne désaxé, condamnation sans avancement de pêne  
Lock set with handles, offset mechanism and spring bolt without forward motion of latch bolt



Chromé brillant  
Bright chromium



Chromé mat  
Matt chromium



Laqué blanc 9010  
Lacquered white RAL 9010



4380.30.0

4380.31.0

4380.51.0



4380.31.4

- Le mécanisme déporté permet un contact de la porte en fond de feuillure, et assure la continuité du joint au niveau de la serrure.

- Offset mechanism to allow compression of rebate strip.

4381

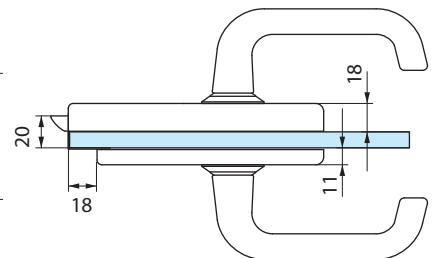
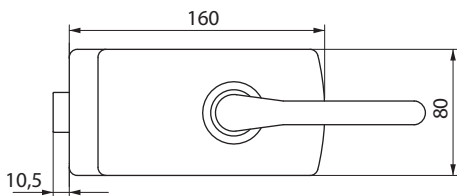
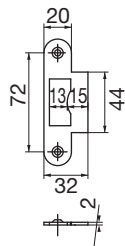
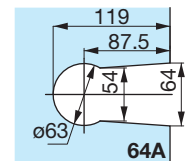

Références / References



Chromé brillant  
Bright chromium

4381.30.0

Chromé mat  
Matt chromium

4381.31.0

Laqué blanc 9010  
Lacquered white RAL 9010

4381.51.0

Serrure de milieu bec de cane et béquilles avec déport, pêne désaxé, condamnation sans avancement de pêne  
Latch with euro profile cylinder with handles, offset mechanism and spring bolt, without forward motion of latch bolt

- Le mécanisme déporté permet un contact de la porte en fond de feuillure, et assure la continuité du joint au niveau de la serrure.

- Offset mechanism to allow compression of rebate strip.

4389

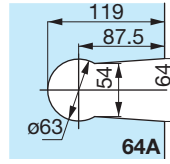

Serrures et  
paumelles  
Locksets and  
hinges

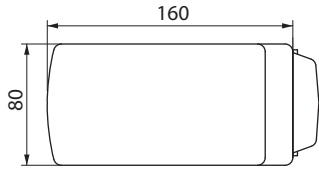

Références / References



Boîtier gâche pour serrures série 4380  
Matching patch keep for locks series 4380



Chromé brillant  
Bright chromium

4389.30.0



Chromé mat  
Matt chromium

4389.31.0



Serrures et  
paumelles  
*Locksets and  
hinges*

# BASTILLE

## Caractéristiques techniques

- Pour verre trempé de 8 – 10 et 12 mm
- Montage sur encoche 6300EX
- Réversible
- A cylindre européen panneton DIN (norme DIN 18254)
- Avec caches cylindre
- Rappel du pêne à la clé
- Condamnation avec avancement du pêne
- Possibilités de combinaison avec passe général
- Livrée avec gâche plate et 3 clés

## Technical features

- For 8 -10 and 12 mm thick toughened glass
- To fit notch 6300EX
- Reversible
- European profile cylinder (DIN standard 18254)
- With cylinder covers
- Return of the latch bolt by key
- Locked with forward motion of latch bolt
- Possibility of combinations with master key
- Supplied with flat keep and 3 keys

## LES + PRODUITS

*The + product*

Design épuré

Certifié TUV

Grande qualité  
de finition

Mécanisme  
de précision

Réversible

*Refined design*

*TUV certified*

*High quality finishes*

*Precision mechanics*

*Reversible*

- **Le mécanisme déporté permet un contact de la porte en fond de feuillure, et assure la continuité du joint au niveau de la serrure.**

- **Offset mechanism to allow compression of rebate strip.**





4501

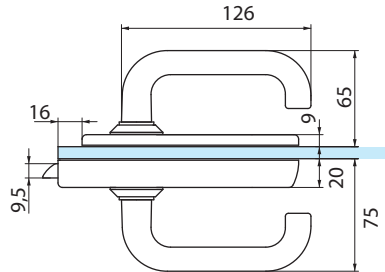
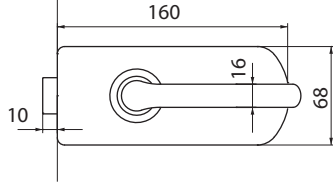
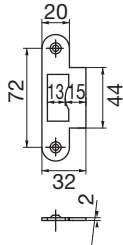
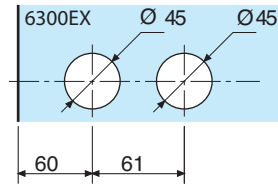

Références / References



Laiton poli PVD  
Polished brass PVD



Chromé brillant  
Bright chromium



Chromé mat  
Matt chromium



Effet inox  
Stainless steel effect

Serrure de milieu bec de cane  
et béquilles  
Latch set with pair of handles

4501.05.0

4501.30.0

4501.31.0

4501.35.0

4550.\*\*.\*

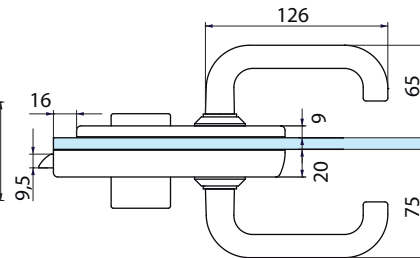
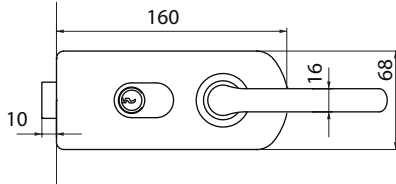
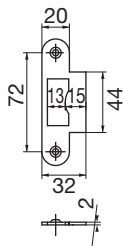
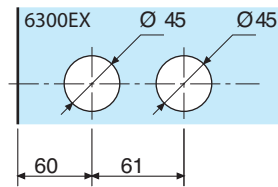

Références / References

Serrure de milieu à cylindre et double  
béquilles, caches cylindre  
Lock with euro profile  
cylinder, pair of handles  
and cylinder cover



Laiton poli PVD  
Polished brass PVD



Chromé brillant  
Bright chromium



Chromé mat  
Matt chromium



Effet inox  
Stainless steel effect



4550.05.0

4550.30.0

4550.31.0

4550.35.0



4550.05.4

4550.30.4

4550.31.4

4550.35.4



4550.05.5

4550.30.5

4550.31.5

4550.35.5

4555.\*\*.0

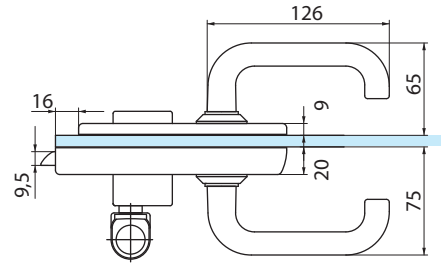
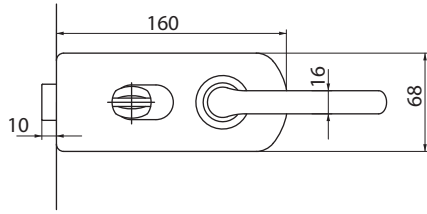
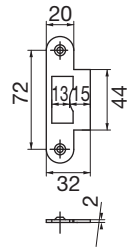
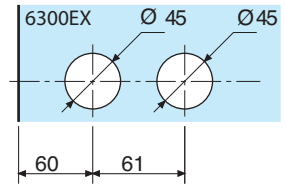

Références / References

Serrure de milieu avec cylindre à bouton et double béquilles, caches cylindre  
Lock with thumb turn cylinder, pair of handles and cylinder cover



Laiton poli PVD  
Polished brass PVD



Chromé brillant  
Bright chromium



Chromé mat  
Matt chromium



Effet inox  
Stainless steel effect



4555.05.0

4555.30.0

4555.31.0

4555.35.0



4555.05.4

4555.30.4

4555.31.4

4555.35.4



4555.05.5

4555.30.5

4555.31.5

4509

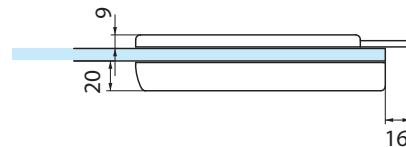
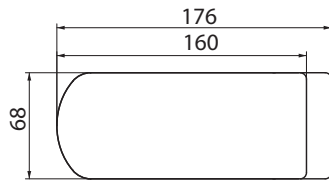
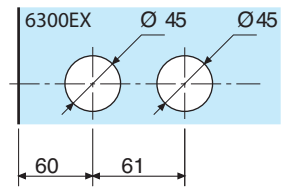

Références / References



Boîtier gâche pour serrures série 4500  
Matching patch keep for locks series 4500



Laiton poli PVD  
Polished brass PVD



Chromé brillant  
Bright chromium



Chromé mat  
Matt chromium



Effet inox  
Stainless steel effect

4509.05.0

4509.30.0

4509.31.0

4509.35.0

Serrures et  
paumelles  
*Locksets and  
hinges*



# LUMIRA HORIZONTALE

## Caractéristiques techniques

- Pour verre trempé de 8, 10 et 12 mm
- Montage sur encoche 6300EX
- Réversible
- Condamnation par clé avec avancement du pêne
- Rappel du pêne tour à la clé
- Livré avec gâche plate

## Technical features

- For 8- 10 and 12 mm thick toughened glass
- To fit notch 6300EX
- Reversible
- Locked by key with forward motion of latch bolt
- Retractable latch bolt by key
- Supplied with flat keep

## LES + PRODUITS

The + product

Mécanisme  
déporté

Résistance à l'usage  
intensif

Nombreuses  
versions

Offset mechanism

Resistance  
to heavy use

Large variety  
of models

V525

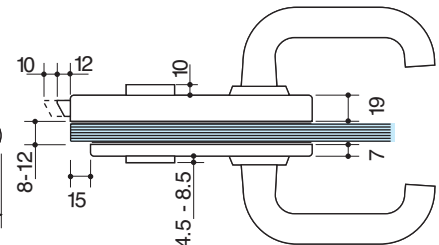
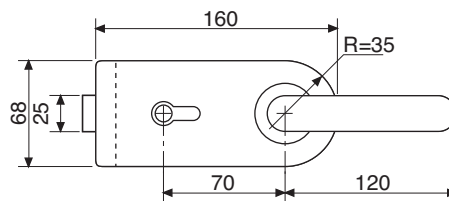
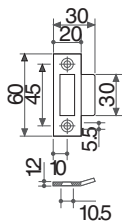
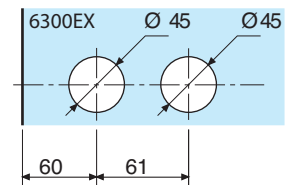

## Références / References



Serrure de milieu avec cylindre Européen  
avec béquilles  
Lock with euro profile cylinder and handles



Aluminium anodisé Argent Brossé  
Brushed anodised alu silver

V525.12



Chromé mat brossé  
Brushed matt chromium

V525.33

- Le mécanisme déporté permet un contact de la porte en fond de feuillure, et assure la continuité du joint au niveau de la serrure.

- Offset mechanism to allow compression of rebate strip.

## V525.2.\*\*

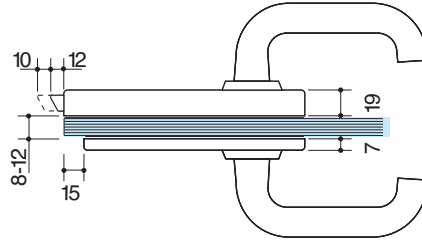
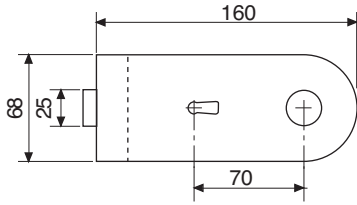
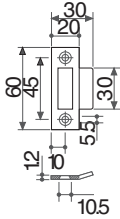
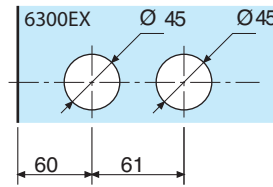

### Références / References



Serrure de milieu avec clé à panneton avec béquille.  
Lock with one bb-key and handles.



Aluminium anodisé Argent Brossé  
Brushed anodised alu silver

V525.2.12



Chromé mat brossé  
Brushed matt chromium

V525.2.33

- Le mécanisme déporté permet un contact de la porte en fond de feuillure, et assure la continuité du joint au niveau de la serrure.

- Offset mechanism to allow compression of rebate strip.

## V526

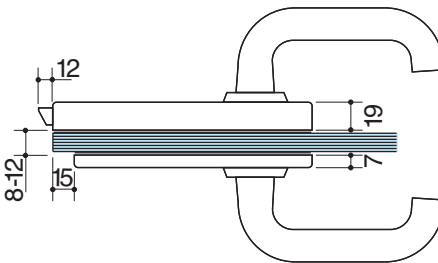
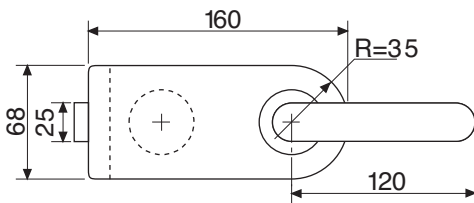
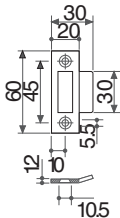
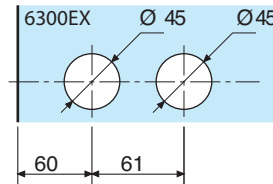

### Références / References



Serrure de milieu avec béquille  
Latch set with handles



Aluminium anodisé Argent Brossé  
Brushed anodised alu silver

V526.12



Chromé mat brossé  
Brushed matt chromium

V526.33

- Le mécanisme déporté permet un contact de la porte en fond de feuillure, et assure la continuité du joint au niveau de la serrure.

- Offset mechanism to allow compression of rebate strip.

V350

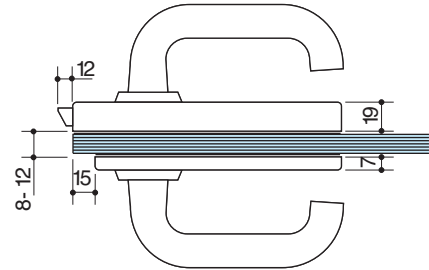
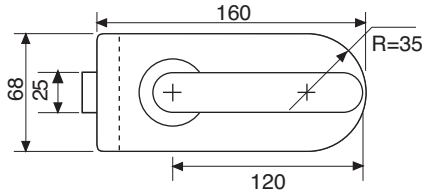
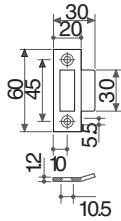
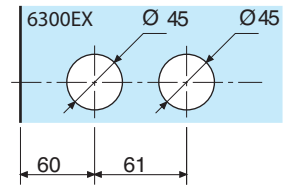

Références / References



Serrure de milieu avec béquilles  
Latch set with handles



V350.12

V350.33

- Le mécanisme déporté permet un contact de la porte en fond de feuillure, et assure la continuité du joint au niveau de la serrure.

- Offset mechanism to allow compression of rebate strip.

V310

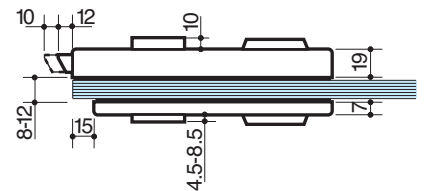
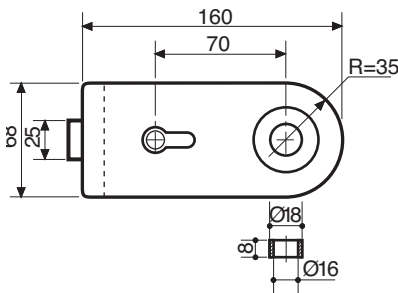
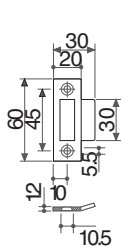
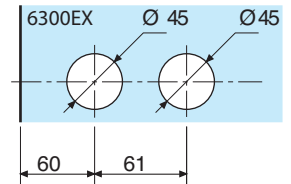

Références / References



Serrure de milieu sans cylindre (V017) et pour bouton ou double béquilles  
Lock without cylinder (V017) and pair of handles or knobs



V310.12

V310.15

V310.33

V310.36

- Le mécanisme déporté permet un contact de la porte en fond de feuillure, et assure la continuité du joint au niveau de la serrure.

- Offset mechanism to allow compression of rebate strip.

# V320

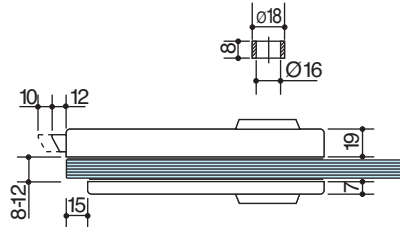
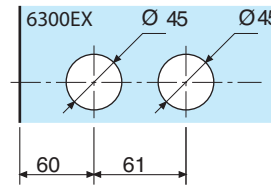
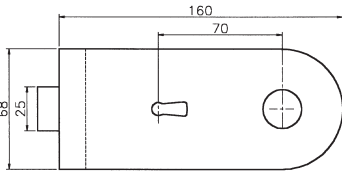
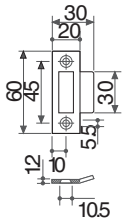

Serrures et  
paumelles  
Locksets and  
hinges

### Références / References



Serrure de milieu avec clé à panneton sans béquille  
Lock with one bb-key without handles



Aluminium anodisé Argent Brossé  
Brushed anodised alu silver



Inox Brossé  
Brushed stainless steel



Chromé mat brossé  
Brushed matt chromium



Aluminium anodisé Aninox  
Brushed anodised alu.

V320.12

V320.15

V320.33

V320.36

• Le mécanisme déporté permet un contact de la porte en fond de feuillure, et assure la continuité du joint au niveau de la serrure.

• *Offset mechanism to allow compression of rebate strip.*

# V330

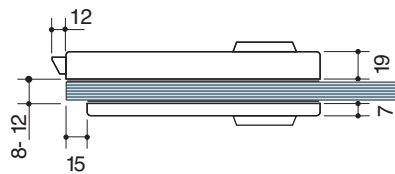
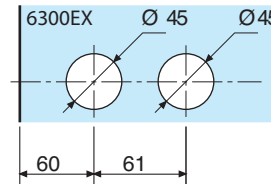
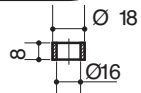
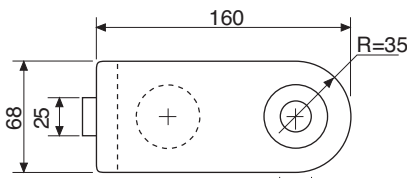
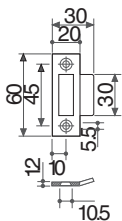

### Références / References



Serrure de milieu sans béquille  
Latch set without handles



Aluminium anodisé Argent Brossé  
Brushed anodised alu silver



Inox Brossé  
Brushed stainless steel



Chromé mat brossé  
Brushed matt chromium



Aluminium anodisé Aninox  
Brushed anodised alu.

V330.12

V330.15

V330.33

V330.36

• Le mécanisme déporté permet un contact de la porte en fond de feuillure, et assure la continuité du joint au niveau de la serrure.

• *Offset mechanism to allow compression of rebate strip.*

V340

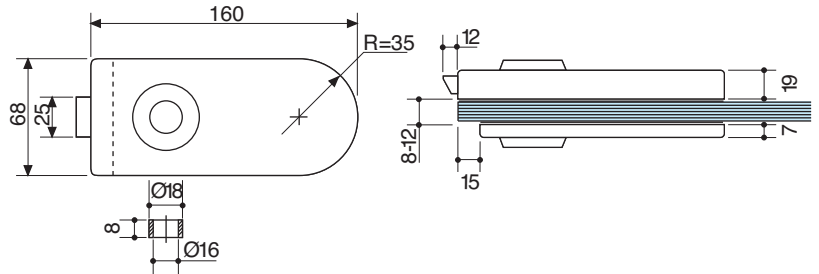
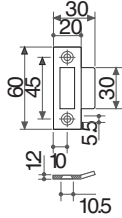
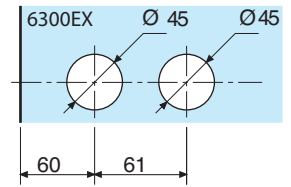

Références / References



Serrure de milieu sans béquille  
Latch set without handles



V340.12

V340.15

V340.33

V340.36

- Le mécanisme déporté permet un contact de la porte en fond de feuillure, et assure la continuité du joint au niveau de la serrure.

- Offset mechanism to allow compression of rebate strip.

V527

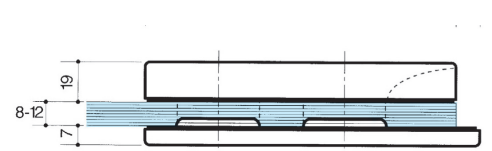
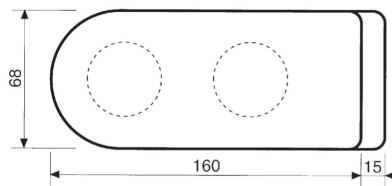
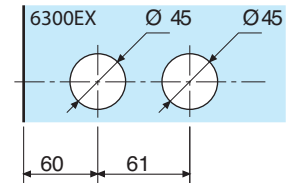

Références / References



Boîtier Gâche pour serrure de milieu série Lumira horizontale.  
Matching patch keep for lock series Lumira horizontal



V527.12

V527.15

V527.33

V527.36







V750

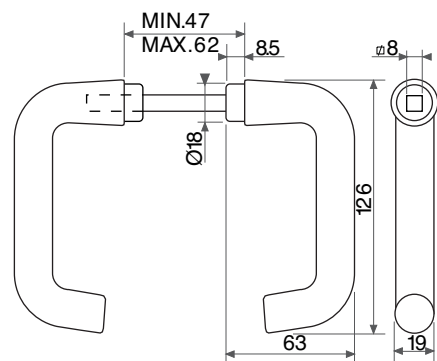
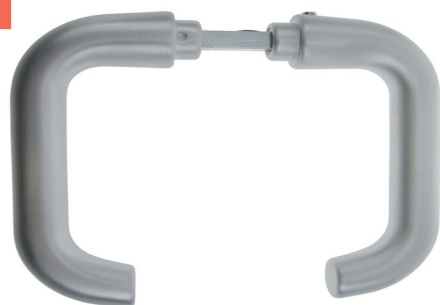

Aluminium anodisé Argent Brossé  
Brushed anodised alu silver



Inox Brossé  
Brushed stainless steel



Chromé mat brossé  
Brushed matt chromium

V750.12

V750.15

V750.33

Références / References

Paire de béquilles forme ronde  
pour V310, V320, V330 et V340  
Pair of lever handles rounded design  
for V310, V320, V330 and V340

V525.5.\*\*

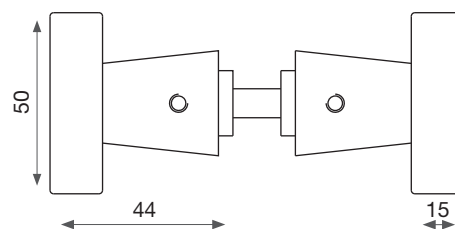

Aluminium anodisé Argent Brossé  
Brushed anodised alu silver

Références / References

Paire de boutons pour V310, V320, V330 et V340  
Pair of door knobs for V310, V320, V330 and V340

V525.5.12

V554.2

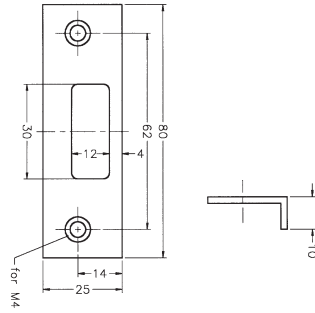
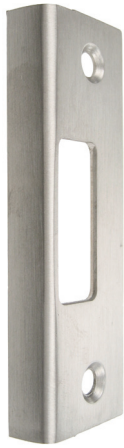

Inox Brossé  
Brushed stainless steel

Références / References

Gâche pour V310, V320, V330 et V340 type allemand  
Keep plate for V310, V320, V330 and V340 german style

V554.2.15

V533.1

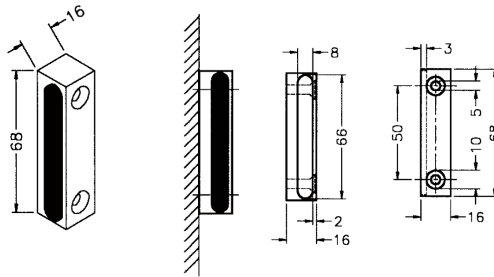

Laiton poli verni  
Polished varnished brass



Aluminium anodisé Argent Brossé  
Brushed anodised alu silver



Chromé brillant  
Bright chromium



Chromé mat brossé  
Brushed matt chromium



Aluminium anodisé Aninox  
Brushed anodised alu.

Références / References

Butée pour serrure de milieu  
Wall stop for locks

V533.1.01

V533.1.12

V533.1.30

V533.1.33

V533.1.36

4391.00V0

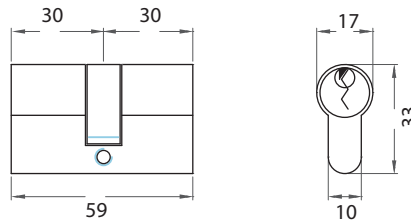

Références / References



Cylindre Européen 30/30 mm  
Europrofile cylinder 30/30 mm

4391.00V0

Serrures et paumelles  
Locksets and hinges

# LUMIRA VERTICALE

## Caractéristiques techniques

- Pour verre trempé de 8, 10 et 12 mm
- Montage sur encoche V370E
- Avec pêne demi tour et pêne dormant

## Technical features

- For 8-10 and 12 mm thick toughened glass
- To fit notch V370E
- With spring and dead bolt



## LES + PRODUITS

The + product

Grande qualité de finition

Résistance à l'usage intensif

Sécurité accrue

High quality finishes

Resistance to heavy use

Increased security

V360

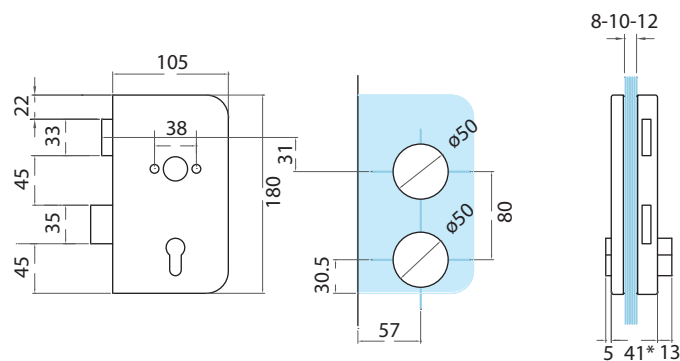
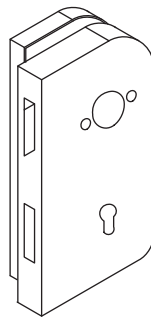

\*=10mm

## Références / References



Serrure de milieu pour cylindre Européen sans béquille, DIN droite  
Lock for Euro profile cylinder without handles DIN right

Aluminium anodisé Argent Brossé  
Brushed anodised alu silver

Inox Brossé  
Brushed stainless steel

V360.12

V360.15

V370

Serrures et  
paumelles  
Locksets and  
hinges

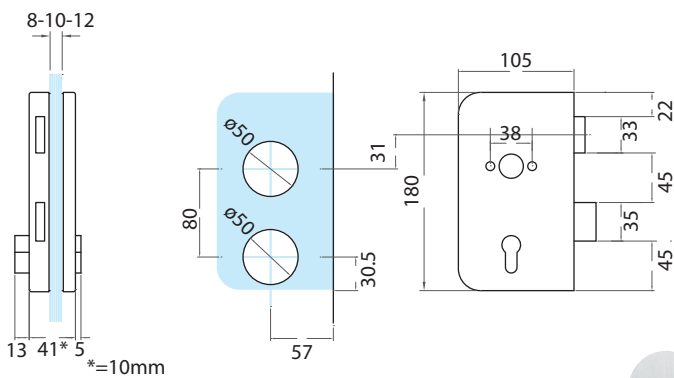
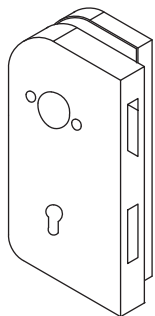

Références / References



Serrure de milieu pour cylindre Européen sans béquille, DIN gauche  
Lock for Euro profile cylinder without handles DIN left

V370.12

V370.15

V367

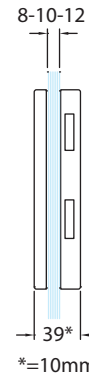
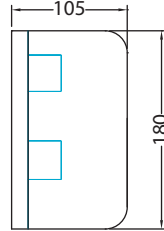
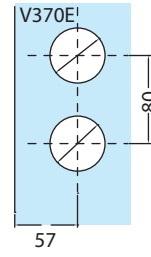
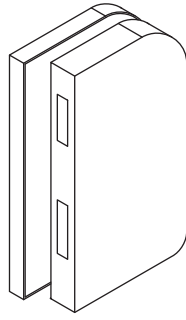

Références / References



Boîtier gâche pour serrure de milieu pour V370 / DIN droite  
Matching patch keep for lock V370 / DIN right

Aluminium anodisé Argent Brossé  
Brushed anodised alu silver

Inox Brossé  
Brushed stainless steel

V367.12

V367.15

V377

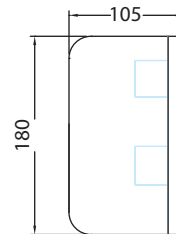
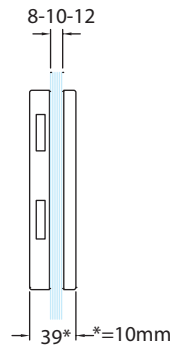
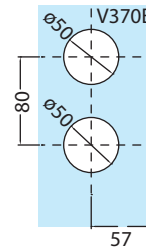
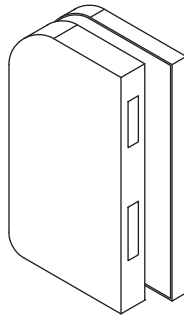

Références / References



Boîtier gâche pour serrure de milieu pour V360 / DIN gauche  
Matching patch keep for centre lock V360 / DIN left

Aluminium anodisé Argent Brossé  
Brushed anodised alu silver

Inox Brossé  
Brushed stainless steel

V377.12

V377.15

V770

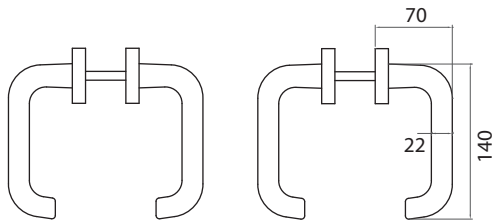

Aluminium anodisé Argent Brossé  
Brushed anodised alu silver



Inox Brossé  
Brushed stainless steel

Références / References

Paire de béquilles avec rosace pour V360 et V370  
Pair of lever handles with rosettes for V360 and V370

V770.12

V770.15

V780

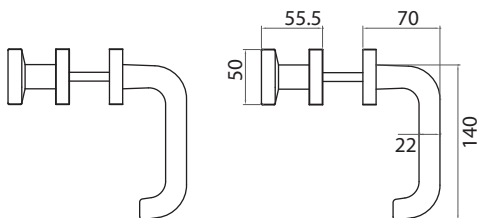
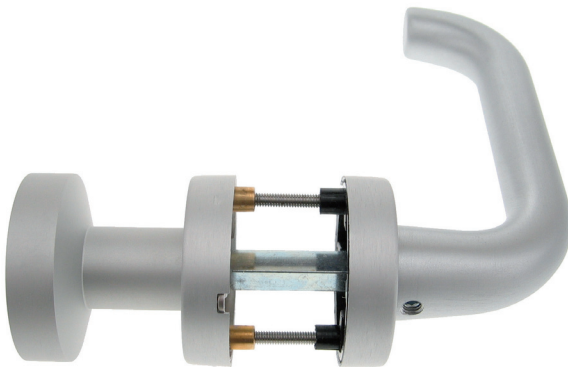

Aluminium anodisé Argent Brossé  
Brushed anodised alu silver



Inox Brossé  
Brushed stainless steel

Références / References

Bouton fixe / béquille pour V360 et V370  
Combination fixed knob / lever handle for V360 and V370

V780.12

V780.15

Serrures et  
paumelles  
Locksets and  
hinges



V533.1

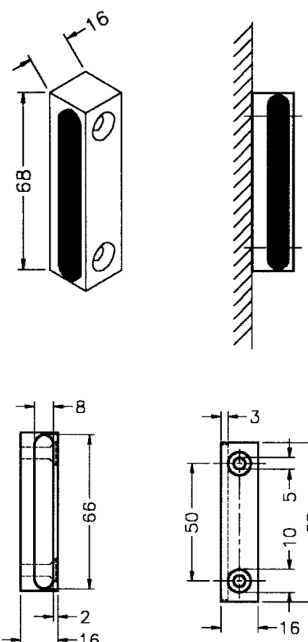

Laiton poli verni  
Polished varnished brass



Aluminium anodisé Argent Brossé  
Brushed anodised alu silver



Chromé brillant  
Bright chromium



Chromé mat brossé  
Brushed matt chromium



Aluminium anodisé Aninox  
Brushed anodised alu.

Références / References

Butée pour serrure de milieu  
Wall stop for lock

V533.1.01

V533.1.12

V533.1.30

V533.1.33

V533.1.36



## V2140

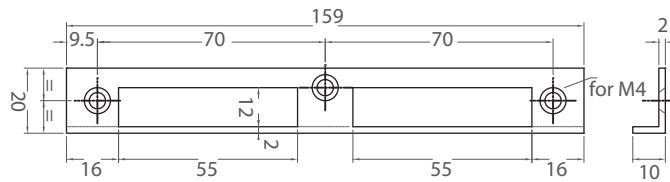

Inox Brossé  
Brushed stainless steel

### Références / References

Gâche forme L pour V360, V361, V370 et V371  
Keep plate L shape for V360, V361, V370, and V371

V2140.15

## V2140.2

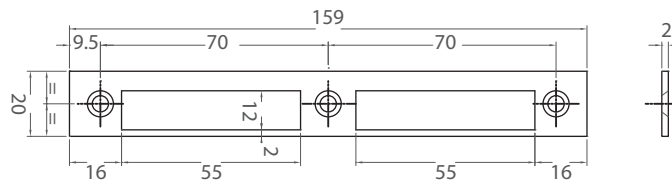

Inox Brossé  
Brushed stainless steel

### Références / References

Gâche pour V360, V361, V370 et V371  
Keep plate for V360, V361, V370 and V371

V2140.2.15

## 4391.00V0

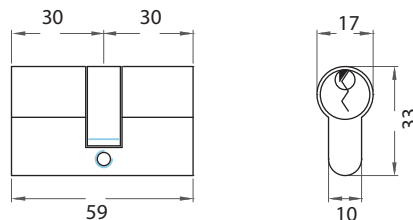

### Références / References

Cylindre Européen 30/30 mm  
Europrofile cylinder 30/30 mm

4391.00V0

# CLASSIC



## Caractéristiques techniques

- Pour verre trempé de 8, 10 mm
- Montage sur encoche 64A avec cale d'encoche et sur les anciennes encoches 60A, 60B, 64
- Réversible par retournement du pêne demi-tour pour adaptation selon sens d'ouverture de la porte
- Pêne demi tour et pêne dormant indépendants
- A cylindres avec protection par bagues tournantes
- Rappel du demi-tour à la clé
- Livré avec gâche plate, 3 clés et cale d'encoche

## Technical features

- For 8 and 10 mm thick toughened glass
- To fit notch 64A with notch wedge supplied and on notches 60A, 60B and 64
- Reversible by altering latch bolt to adapt to the opening direction of the door
- Individual latch and dead bolt
- Protected cylinder
- Return of latch bolt with moring collar
- Supplied with flat keep, 3 keys and notch wedge

## LES + PRODUITS

The + product

Grande qualité de finition

Compatible anciennes encoches

Sécurité : pêne dormant indépendant

High quality finishes

Compatible with long standing notches

Security : independant bolt

1300

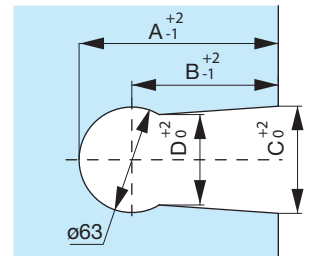

Encoche	A	B	C	D
60A	94,5	62	62	51
60B	94,5	63	65	57
64	110	78,5	65	54
64A	119	87,5	64	54

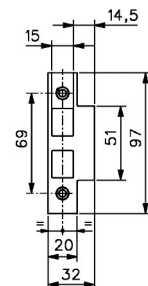
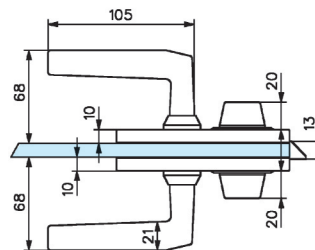
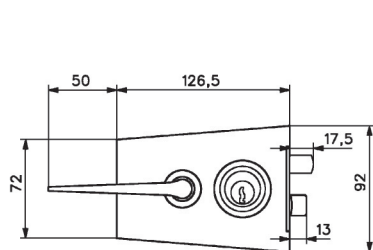

## Références / References



Laiton poli  
Polished brass



Chromé brillant  
Bright chromium



Chromé mat  
Matt chromium

Serrure de milieu à cylindre et double béquilles  
Lock with euro profile cylinder and double handles

1300.00.0

1300.30.0

1300.31.0

1309

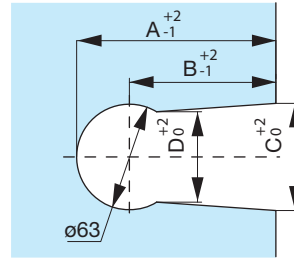
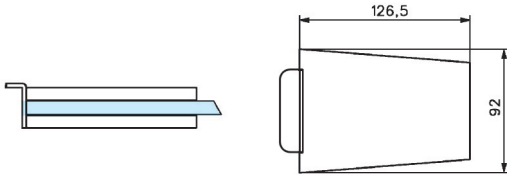

Encoche	A	B	C	D
60A	94,5	62	62	51
60B	94,5	63	65	57
64	110	78,5	65	54
64A	119	87,5	64	54

Références / References



Boîtier gâche pour serrures série 1300  
 Matching patch keep for locks series 1300



Laiton poli  
 Polished brass



Chromé brillant  
 Bright chromium



Chromé mat  
 Matt chromium

1309.00.0

1309.30.0

1309.31.0

Serrures et  
 paumelles  
 Locksets and  
 hinges

# OPEN GLASS

## Caractéristiques techniques

- Kit de transformation d'une porte en bois par une porte en verre.
- Pour verre trempé de 8 mm
- Hauteur maxi dans la feuillure 2200 mm
- Largeur maxi dans la feuillure 1000 mm
- Pour des feuillures de 35 à 48 mm de profondeur

## Technical features

- Kit for transformation of wooden door to glass door
- Pour verre trempé de 8 mm
- Maximum height in the frame 2200 mm
- Maximum width in the frame 1000 mm
- For frames of 35 to 48 mm in depth

## LES + PRODUITS

Design  
Confort  
Simplicité  
et rapidité de pose

Design  
User comfort  
Quick and easy  
assembling

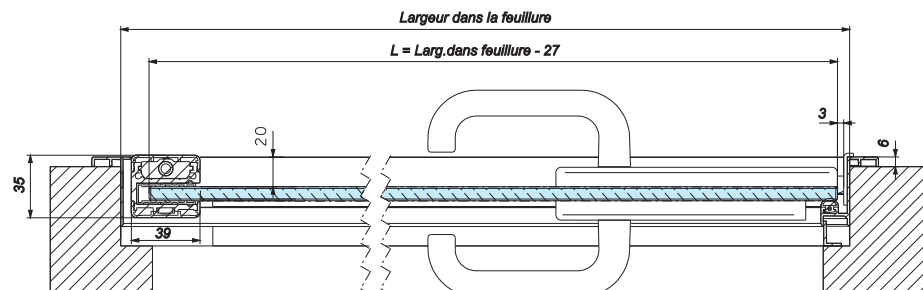
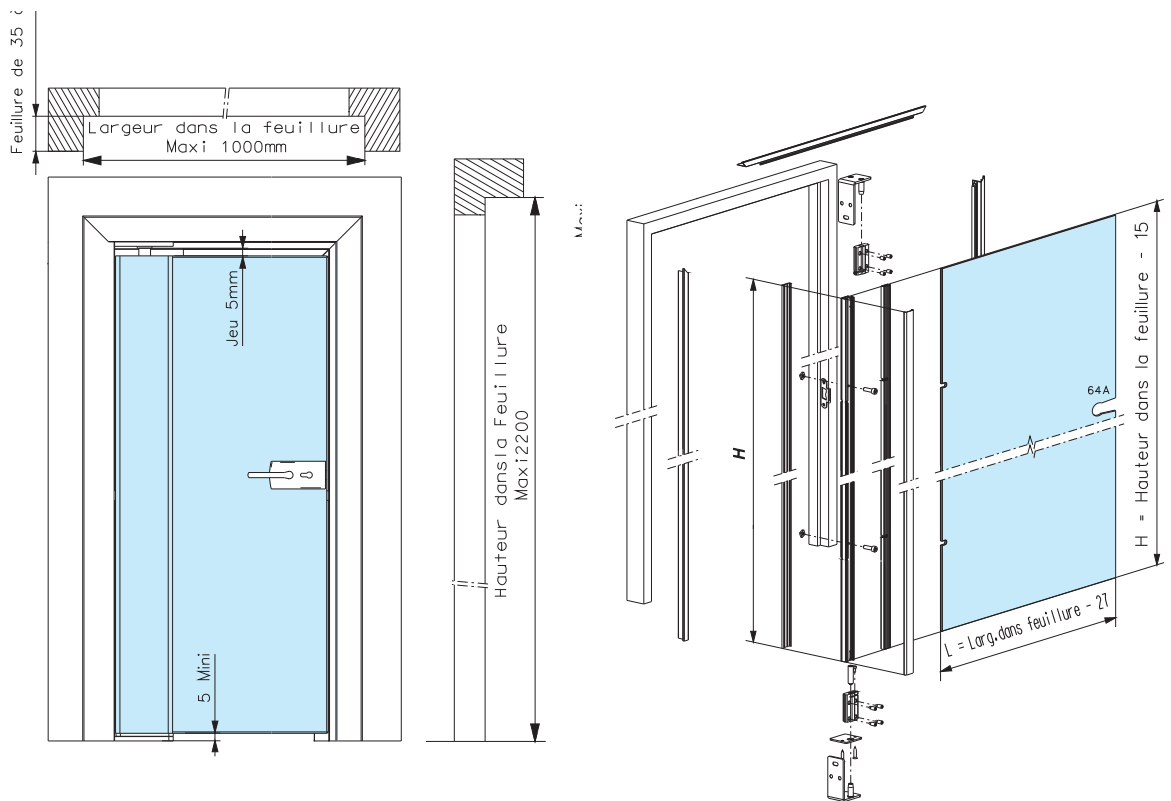

## Références / References



Kit rénovation pour porte intérieure  
Renovation kit for interior door

KPR01/08.12

KPR01/08.51



### Ce kit comprend

- 2 Profils verticaux lg 2200 mm et 1 profil horizontal lg 1000 mm pour l'habillage du bâtis.
- 5 mètres de joint périphérique
- 1 Profil articulé avec capots et pivots Haut et Bas intégrés
- Livré avec vis de fixation et gâche plate spécifique pour serrure réf : 4360.\*\*.0 et 4361.\*\*.0

### This kit includes

- 2 vertical profiles 2200 mm in length and 1 horizontal profile 1000 mm in length for the casing
- 5 metres of seal for frame
- 1 hinged profile with top and bottom integrated pivots and cover
- Delivered with fixing screws and flat strike plate compatible with the lock ref 4360.\*\*.0 and 4361.\*\*.0

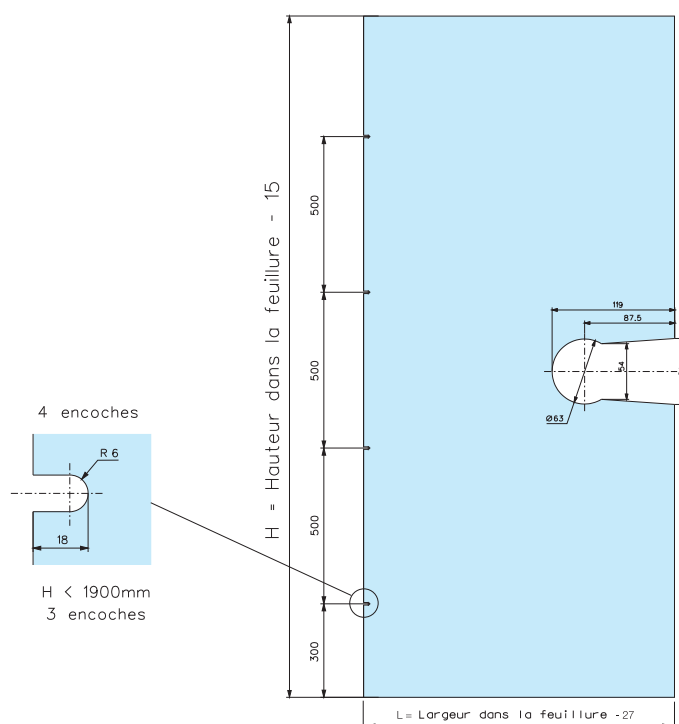

# DOORFRAME

## Caractéristiques techniques

- Pour porte en verre trempé de 8, 10 et 12 mm
- Pour panneaux fixe de 8, 10, 12 et 15 mm
- Profil permettant d'appliquer différentes charnières
- Compatible avec les serrures séries LUMIRA, LUMIRA vertical, BASTILLE, LAGUNE
- Le galet de blocage RS02 peut être installé avec une paire de poignées ou une paire de boutons
- Possibilité d'intégration d'une gâche électrique (voir chapitre contrôle d'accès)
- Permet l'intégration facile d'une porte en verre dans un ensemble Sécurit
- Utilisation des profils KL001 et KL002 recommandé pour fixation de l'ensemble

## Technical features

- For doors of 8, 10 and 12 mm. thick toughened glass
- For fixed panels of 8, 10, 12 and 15 mm
- Profile allowing several different hinges
- Compatible with lock series LUMIRA, LUMIRA vertical, BASTILLE, LAGUNE
- A blocking roller keep can be installed so handles or door knobs can be used
- Possible installation of an electric release keep (see chapter access control)
- Allows an easy integration of a glass door in a Securit set
- Use KL001 and KL002 profiles recommended to fix the frames

## LES + PRODUITS

The + product

Esthétique

Étanchéité  
acoustique

Installation facile

Elegant design

Sound proofed

Easy installation

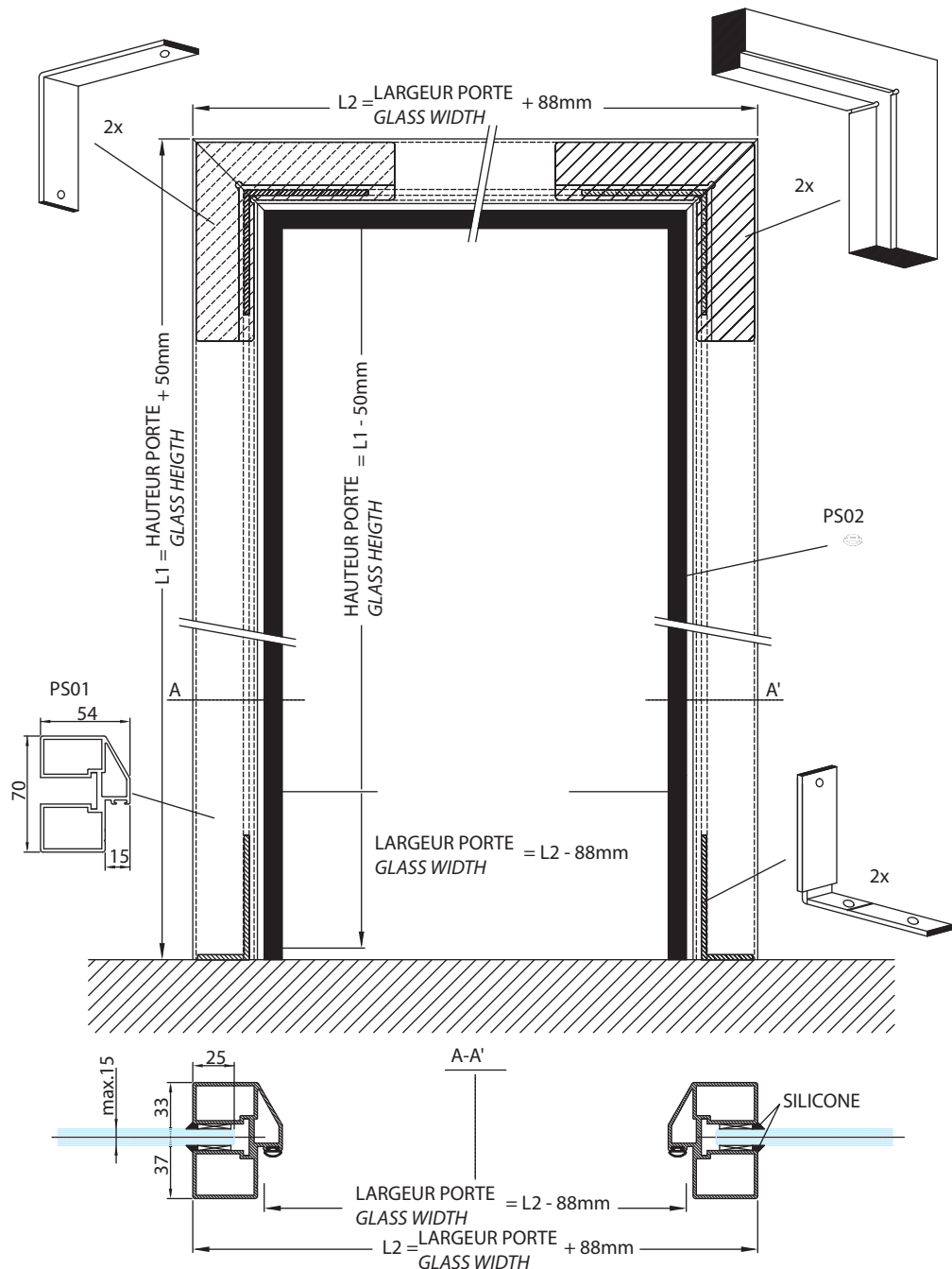



GENUINWORK

SSSSSSSTT ...  
HIER RUPT DE RUDI

## PS01MST



DIN GAUCHE / DIN LEFT

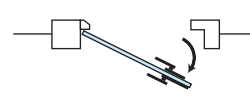

PS01MST/08L.XX

DIN DROITE / DIN RIGHT

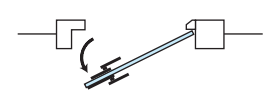

PS01MST/08R.XX

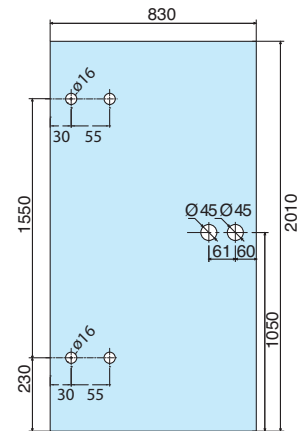

### Références / References



Kit complet profil d'encadrement porte en verre de 830 x 2010 mm avec serrure V310 + V750 et paumelles V504  
Complete Kit door frame profile for 830 x 2010 mm glass doors with lock V310 + V750 and hinges V504



Aluminium anodisé Argent Brossé  
Brushed anodised alu silver



Aluminium anodisé Aninox  
Brushed anodised alu.

DIN gauche DIN left

PS01MST/08L.12

PS01MST/08L.36

DIN droite DIN right

PS01MST/08R.12

PS01MST/08R.36

## PS

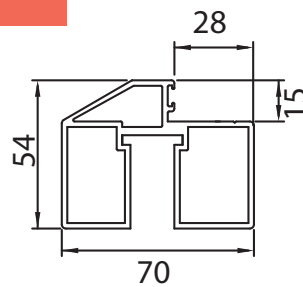

### Références / References



Profil d'encadrement vertical longueur 2500 mm  
2500 mm length profile for vertical door frame



Aluminium anodisé Argent Brossé  
Brushed anodised alu silver



Aluminium anodisé Aninox  
Brushed anodised alu.

PS2500.12

PS2500.36

Profil d'encadrement horizontal longueur 1500 mm  
1500 mm length profile for horizontal door frame

PS1500.12

PS1500.36

## PS02.99



### Références / References

Joint pour encadrement porte en verre  
Rubber strip for door frame



# PS09.99

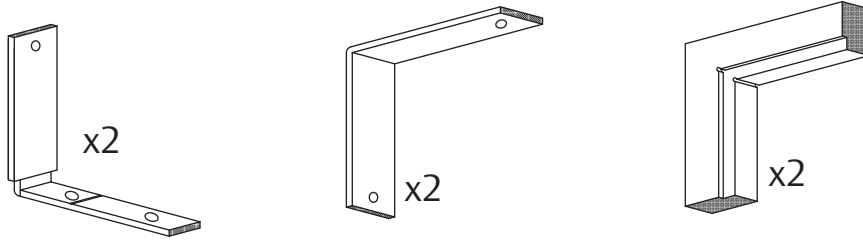

Serrures et  
paumelles  
Locksets and  
hinges

Kit de fixation d'angle pour profil encadrement PS01, vis de fixation inclus  
Corner mounting kit for doorframe profil PS01, including fixing screws

# V504

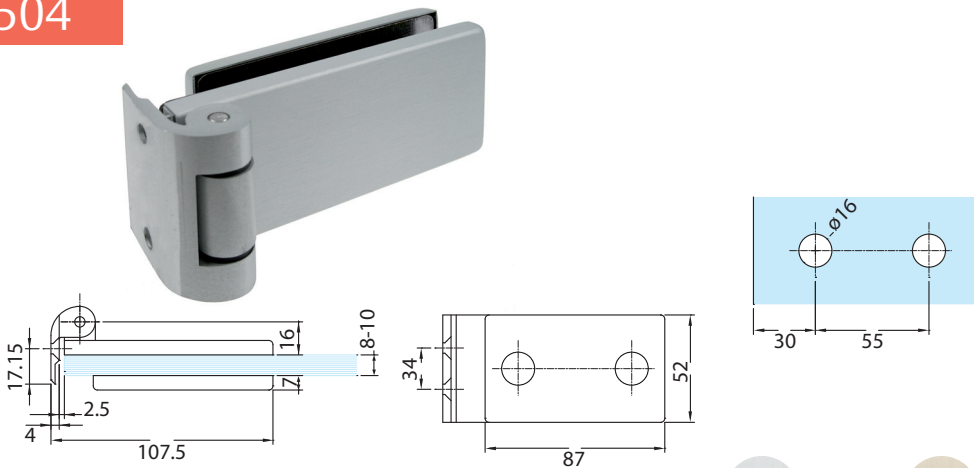

### Références / References

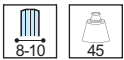

Aluminium anodisé Argent Brossé / Brushed anodised alu silver  
Aluminium anodisé Aninox / Brushed anodised alu.

Paumelle et fiche pour profil alu encadrement porte en verre PS01  
Hinge and multi rebate butt for door frame aluminium profile for glass door PS01

V504.12

V504.36

# RS02.99

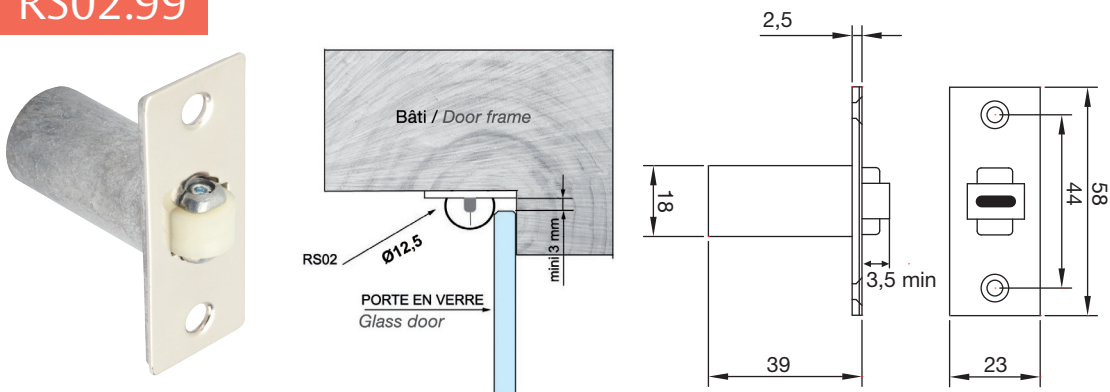

Galet avec rouleau nylon, réglable  
Blocking roller keep, adjustable

## 2800.66.4

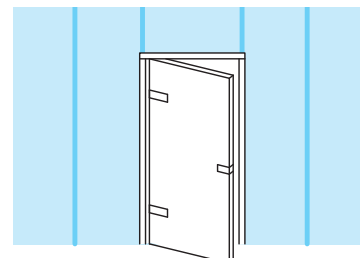
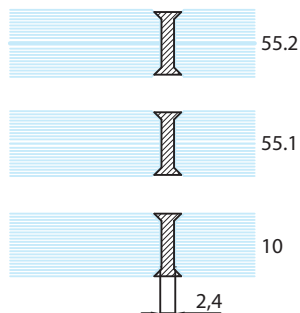
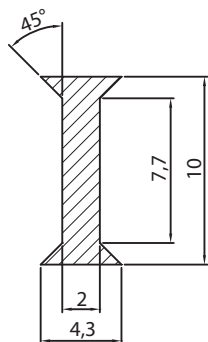

### Références / References

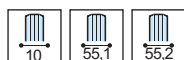

SL  
3250 mm

Joint PVC pour verre 10 mm - 55,1 - 55,2 adhésif inclus pour joindre 2 panneaux fixes  
Dry glazing profile for glass 10 mm - 55,1 - 55,2 including tape for jointing 2 fixed panels

**2800.66.4**

- Unité de vente : 1 joint conditionné par 10
- Sold in units : packed by 10

## 2800.66.5

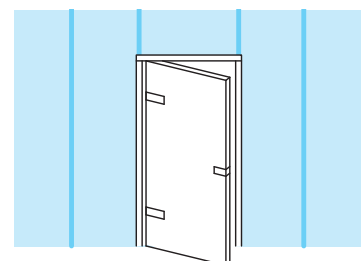
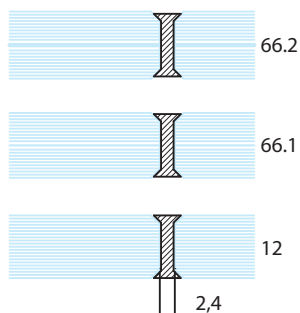
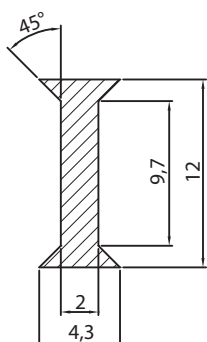

### Références / References



SL  
3250 mm

Joint PVC pour verre 12 mm - 66,1 - 66,2 adhésif inclus pour joindre 2 panneaux fixes  
Dry glazing profile for glass 12 mm - 66,1 - 66,2 including tape for jointing 2 fixed panels

**2800.66.5**

- Unité de vente : 1 joint conditionné par 10
- Sold in units : packed by 10



# Paumelles *Hinges*

## LAGUNE & LUMIRA

### Caractéristiques techniques

- Pour verre trempé de 8 à 10 mm
- Montage sur encoche 6200EF
- Dimension maximum des portes 827 mm x 2034 mm
- Poids maximum admissible 45 kg pour 2 paumelles, pour un poids supérieur pose obligatoire d'une 3ème paumelle

### Technical features

- For 8 to 10 mm thick toughened glass
- To fit notch 6200EF
- Dimensions size of doors 827 mm x 2034 mm
- Max load 45 kg for 2 hinges, for load exceeding a third hinge must be fitted



### LES + PRODUITS

Design des serrures  
Lagune et Lumira

*Lagune and Lumira  
lock design*



# 4200

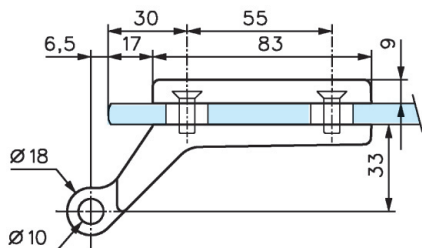
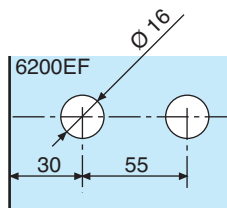

## Références / References

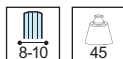

Chromé brillant  
Bright chromium



Chromé mat  
Matt chromium



Effet inox  
Stainless steel effect



Doré  
Gold plated



Laqué blanc 9010  
Lacquered white RAL 9010

Paumelle pour feuillures de 35 à 40 mm,  
s'utilise avec les fiches 3204 - 3205 - 3206  
Hinge for rebate of 35 to 40 mm, to fit  
butts 3204 - 3205 - 3206

4200.30.0

4200.31.0

4200.35.0

4200.40.0

4200.51.0

# 4201

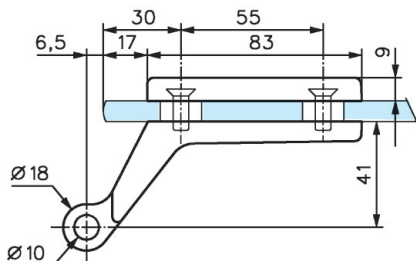
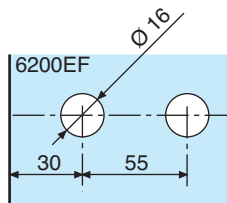

## Références / References

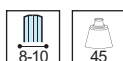

Chromé brillant  
Bright chromium



Chromé mat  
Matt chromium



Effet inox  
Brushed stainless steel



Doré  
Gold plated



Laqué blanc 9010  
Lacquered white RAL 9010

Paumelle pour feuillures supérieures  
à 40 mm, s'utilise avec les fiches  
3204 - 3205 - 3206  
Hinge for rebate larger than 40 mm,  
to fit butts 3204 - 3205 - 3206

4201.30.0

4201.31.0

4201.35.0

4201.40.0

4201.51.0

Serrures et paumelles  
Locksets and hinges

4203

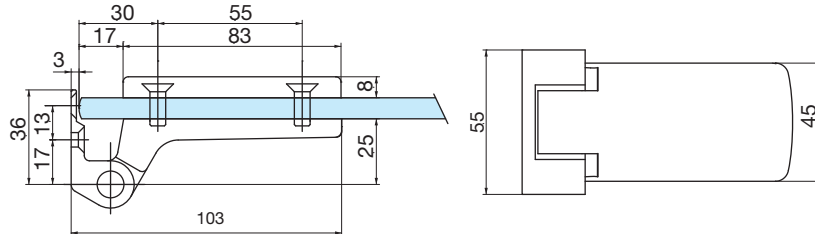
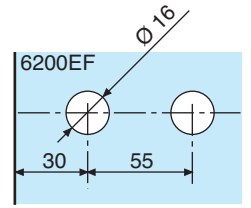

Références / References



Chromé brillant  
Bright chromium



Chromé mat  
Matt chromium



Effet inox  
Stainless steel effect



Doré  
Gold plated



Laqué blanc 9010  
Lacquered white RAL 9010

Paumelle et fiche multi feuillure pour tous types d'huisseries  
Hinge and multi rebate butt for all types of frame

4203.30.0

4203.31.0

4203.35.0

4203.40.0

4203.51.0

LES + PRODUITS

Montage facile  
Tout support

Easy installation  
Fits to all kinds of frame

V504

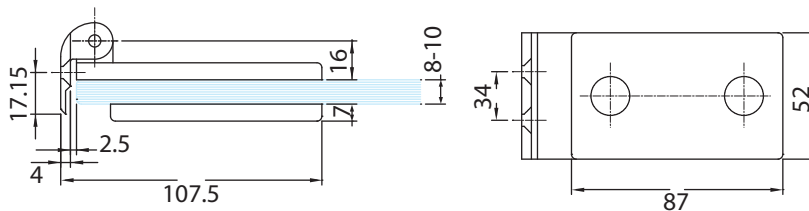
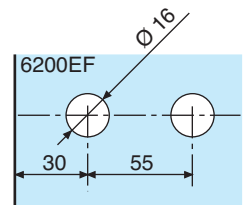

Références / References



Aluminium anodisé Argent Brossé  
Brushed anodised alu silver



Aluminium anodisé Aninox  
Brushed anodised alu.

Paumelle et fiche pour profil alu encadrement porte en verre PS01  
Hinge and multi rebate butt for door frame profile for glass door PS01

V504.12

V504.36

# V505

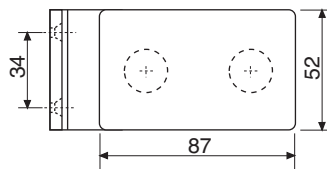
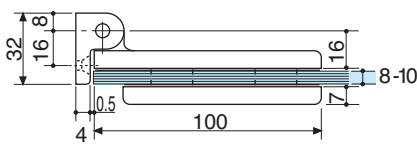
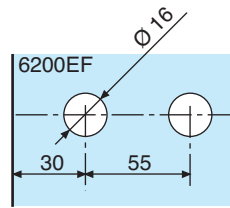

## Références / References

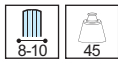

Laiton poli verni  
Polished varnished brass



Aluminium anodisé Argent Brossé  
Brushed anodised alu silver



Chromé brillant  
Bright chromium



Chromé mat brossé  
Brushed matt chromium



Aluminium anodisé Aninox  
Brushed anodised alu.

Paumelle et fiche multi feuillure  
pour tous types d'huisseries  
Hinge and multi rebate butt for all  
types of frame

V505.01

V505.12

V505.30.0

V505.33

V505.36

# V507

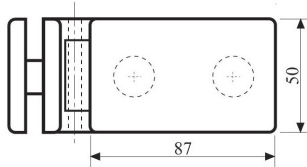
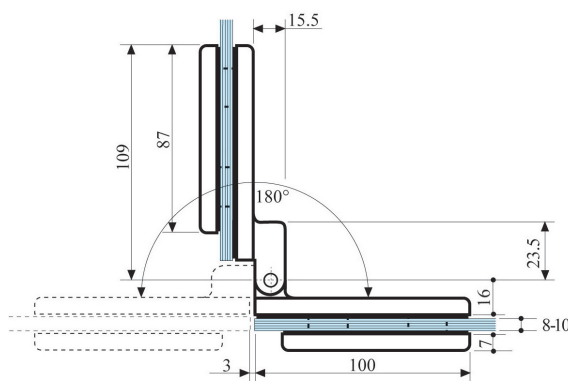
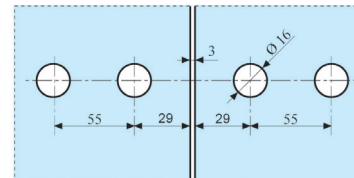
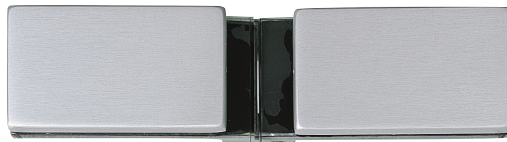

## Références / References



Laiton poli verni  
Polished varnished brass



Aluminium anodisé Argent Brossé  
Brushed anodised alu silver



Chromé brillant  
Bright chromium



Chromé mat brossé  
Brushed matt chromium



Aluminium anodisé Aninox  
Brushed anodised alu.

Paumelle double verre/verre pour portes simple action  
Glass to glass hinge for single action doors

V507.01

V507.12

V507.30.0

V507.33

V507.36

3204

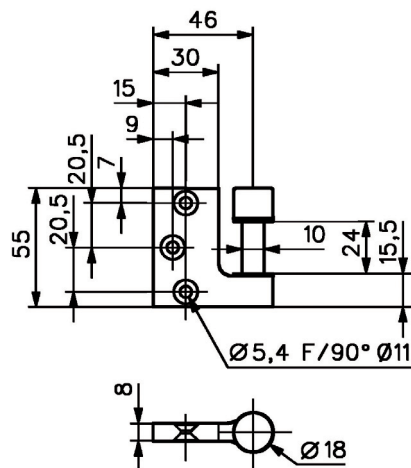

Chromé brillant  
Bright chromium



Chromé mat  
Matt chromium



Doré  
Gold plated



Laqué blanc 9010  
Lacquered white RAL 9010

Références / References

Fiche à entailler réversible pour huisseries bois,  
s'utilise avec les paumelles 4200 et 4201  
Reversible flush fixed butt for wooden door frame,  
to fit to hinges 4200 and 4201

3204.30.0

3204.31.0

3204.40.0

3204.51.0

3206.\*\*.0

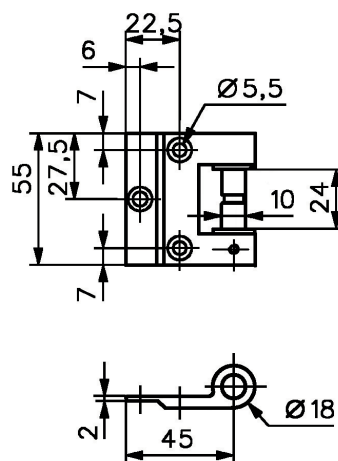

Références / References

Fiche en applique réversible pour toutes huisseries bois, métalliques et aluminium, s'utilise avec les paumelles 4200 et 4201  
Reversible surface fixed butt for all types of wooden, metal and aluminium frame, to fit to hinges 4200 and 4201



Laiton poli  
Polished brass



Chromé brillant  
Bright chromium



Chromé mat  
Matt chromium



Effet inox  
Stainless steel effect



Doré  
Gold plated



Laqué blanc 9010  
Lacquered white RAL 9010

3206.00.0

3206.30.0

3206.31.0

3206.35.0

3206.40.0

3206.51.0



3205.\*\*.1

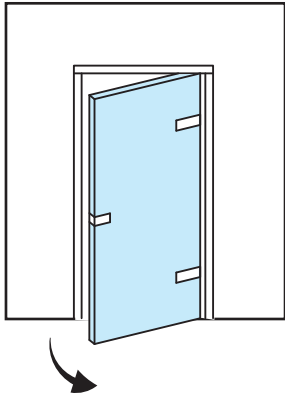
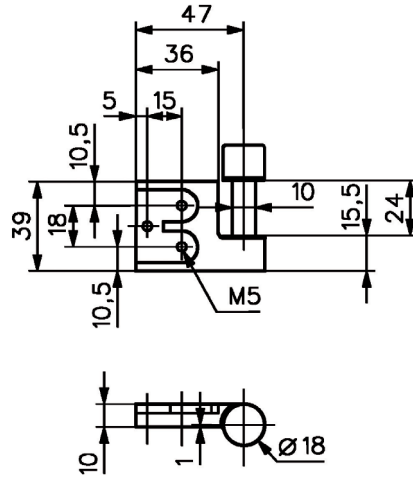

Références / References

Fiche à entailler (main droite) non réversible pour huisseries métalliques, s'utilise avec les paumelles 4200 et 4201

*Non reversible mortised butt (right hand) for metal frame, to fit hinges 4200 and 4201*



Chromé mat  
Matt chromium

3205.31.1

3205.\*\*.2

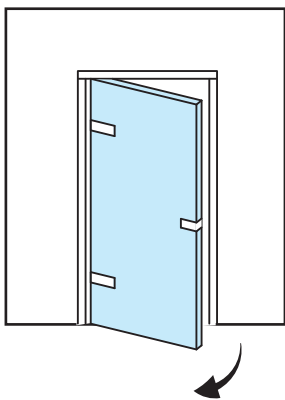
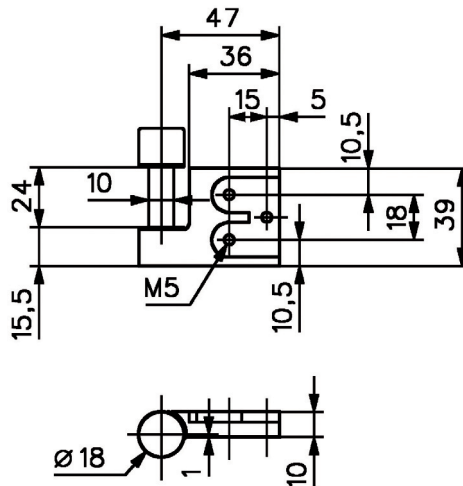

Références / References

Fiche à entailler (main gauche) non réversible pour huisseries métalliques, s'utilise avec les paumelles 4200 et 4201

*Non reversible mortised butt (left hand) for metal frame, to fit hinges 4200 and 4201*



Chromé mat  
Matt chromium

3205.31.2

# Paumelles *Hinges*

## BASTILLE

### Caractéristiques techniques

- Pour verre trempé de 8, 10 et 12 mm
- Montage sur encoche 6202EX
- Poids maximum admissible 45 kg pour 2 paumelles, largeur maximum 1000 mm, pour un poids supérieur nous consulter

### Technical features

- For 8, 10 and 12 mm thick toughened glass
- To fit notch 6202EX
- Max load 45 kg, maximum width 1000 mm, for 2 hinges please consult us for glass weighting more than 45 kg



### LES + PRODUITS

Montage facile  
Tout support

Easy installation  
Fit to all kind of frame

4202

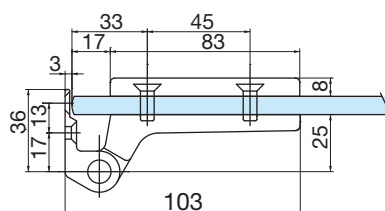
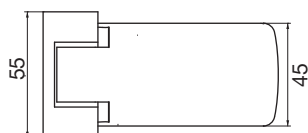
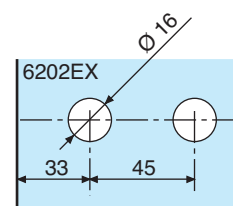

### Références / References

Paumelle et fiche multi feuillure  
pour tous types d'huissieries  
*Hinge and multi rebate butt for all  
types of frame*



Laiton poli PVD  
Polished brass PVD



Chromé brillant  
Bright chromium



Chromé mat  
Matt chromium



Effet inox  
Stainless steel effect



4202.05.0

4202.30.0

4202.31.0

4202.35.0



4202.31.5

4202.35.5

4206

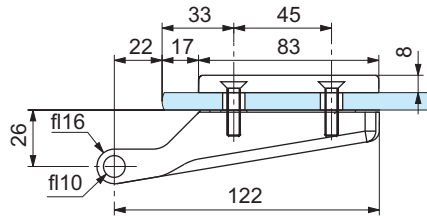
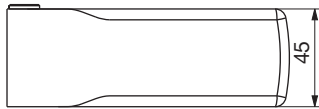
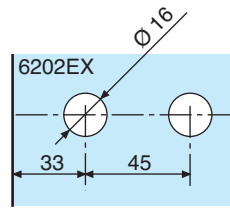

Références / References



Chromé brillant  
Bright chromium

4206.30.0



Chromé mat  
Matt chromium

4206.31.0



Effet inox  
Stainless steel effect

4206.35.0

Paumelle pour feuillure de 24 mm,  
s'utilise avec les fiches 4207 - 4208 - 4209  
Hinge for rebate of 24 mm, to fit butts  
4207 - 4208 - 4209

V505.2

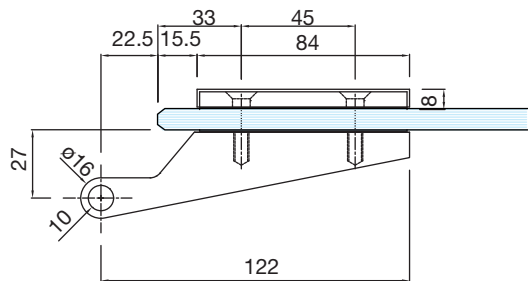
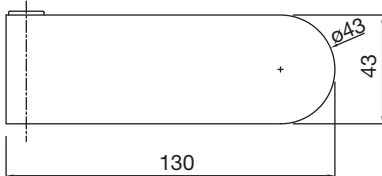
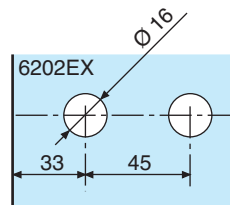

Références / References



Aluminium anodisé Argent Brossé  
Brushed anodised alu silver

V505.2.12



Aluminium anodisé Aninox  
Brushed anodised alu.

V505.2.36

Paumelle pour feuillure de 24 mm, s'utilise  
avec les fiches 4207 - 4208 - 4209  
Hinge for rebate of 24 mm, to fit butts  
4207 - 4208 - 4209

4208.99.0

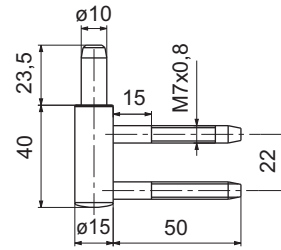
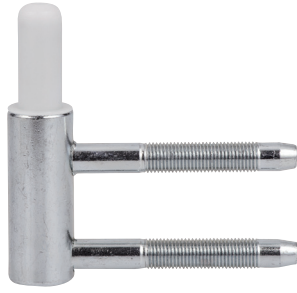

Fiche pour huisseries bois, s'utilise avec la paumelle 4206 et caches fiches 4205  
Butt for wooden door frame, to fit hinge 4206 and butt covers 4205

4209.99.0

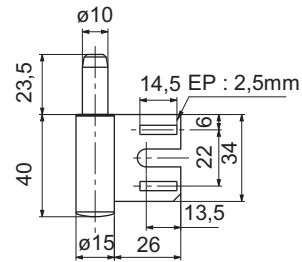

Fiche pour huisseries métalliques, s'utilise avec la paumelle 4206 et caches fiches 4205  
Butt for metal door frame, to fit hinge 4206 and butt covers 4205

K3172.99

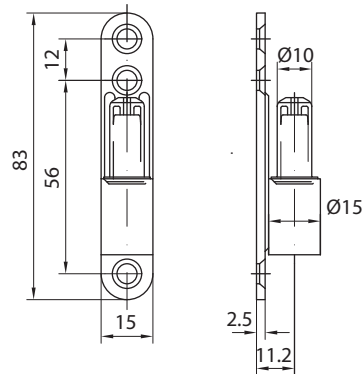

Fiche en applique réversible pour toutes huisseries bois, métalliques et aluminium, s'utilise avec les paumelles 4206 - V505.2 et caches fiches 4205 - V207  
Reversible surface fixed butt for all types of wooden, metal and aluminium frame, to fit hinges 4206 - V505.2 and butt covers 4205 - V207

4205

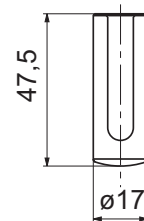

Références / References

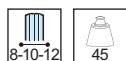

Chromé brillant  
Bright chromium



Chromé mat  
Matt chromium



Effet inox  
Stainless steel effect

Caches pour fiches 4207 - 4208 - 4209  
Covers for butt 4207 - 4208 - 4209

4205.30.0

4205.31.0

4205.35.0

## LUMIRA VERTICALE

### Caractéristiques techniques

- Pour verre trempé de 8 et 10 mm
- Montage sur encoche V380E
- Poids maximum admissible 45 kg pour 2 paumelles, largeur maximum 1000 mm, pour un poids supérieur nous consulter

### Technical features

- For 8 and 10 mm thick toughened glass
- To fit notch V380E
- Max load 45 kg, maximum width 1000 mm, for 2 hinges please contact us for glass weighing more than 45 kg

V381

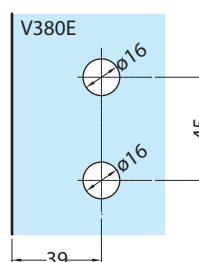
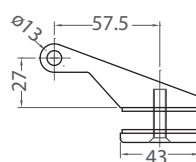
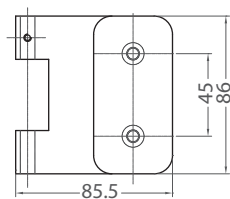

### Références / References

Paumelle et fiche pour feuillure de 35 mm  
Hinge and butt for rebate of 35 mm

Aluminium anodisé Argent Brossé  
Brushed anodised alu silver

V381.12

Inox Brossé  
Brushed stainless steel

V381.15

Serrures et  
paumelles  
*Locksets and  
hinges*

# SWINGO

## Caractéristiques techniques

- Blocage à 90°
- Pour verre trempé de 8 et 10 mm
- Poids maximum admissible 60 kg pour 2 charnières
- Largeur maximum de la porte 900 mm
- Montage sur encoche V861E
- Livrée avec joints et vis de fixation
- Réglage possible du point 0 pour le 4861

## Technical features

- Blocking points at 90°
- For 8 and 10 mm thick toughened glass
- Max load 60 kg for 2 hinges
- Width of the door 900 mm
- Assembly on notch V861E
- Delivered with spacers and fixing screws

## LES + PRODUITS

*The + product*

Design

Fermeture  
automatique  
de la porte

Installation facile  
et discrète

*Elegant design*

*Automatic door closing*

*Easy and discreet  
installation*



4861

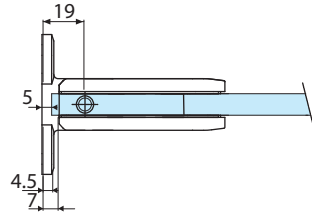
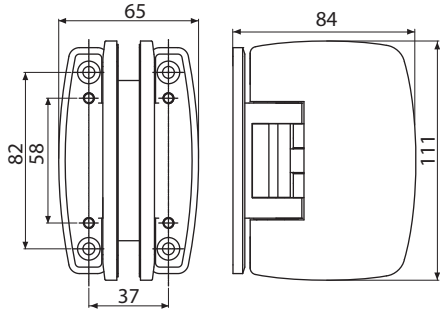
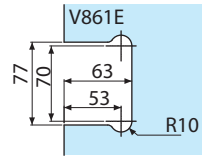

Références / References



Chromé brillant  
Bright chromium



Chromé mat  
Matt chromium



Effet inox  
Stainless steel effect

Charnière simple mur/verre à rappel automatique  
Single hinge wall/glass automatic return

4861.30.0

4861.31.0

4861.35.0

4862

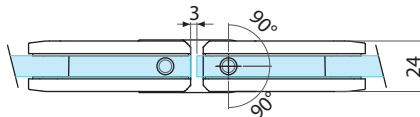
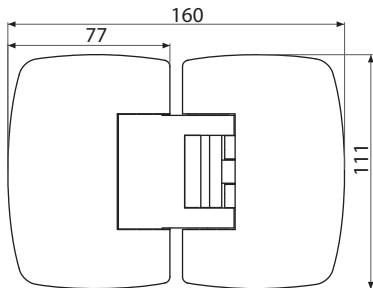
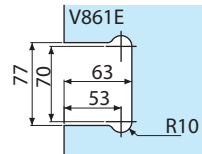

Références / References



Chromé brillant  
Bright chromium



Chromé mat  
Matt chromium



Effet inox  
Stainless steel effect

Charnière double verre/verre à rappel automatique  
Glass to glass automatic return hinge

4862.30.0

4862.31.0

4862.35.0

# Pentures *Hinges* LUMIRA

## Caractéristiques techniques

- Pour verre trempé épaisseur 8, 10 et 12 mm
- Poids maximum admissible 75 kg
- Dimensions maxi pour portes en verre 900 x 2200 mm
- Montage sur encoche V590E

## Technical features

- For 8, 10 and 12 mm thick toughened glass
- Max load 75 kg
- Maximum size for glass doors 900 x 2200 mm
- Assembly on notch V590E

V590



## LES + PRODUITS

The + product

Idéal pour portes  
lourdes ou  
grand format

Ideal for heavy and  
large doors

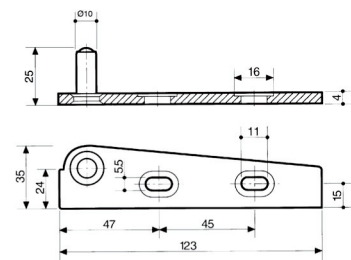
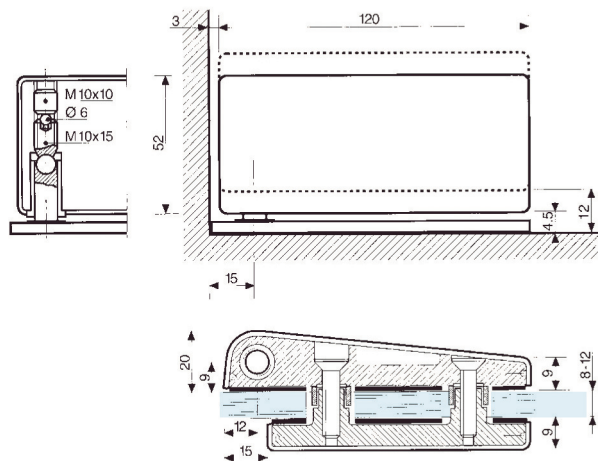
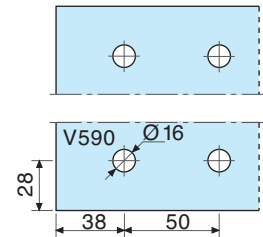
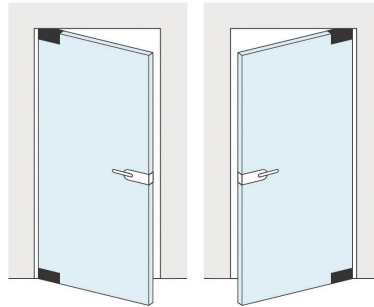
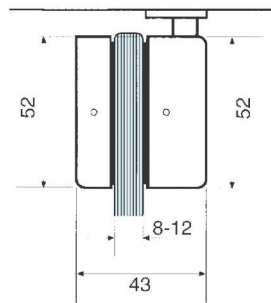

## Références / References

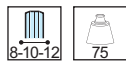

Laiton poli verni  
Polished varnished brass



Aluminium anodisé Argent Brossé  
Brushed anodised alu silver



Chromé brillant  
Bright chromium



Chromé mat brossé  
Brushed matt chromium



Aluminium anodisé Aninox  
Brushed anodised alu.

Pentures déportées basse et  
haute avec platines

Top and bottom offset pivot  
hinges with mounting plate

V590.01

V590.12

V590.30

V590.33

V590.36



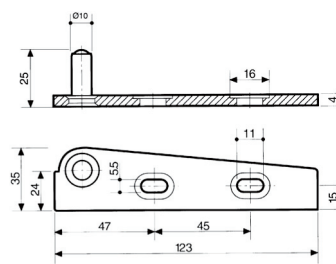
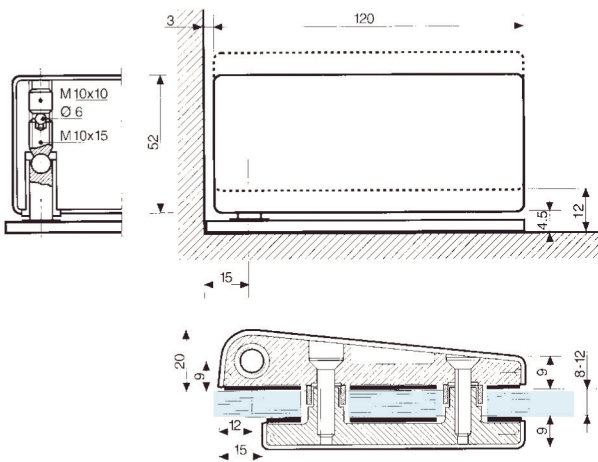
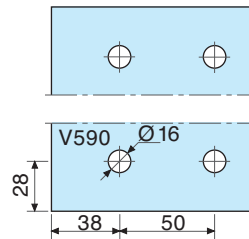
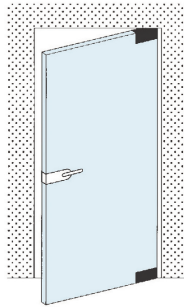
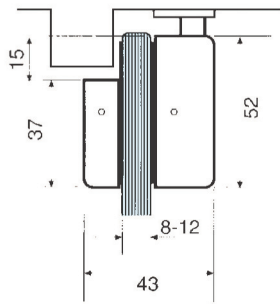

Références / References

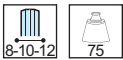

Laiton poli verni  
Polished varnished brass

V592.01



Aluminium anodisé Argent Brossé  
Brushed anodised alu silver

V592.12



Chromé brillant  
Bright chromium

V592.30



Chromé mat brossé  
Brushed matt chromium

V592.33



Aluminium anodisé Aninox  
Brushed anodised alu.

V592.36

Pentures déportées basse et haute avec platines, penture supérieure raccourcie

Top and bottom offset pivot hinges with mounting plate, top hinge with reduced



LES + PRODUITS

The + product

Idéal pour portes  
lourdes ou grand  
format

Ideal for large and  
heavy doors

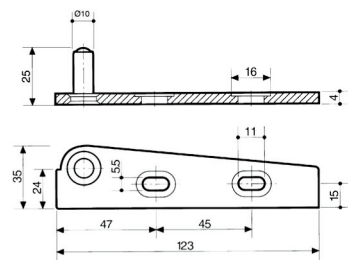
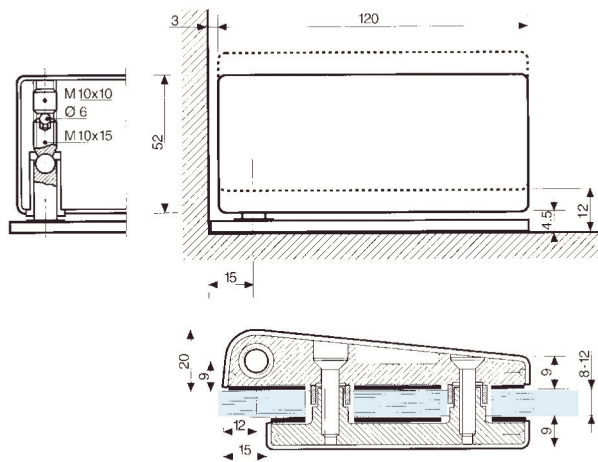
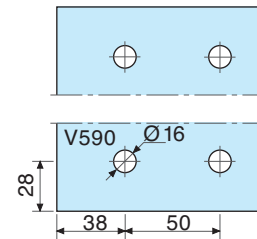
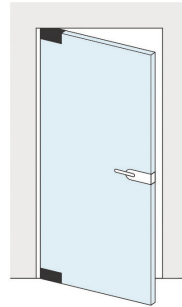
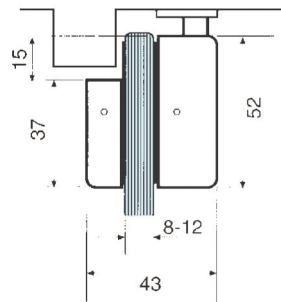

Références / References

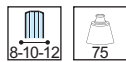

Laiton poli verni  
Polished varnished brass



Aluminium anodisé Argent Brossé  
Brushed anodised alu silver



Chromé brillant  
Bright chromium



Chromé mat brossé  
Brushed matt chromium



Aluminium anodisé Aninox  
Brushed anodised alu.

Pentures déportées basse et  
haute avec platines, penture  
supérieure raccourcie

Top and bottom offset pivot  
hinges with mounting plate, top  
hinge with adapted back plate

V593.01

V593.12

V593.30

V593.33

V593.36



Idéal pour portes  
lourdes ou grand format  
*Ideal for large and heavy doors*

Image d'illustration

V090.15

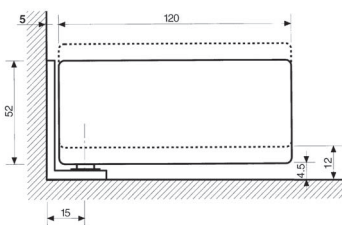
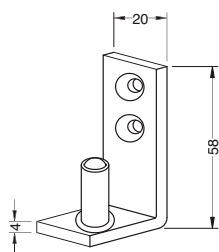

#### Références / References

Platine pour V590, V592, V593 pour montage sur bâti uniquement  
*Plate for V590, V592, V593 for support mounting only*

# LOQUETEAUX

## Caractéristiques techniques

- Ne nécessite aucune encoche, sauf réf V529 et V539
- Se pose sur le chant du verre, jeu minimum 4 mm
- Blocage du pêne en position sortie ou rentrée
- Pour verre trempé de 8, 10 et 12 mm
- Livrée avec gâche plate (2 clés pour réf 1448)

## Technical features

- Requires no notch, except ref V529 and V539
- Fixing on edge of door, minimum space 4 mm
- Bolt can be blocked in the projecting or retracted position
- For 8, 10 and 12 mm thick toughened glass
- Supplied with flat keep (2 keys for ref 1448)

1445

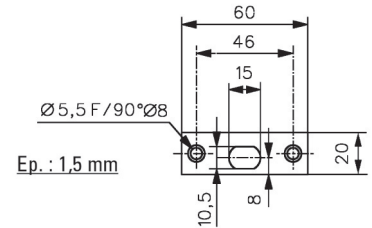
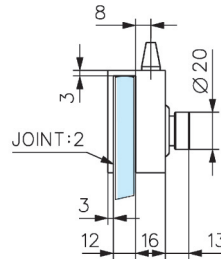
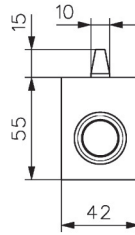

## Références / References



Loqueteau à bouton  
Clip on lock with notch



Laiton poli  
Polished brass

1445.00.0



Chromé brillant  
Bright chromium

1445.30.0



Chromé mat  
Matt chromium

1445.31.0

## LES + PRODUITS

The + product

Idéal pour portes  
semi-fixe

Ideal for semi-fixed  
doors

1446

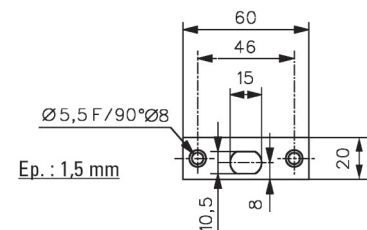
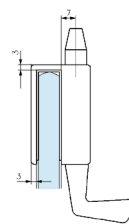
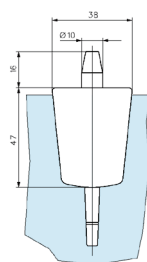

## Références / References

Loqueteau à tirage  
Clip on lock with  
pull catch



Laiton poli PVD  
Polished brass PVD

1446.05.0



Chromé brillant  
Bright chromium

1446.30.0



Chromé mat  
Matt chromium

1446.31.0



Effet inox  
Stainless steel effect

1446.35.0



Laqué Blanc  
Lacquered white RAL 9010

1446.51.0



1446.30.5

1446.31.5

1448

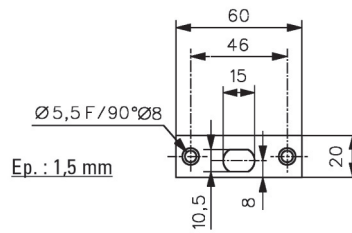
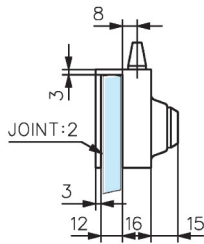
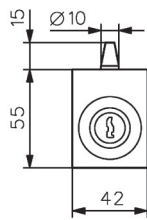

Références / References



Loqueteau à clé  
Clip on lock with cylinder



Laiton poli  
Polished brass



Chromé brillant  
Bright chromium



Chromé mat  
Matt chromium

1448.00.0

1448.30.0

1448.31.0

1447

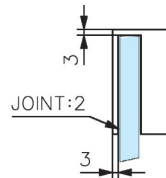

Références / References



Boîtier gâche pour loqueteaux série 1445/1448  
Matching patch keep for clip on lock series 1445/1448



Laiton poli  
Polished brass



Chromé brillant  
Bright chromium



Chromé mat  
Matt chromium

1447.00.0

1447.30.0

1447.31.0

1449

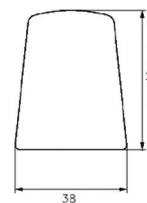
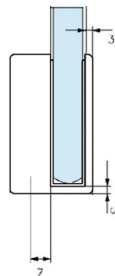

Références / References



Boîtier gâche pour  
loqueteaux série 1446  
Matching patch keep for  
clip on lock series 1446



Laiton poli PVD  
Polished brass PVD



Chromé brillant  
Bright chromium



Chromé mat  
Matt chromium



Effet inox  
Stainless steel effect



Laqué Blanc  
Lacquered white RAL 9010

1449.05.0

1449.30.0

1449.31.0

1449.35.0

1449.51.0

