

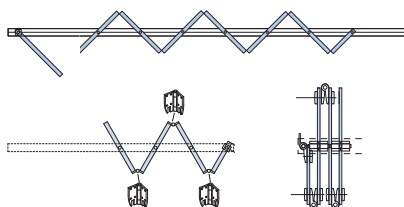

Scorrevoli a soffietto

Senza guida a terra.
Centre folding sliding systems without floor rail.
Falt-Schiebewandsysteme mit mittiger Faltung ohne Bodenführung.
pag. 276



PA-260 / PA-460
PA-560 / L-2500

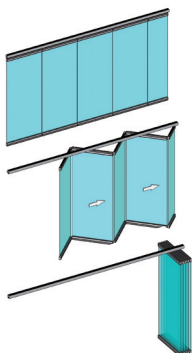

Sistemi Balconglas

Con canalina a terra, senza baia di parcheggio.
Balconglas systems with guide channel and without parking bay.
System Balconglas mit Bodenführung und ohne Parkraum.
pag. 294



BG-35 / BG-25

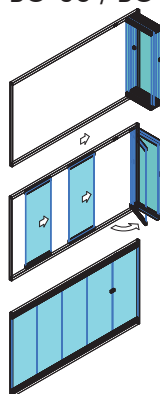

Scorrevoli a parcheggio

Con baia di parcheggio e senza guida a terra.
 Sliding stacking systems with parking bay and without bottom guide channel.
 Ganzglas-Schiebewandsysteme mit Parkraum und ohne Bodenführung.



SCORREVOLI A PARCHEGGIO
 SLIDING STACKING SYSTEMS

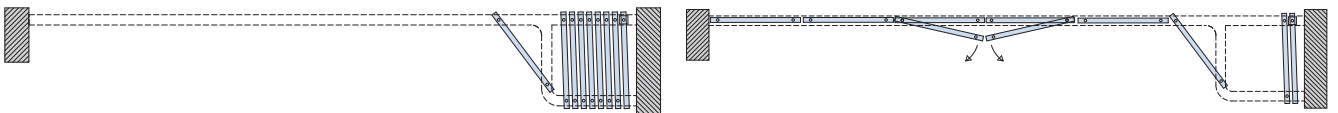

PA-200 Park line 1

(pag. 238)

Sistema scorrevole a parcheggio fornito con profili fermavetro a misure richiesta dal cliente, senza necessità di fori nel vetro.

Sliding stacking system with glass fixing profiles made to measure upon client's request, no need to make holes in the glass.

Schiebesystem mit Parkraum, kundenspezifische Glasleistenprofile ohne Glasbohrungen.

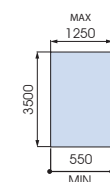
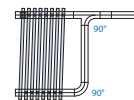
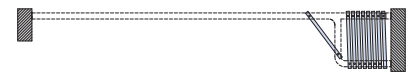
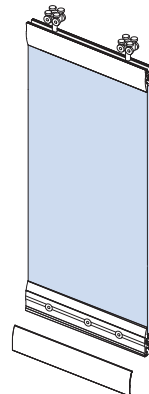
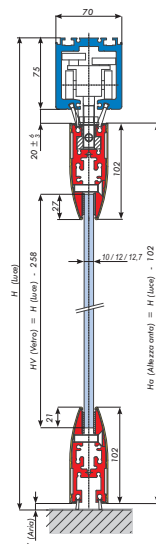

150 Kg
 110 Kg
 Porta laterale
 Lateral door
 Dreh - entflügel

PA-300 Park line 2

(pag. 242)

Sistema scorrevole a parcheggio con profili fermavetro a misure richieste dal cliente, senza fori nel vetro e con possibilità di porta centrale a battente e parcheggiabile.

Sliding stacking system with glass fixing profiles made to measure upon client's request, no need to make holes in the glass and with the possibility of hinged and parkable central panel.

Schiebesystem mit Parkraum, mit kundenspezifischen Glasleistenprofile, mit zentraler Drehtür und Parkmöglichkeit.

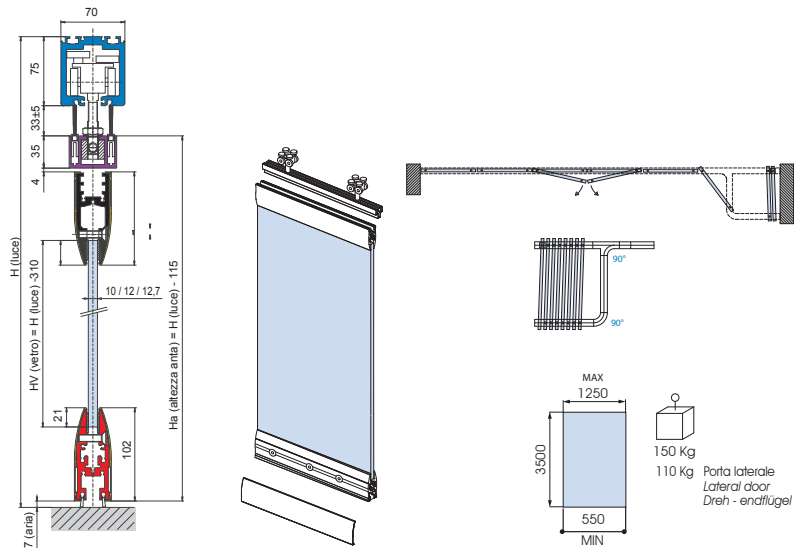

PA-400 Park do-it-yourself

(pag. 246)

Sistema scorrevole modulare a parcheggio con morsetti fermavetro (mm 250) e veletta continua (mm 1200) da tagliare secondo necessità a cura del cliente. Vantaggi di una consegna più veloce e di un unico prodotto a magazzino per tutte le misure fino a 1200 mm.

Modular sliding stacking system with glass fixing clamps (mm 250) and continuous covers (mm 1200) to be cut on the basis of client's requirements. The advantage of this product is quick delivery and a unique product available in the warehouse for all sizes up to 1200 mm.

Modulares Schiebesystem mit Parkraum, Glashalteklammern (250 mm) mit kontinuierlicher Verkleidung (mm 1200) kundenspezifisch ablangbar. Vorteile einer raschen Lieferung und eines einzigen lagermäßigen Produktes mit Abmessungen bis 1200 mm.

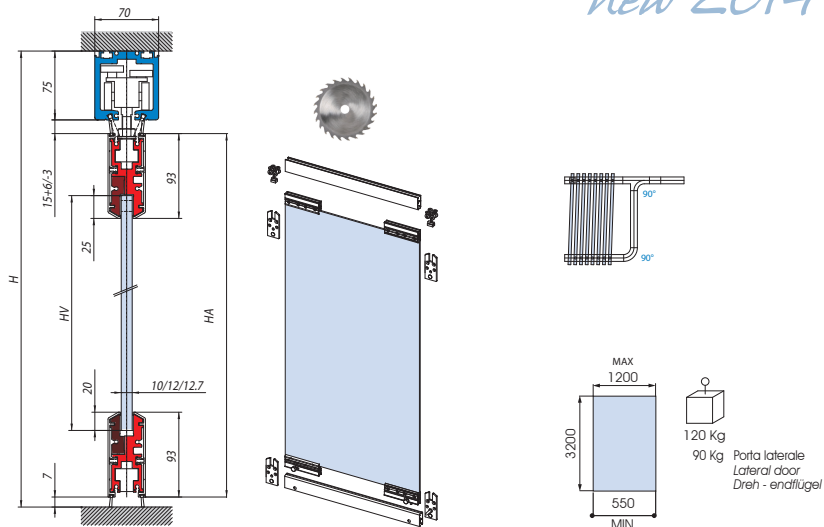

new 2014

PA-500 Park do-it-yourself

(pag. 250)

Sistema scorrevole a parcheggio con profili fermavetro continui a misura standard (mm 1200) da tagliare secondo necessità a cura del cliente, completi di catenaccioli fermaanta a posizionamento esterno regolabile. Vantaggi di una consegna più veloce e di un unico prodotto a magazzino per tutte le misure fino a 1200 mm.

Modular sliding stacking system with continuous glass fixing profiles of a standard size (mm 1200) to be cut on the basis of client's requirements comes equipped with an adjustable door holding latch positioned externally. The advantage of this product is quick delivery and a unique product available in the warehouse for all sizes up to 1200 mm.

Schiebesystem mit Parkraum, durchgehenden Laufschiene-Profilen in Standardgröße (1200 mm), ablangbar, komplett mit äußeren einstellbaren Riegeln zur Flügelbefestigung.

Vorteile einer raschen Lieferung und eines einzigen lagermäßigen Produktes mit Abmessungen bis 1200 mm.

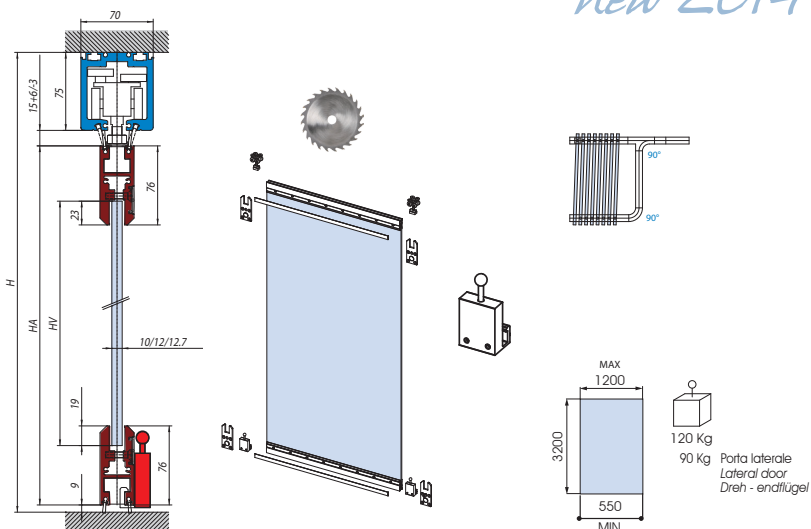

new 2014

PA-200 Park line 1

Sistema scorrevole a parcheggio fornito con profili fermavetro a misure richiesta dal cliente, senza necessità di fori nel vetro.

Sliding stacking system with glass fixing profiles made to measure upon client's request, no need to make holes in the glass.

Schiebesystem mit Parkraum, kundenspezifische Laufschiene-Profile ohne Glasbohrungen.



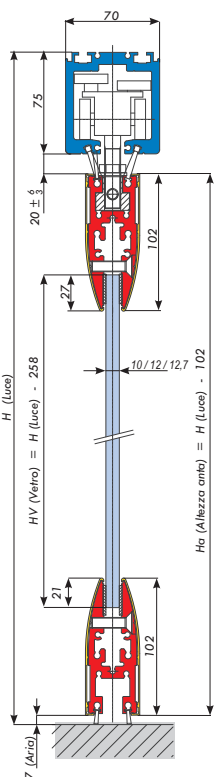

$HV = H - 258$

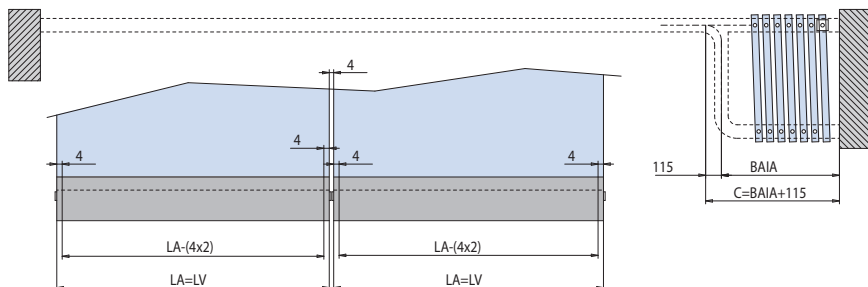

NB: C < L porta laterale
Lateral door
Dreh - endflügel

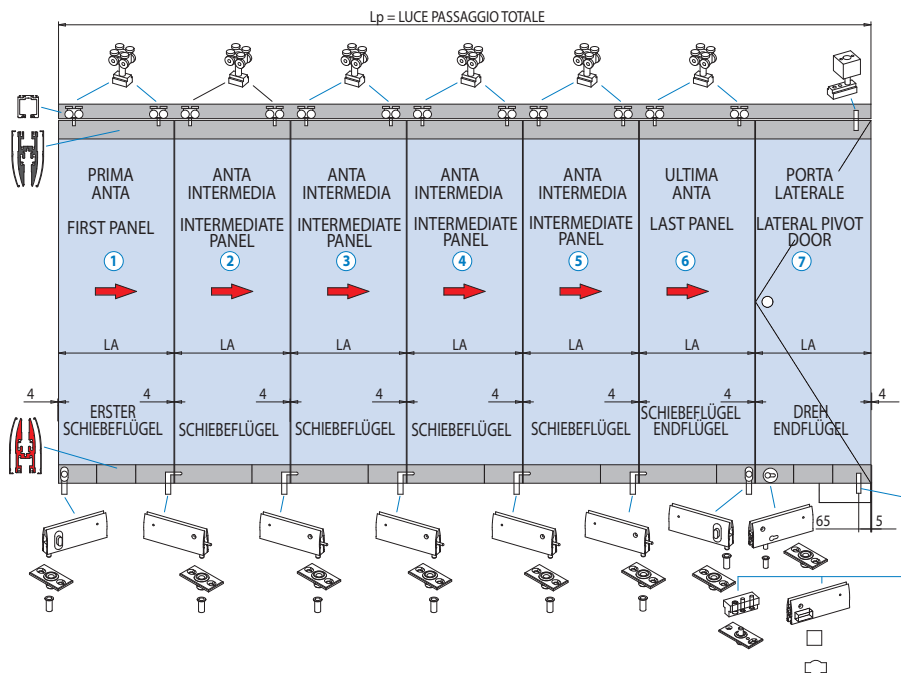
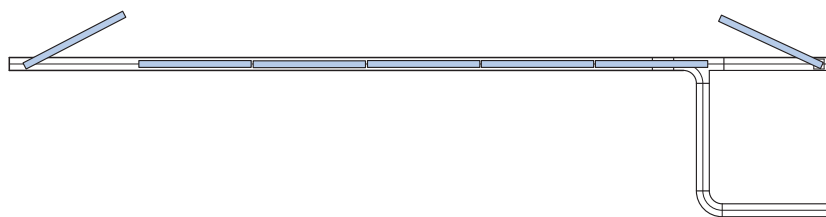

Calcolo vetro - Calculation glass - Glasberechnungen
 $At = 4 \times (N + 1)$
 $X = [\text{Luca larghezza totale (Lp)} - \text{Arie totali (At)}]$
 $X = N \times LA$
 $LA = LV / N$

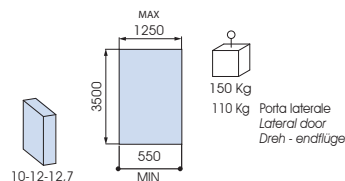

Componenti pag. 240
Components from page 240
Einzelteile Seite 240

xla 168

AN = Alluminio anodizzato
Aluminium anodized
Aluminium Silberfarbig

At = Arie totali
Total clearances
Summe alle Abstände Glas/Wand
N = Numero ante
Numbers panels
Anzahl der Elemente

Lp = Luce larghezza passaggio totale
Clear opening width
Lichte Durchgangsbreite
LA = LV Larghezza ante = Larghezza vetro
Panel width = Glass width
Flügelbreite = Glasbreite

H = Altezza passaggio luce
Clear opening height
Lichte Durchgangshöhe
HV = Altezza vetro
Glass height
Glashöhe

PA-200 Park line 1

Componenti
Components
Einzelteile

PA-108

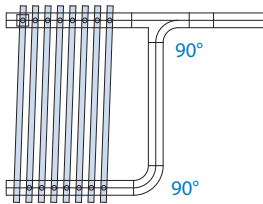

PA-109

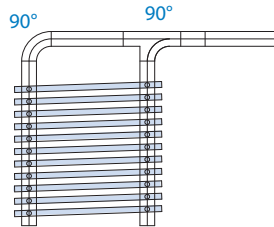

PA-100

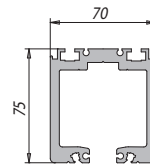

PA-113

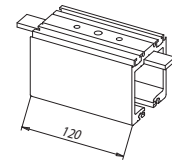

Da ordinare a parte oltre alle ante
To be ordered separately from the panels
Neben den Flügeln extra zu bestellen

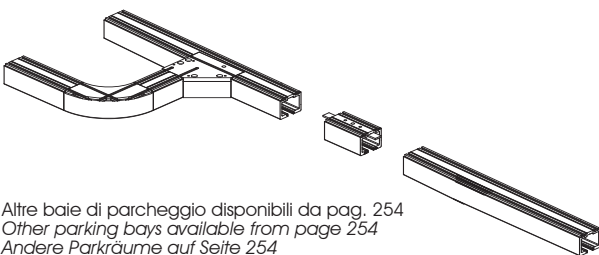

Altre baie di parcheggio disponibili da pag. 254
Other parking bays available from page 254
Andere Parkräume auf Seite 254

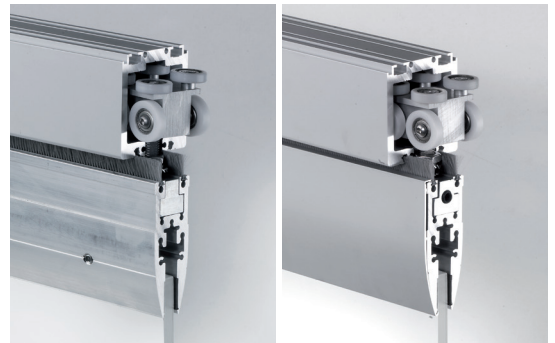

PA-201

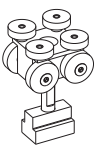

PA-205

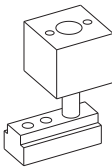

PA-206

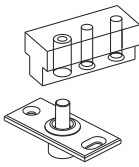

PA-215

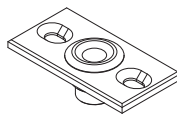

L-112-PA

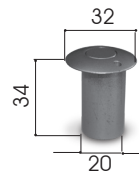

PA-211



PA-212



PA-202

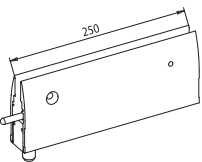

PA-203

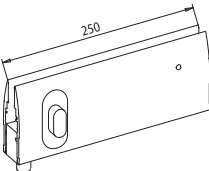

PA-204

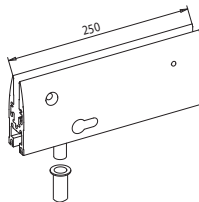

PA-207

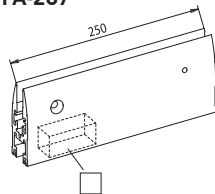

PA-208

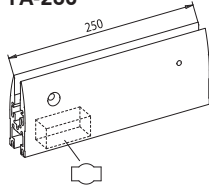

PA-209

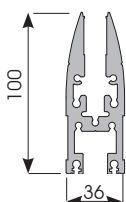

PA-210



xla 333

Certificato test sistemi a parcheggio

Test certificates sliding stacking systems
 Prüfbericht Glasschiebewandsysteme



METALGLAS BONOMI SRL

**ANALISI TECNICA DEI SISTEMI PER ANTE IN VETRO :
 CALCOLI STRUTTURALI PER RESISTENZA AL VENTO**

Pareti scorrevoli a parcheggio: PARK LINE 1 - PA-200
 Pareti scorrevoli a parcheggio: PARK LINE 2 - PA-300

DESCRIZIONE:

Pareti scorrevoli a parcheggio: PARK LINE 1 - PA-200

Struttura mista costituita:

- guida superiore in alluminio (fare riferimento alla relazione allegata per la verifica della resistenza al peso massimo dei vetri).
- carrelli di scorrimento in alluminio con ruote e perni in acciaio.
- Fascioni in alluminio per presa/sostegno vetri con relative velette e tappi (sempre in alluminio)
- Catinaccioli / serrature
- Sistemi per porte laterali fisse

PARK LINE 1 - PA-200

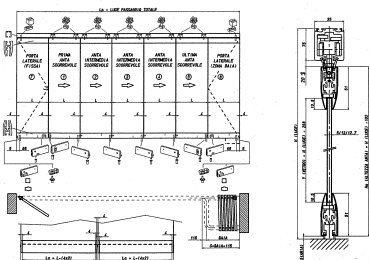

Pag.1

Pareti scorrevoli a parcheggio: PARK LINE 2 - PA-300

Struttura mista costituita:

Componenti analoghi a PA-200 descritto sopra con aggiunta di:

- Porte centrali scorrevoli con doppio fascione in alluminio per scorrimento/apertura porta

PARK LINE 2 - PA-300

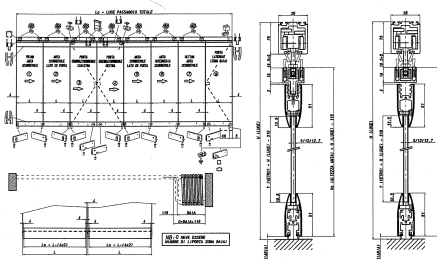

IPOTESI DI CARICO: pressione del vento sulle ante

Si considera come dato di ingresso una pressione sui serramenti in vetro/alluminio pari a

$$80 \text{ Kgfm}^2 = 800 \text{ Nm}^2$$

Questo dato è stato fornito come specifica e deriva dalla velocità del vento secondo le formule:

$$p = q_{ref} \times C_e \times C_p \times C_d \quad q_{ref} = v_{ref}^2 / 1.6$$

dove:

q_{ref} = pressione cinetica di riferimento (Nm²)

v_{ref} velocità del vento secondo le tabelle relative alla zona geografica e alla categoria dell'edificio)

C_e = coefficiente di esposizione

C_p = coefficiente di forma (o aerodinamico)

C_d = coefficiente dinamico

Pag.2



METALGLAS BONOMI SRL

Pareti scorrevoli a parcheggio: PARK LINE 1 - PA-200
 Pareti scorrevoli a parcheggio: PARK LINE 2 - PA-300
VERIFICA DI RESISTENZA DELLA GUIDA DI SCORRIMENTO

DATI DEL MATERIALE

Materiale : Alluminio Estruso EN 6060

TABELLA 13
 Lega di alluminio > Costanti

Strutturali	
Modulo di Young	71000 MPa
Coefficiente di Poisson	0,33
Densità	2,77e+006 kg/m ³
Elastico	
Espansione termica	2,3e-005 1/°C
Carico di snervamento a trazione	280, MPa
Carico di snervamento a compressione	280, MPa
Carico di rottura a trazione	310, MPa
Carico di rottura a compressione	0, MPa
Termico	
Calore specifico	875, J/kg °C
Elettromagnetico	
Permeabilità relativa	1
Resistività	5,7e-005 Ohm-m

FIGURA 8
 Lega di alluminio > Conduttività termica

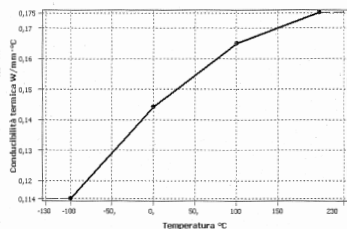

Pag.1

TABELLA 14
 Lega di alluminio > Conduttività termica > Conduttività termica in funzione di Temperatura

Temperatura °C	Conduttività termica W/m.m °C
-100	0,144
0	0,144
100	0,165
200	0,175

FIGURA 6
 Lega di alluminio > Sollecitazione alternata



TABELLA 15
 Lega di alluminio > Sollecitazione alternata > Attributi delle proprietà

Legenda:
 Interpolazione Semi-Log
 Tipo curve media Rapporto R1

TABELLA 16
 Lega di alluminio > Sollecitazione alternata > Sollecitazione alternata Dati curva

Cicli	Sollecitazione alternata MPa
1	270
10	240
100	200
1000	160
10000	120
100000	100
1000000	80
10000000	70
100000000	60
1000000000	50
10000000000	40
100000000000	30
1000000000000	20
10000000000000	15
100000000000000	10
1000000000000000	8
10000000000000000	6
100000000000000000	5
1000000000000000000	4
10000000000000000000	3
100000000000000000000	2
1000000000000000000000	1

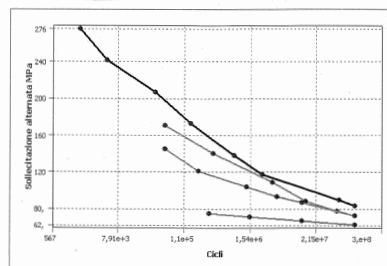
TABELLA 17
 Lega di alluminio > Sollecitazione alternata > Sollecitazione alternata in funzione di Cicli

Cicli	Sollecitazione alternata MPa
1700	275,8
5000	241,3
34000	206,8
1,4e+005	172,4
8,8e+005	137,9
2,4e+006	117,2
5,5e+007	89,63
1,1e+008	82,74

Pag.2

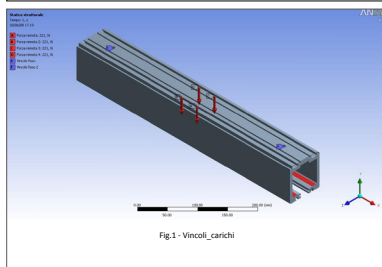

Fig.1 - Vincoli_carichi

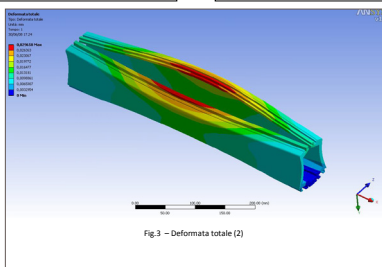

Fig.3 - Deformata totale (2)

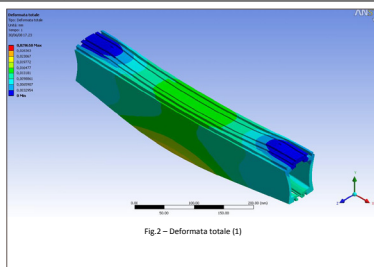

Fig.2 - Deformata totale (1)

PA-300 Park line 2

Sistema scorrevole a parcheggio con profili fermavetro a misure richieste dal cliente, senza fori nel vetro e con possibilità di porta centrale a battente e parcheggiabile.

Sliding stacking system with glass fixing profiles made to measure upon client's request, no need to make holes in the glass and with the possibility of hinged and parkable central panel.

Schiebesystem mit Parkraum, mit kundenspezifischen Glasleistenprofile mit zentraler Drehtür und Parkmöglichkeit.



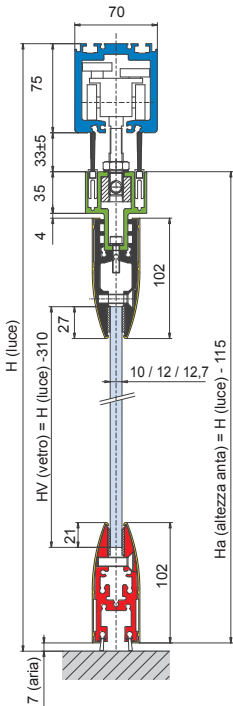

$HV = H - 310$

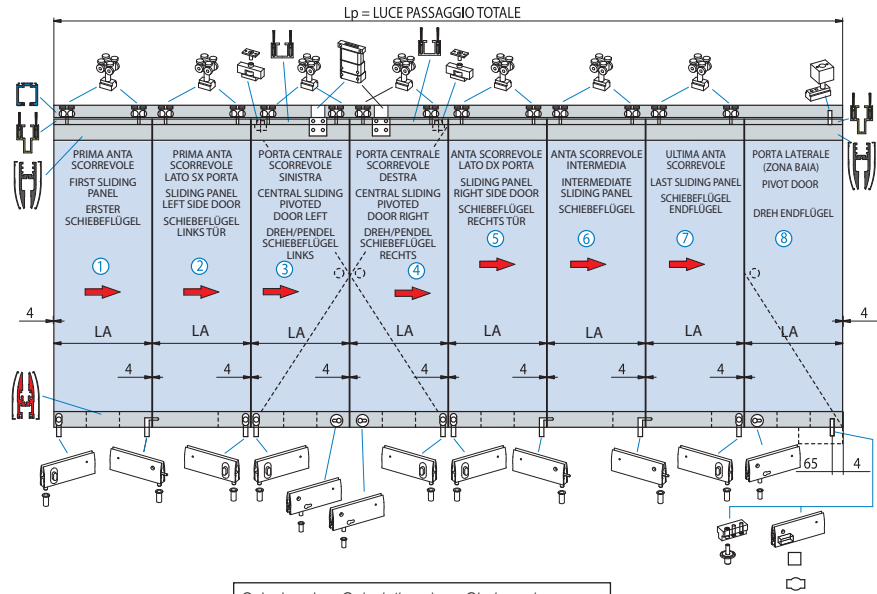

Calcolo vetro - Calculation glass - Glasberechnungen
 $At = 4 \times (N + 1)$
 $X = \text{[Luce larghezza totale (Lp) - Arie totali (At)]}$
 $X = N \times LA$
 $LA = LV = X / N$

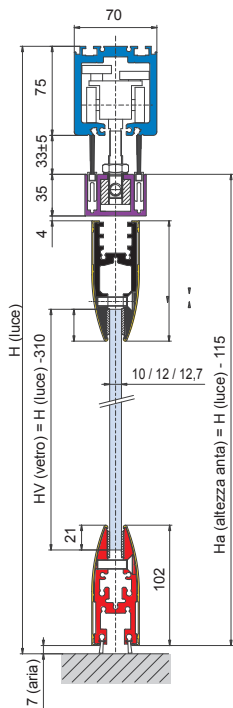

$HV = H - 310$

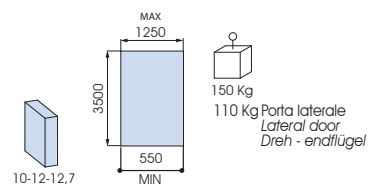
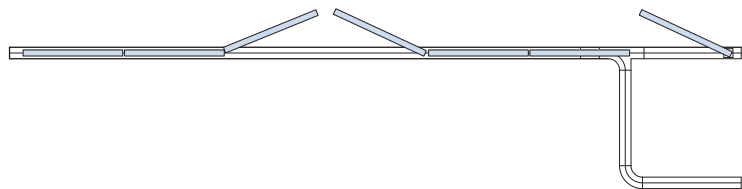
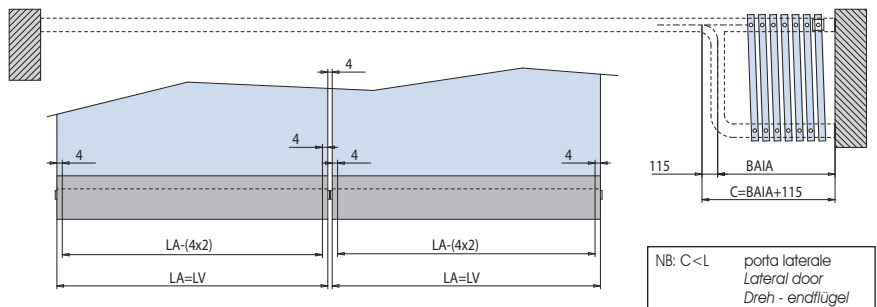

Componenti pag. 244
 Components from page 244
 Einzelteile Seite 244

sla 168

AN = Alluminio anodizzato
 Aluminium anodized
 Aluminium Silberfarbig

At = Arie totali
 Total clearances
 Summe alle Abstände Glas/Wand
 N = Numero ante
 Numbers panels
 Anzahl der Elemente

Lp = Luce larghezza passaggio totale
 Clear opening width
 Lichte Durchgangsbreite
 LA = LV Larghezza ante = Larghezza vetro
 Panel width = Glass width
 Flügelbreite = Glasbreite

H = Altezza passaggio luce
 Clear opening height
 Lichte Durchgangshöhe
 HV = Altezza vetro
 Glass height
 Glashöhe

PA-300 Park line 2

Componenti
Components
Einzelteile

PA-108

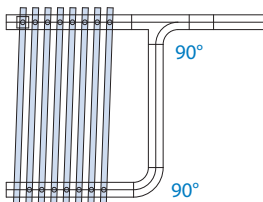

PA-109

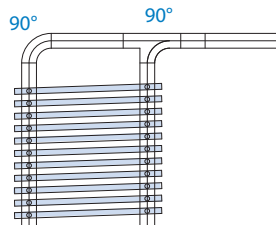

PA-100

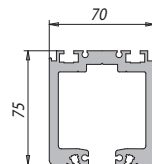

PA-113

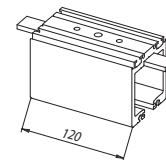

Da ordinare a parte oltre alle ante
To be ordered separately from the panels
Neben den Flügeln extra zu bestellen

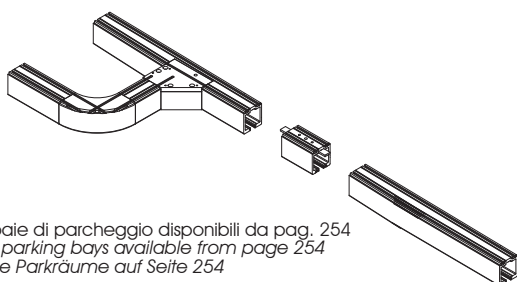

Altre baie di parcheggio disponibili da pag. 254
Other parking bays available from page 254
Andere Parkräume auf Seite 254

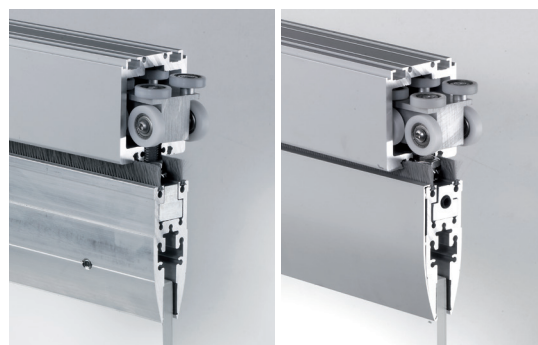

PA-201

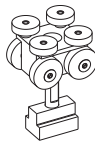

PA-205

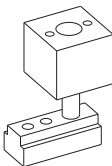

PA-206

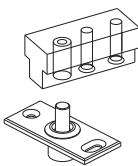

PA-312

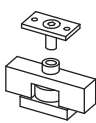

PA-215

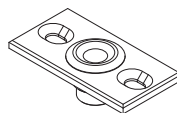

L-112-PA

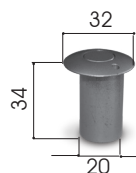

PA-211



PA-212



PA-202

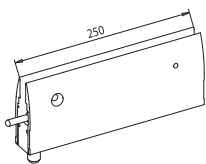

PA-203

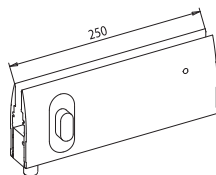

PA-204

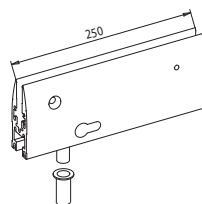

PA-207

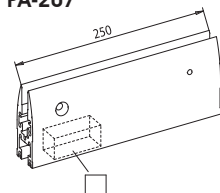

PA-208

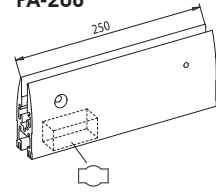

PA-209

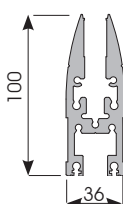

PA-210

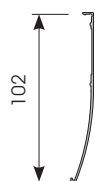

PA-307

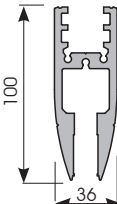

PA-313

Scambio per convertire l'anta porta battente del PA-300 in anta scorrevole parcheggiabile tramite l'apposita chiave snodata.
 Mechanism to convert the central pivoted door of PA-300 in sliding door parkable through the appropriate tool.
 System um die zentrale Dreh-Tür des PA-300 in Schiebetür durch das entsprechende Werkzeug umzuwandeln.

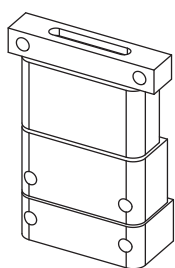

PA-308

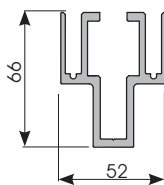

PA-309

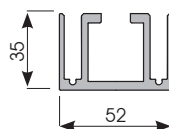

PA-310

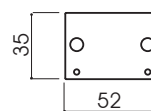

PA-311

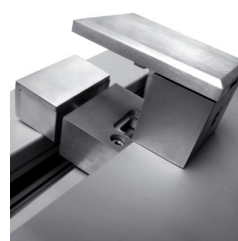
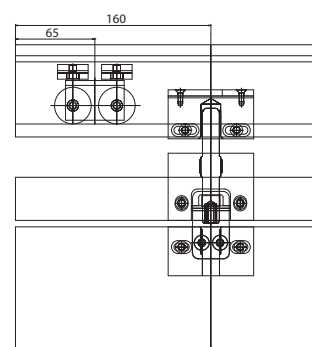
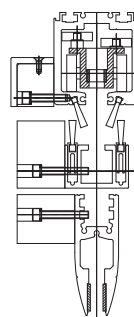
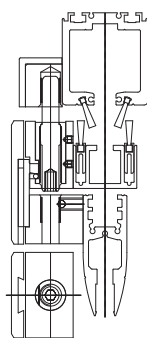

PA-400 Park do-it-yourself *new 2014*

Sistema scorrevole modulare a parcheggio con morsetti fermavetro (mm 250) e veletta continua (mm 1200) da tagliare secondo necessità a cura del cliente. Vantaggi di una consegna più veloce e di un unico prodotto a magazzino per tutte le misure fino a 1200 mm.

Modular sliding stacking system with glass fixing clamps (mm 250) and continuous covers (mm 1200) to be cut on the basis of client's requirements. The advantage of this product is quick delivery and a unique product available in the warehouse for all sizes up to 1200 mm.

Modulares Schiebeyesystem mit Parkraum, Glashalteklammern (250 mm) mit kontinuierlicher Verkleidung (mm 1200) kundenspezifisch abläßbar. Vorteile einer raschen Lieferung und eines einzigen lagermäßigen Produktes mit Abmessungen bis 1200 mm.



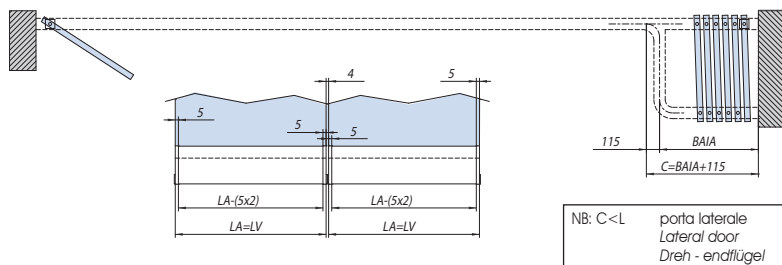
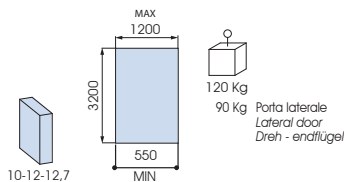
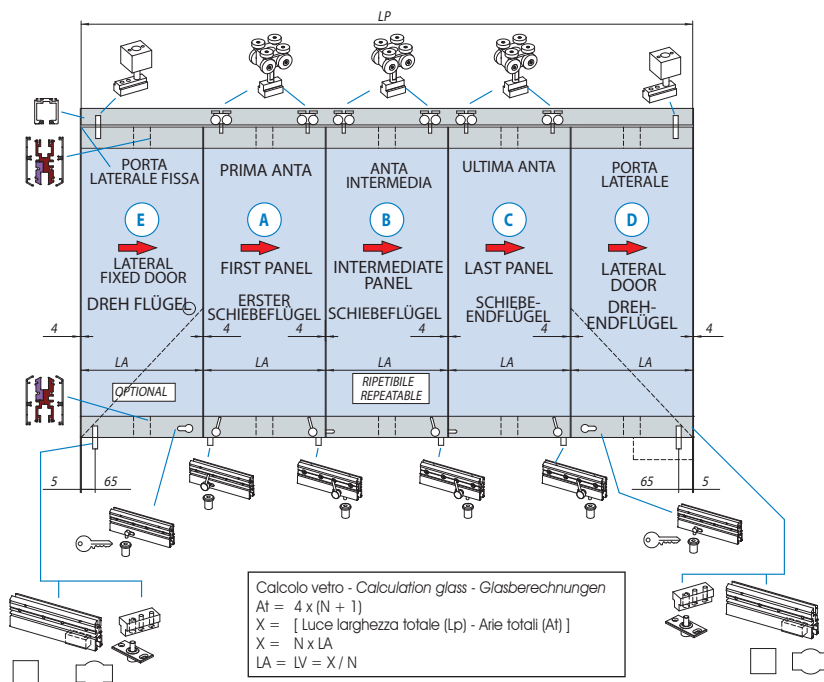
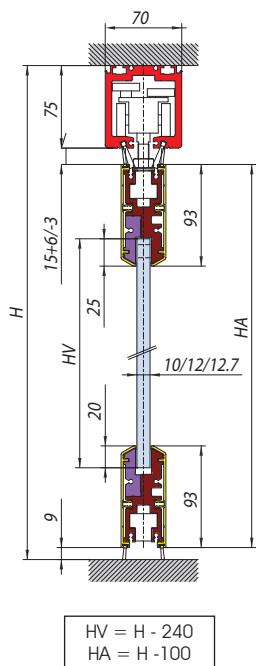
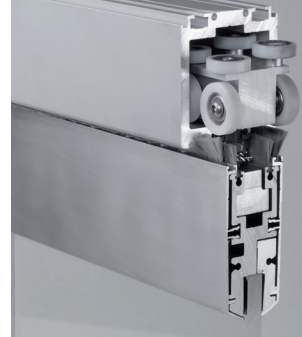

Componenti pag. 248
Components from page 248
Einzelteile Seite 248

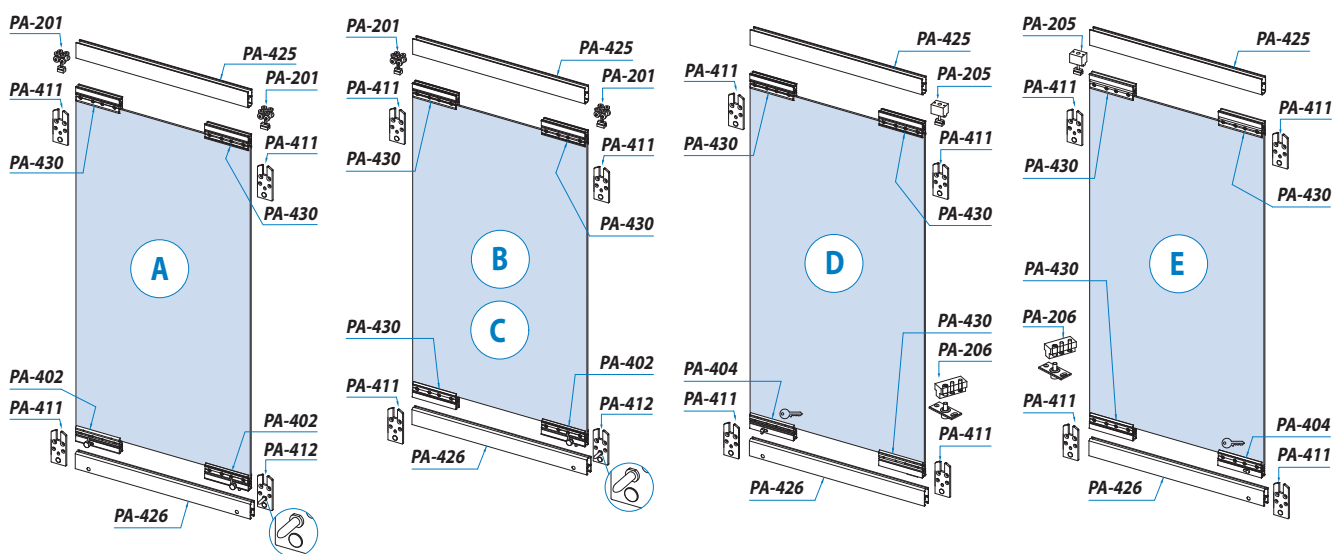

sla 333d

AN = Alluminio anodizzato
Aluminium anodized
Alluminium Silberfarbig

At = Arie totali
Total clearances
Summe alle Abstände Glas/Wand
N = Numero ante
Numbers panels
Anzahl der Elemente

Lp = Luca larghezza passaggio totale
Clear opening width
Lichte Durchgangsbreite
LA = LV Larghezza ante = Larghezza vetro
Panel width = Glass width
Flügelbreite = Glasbreite

H = Altezza passaggio luce
Clear opening height
Lichte Durchgangshöhe
HV = Altezza vetro
Glass height
Glashöhe

PA-400 Park do-it-yourself *new 2014*

Componenti
Components
Einzelteile

SCORREVOLI A PARCHEGGIO
SLIDING STACKING SYSTEMS



PA-108

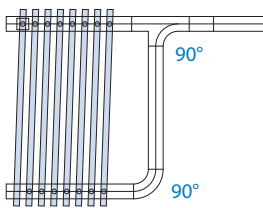

PA-109

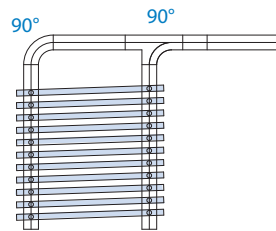

PA-100

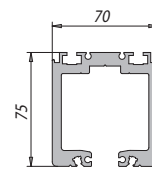

PA-113

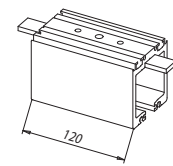

Da ordinare a parte oltre alle ante / To be ordered separately from the panels / Neben den Flügeln extra zu bestellen

Altre baie di parcheggio disponibili da pag. 254
Other parking bays available from page 254
Andere Parkräume auf Seite 254

PA-201

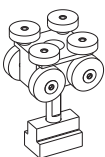

PA-205

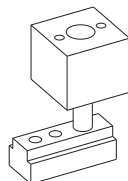

PA-206

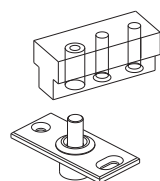

L-112-PA

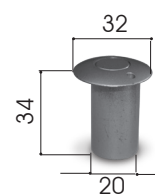

PA-411

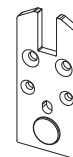

PA-412

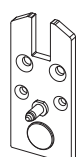



PA-402

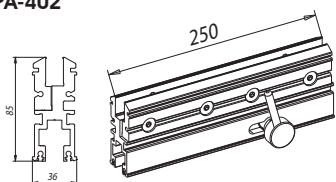

PA-430

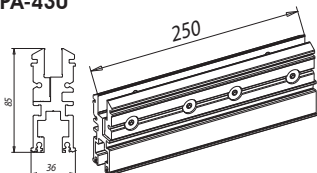

PA-404

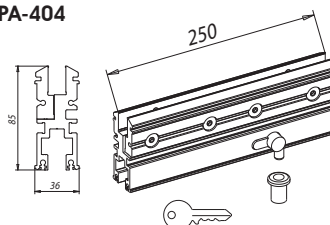

PA-408

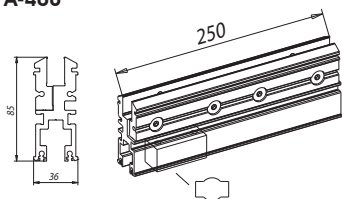

PA-407

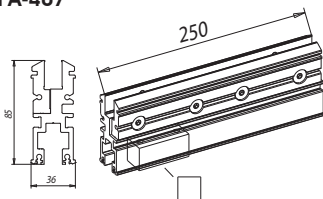

Da tagliare cliente
Adjust the length
Beliebig Kürzbar

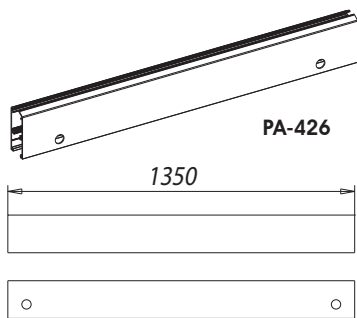
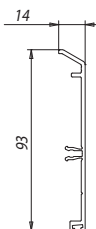

Da tagliare cliente
Adjust the length
Beliebig Kürzbar

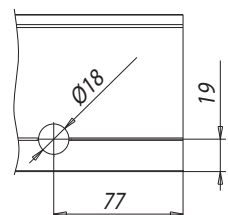
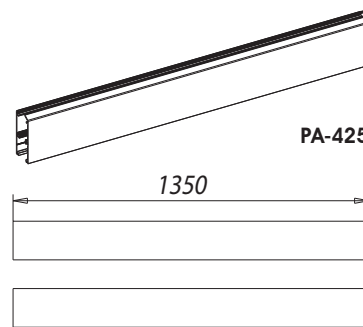
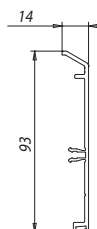

Solo per le velette dell'anta "a" che hanno 2 fori è necessario tagliarle e rifare il secondo foro seguendo la linea di guida interna a mm. 77
Only for the covers in door "A" with 2 holes: it is necessary to cut them to size and make the second hole again following the internal guide line 77 mm from the border.

Nur die Verkleidungen des Flügels "A", die zwei Bohrungen haben, müssen zugeschnitten werden und die zweite Bohrung muss entlang der inneren Führung 77 mm vom Rand neu gemacht werden.

xla 333

PA-500 Park do-it-yourself *new 2014*

Sistema scorrevole a parcheggio con profili fermavetro continui a misura standard (mm 1200) da tagliare secondo necessità a cura del cliente, completi di catenaccioli fermaanta a posizionamento esterno regolabile. Vantaggi di una consegna più veloce e di un unico prodotto a magazzino per tutte le misure fino a 1200 mm.

Modular sliding stacking system with continuous glass fixing profiles of a standard size (mm 1200) to be cut on the basis of client's requirements comes equipped with an adjustable door holding latch positioned externally. The advantage of this product is quick delivery and a unique product available in the warehouse for all sizes up to 1200 mm.

Schiebesystem mit Parkraum, durchgehenden Laufschiene-Profilen in Standardgröße (1200 mm), ablängbar, komplett mit äußeren einstellbaren Riegeln zur Flügelbefestigung. Vorteile einer raschen Lieferung und eines einzigen lagermäßigen Produktes mit Abmessungen bis 1200 mm.

SCORREVOLI A PARCHEGGIO
SLIDING STACKING SYSTEMS



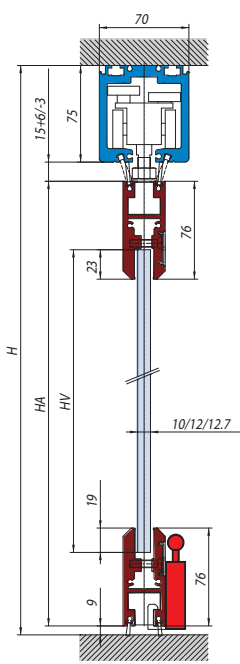

HV = H - 210
HA = H - 100

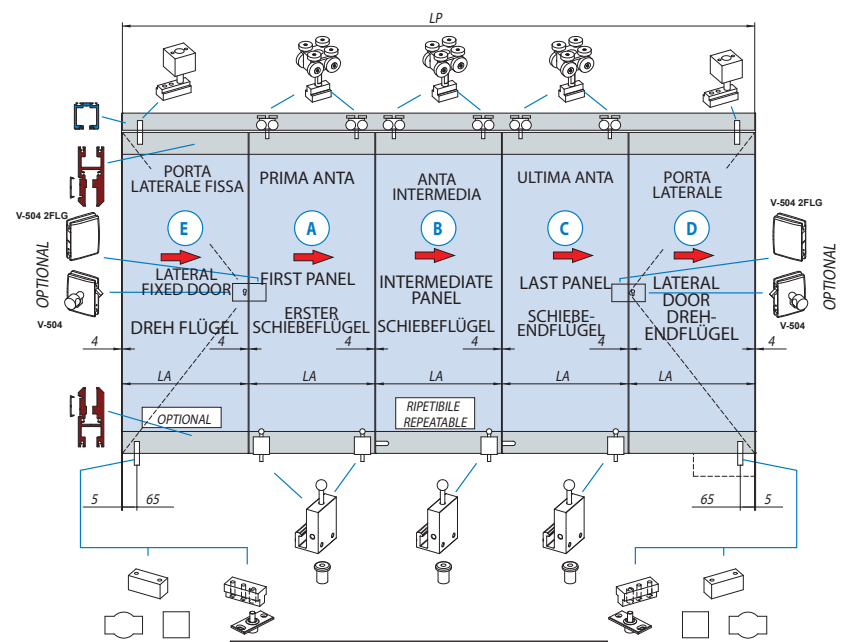

Calcolo vetro - Calculation glass - Glasberechnungen
 $A_t = 4 \times (N + 1)$
 $X = [\text{Luca larghezza totale (Lp)} - \text{Arie totali (A_t)}]$
 $X = N \times LA$
 $LA = LV \times N$

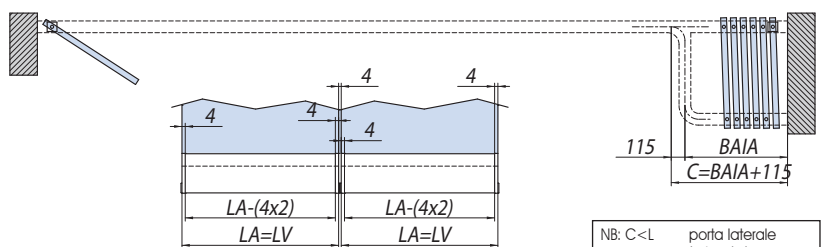
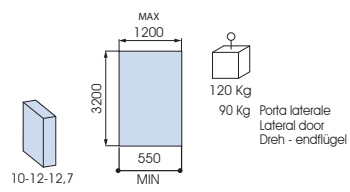

NB: C < L porta laterale
Lateral door
Dreh - endflügel

Componenti pag. 252
Components from page 252
Einzelteile Seite 252

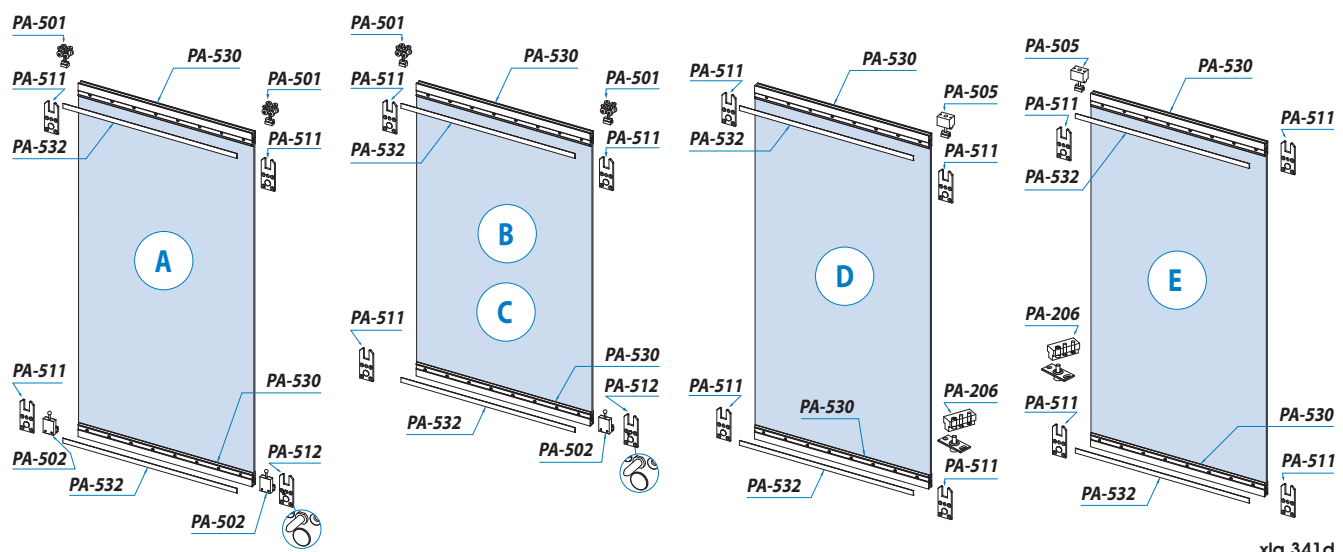

xla 341d

- | | | | |
|---|--|--|---|
| AN = Alluminio anodizzato
Aluminium anodized
Aluminium Silberfarbig | At = Arie totali
Total clearances
Summe alle Abstände Glas/Wand | Lp = Luca larghezza passaggio totale
Clear opening width
Lichte Durchgangsbreite | H = Altezza passaggio luce
Clear opening height
Lichte Durchgangshöhe |
| N = Numero ante
Numbers panels
Anzahl der Elemente | LA = LV Larghezza ante = Larghezza vetro
Panel width = Glass width
Flügelbreite = Glasbreite | | HV = Altezza vetro
Glass height
Glashöhe |

PA-500 Park do-it-yourself *new 2014*

Componenti
Components
Einzelteile

SCORREVOLI A PARCHEGGIO
SLIDING STACKING SYSTEMS



PA-108

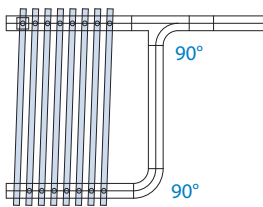

PA-109

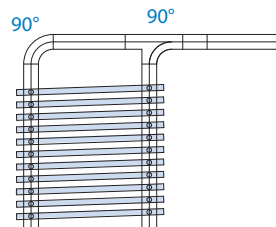

PA-100

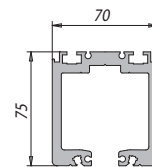

PA-113

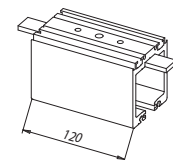

Da ordinare a parte oltre alle ante / To be ordered separately from the panels / Neben den Flügeln extra zu bestellen
Altre baie di parcheggio disponibili da pag. 254 / Other parking bays available from page 254 / Andere Parkräume auf Seite 254

PA-201

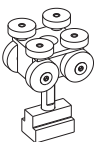

PA-205

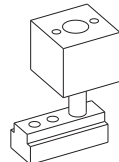

PA-206

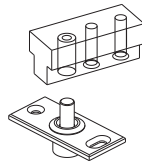

L-512-PA

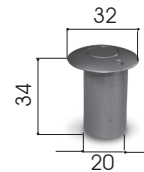

PA-511

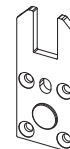

PA-512

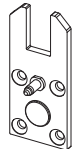

PA-509

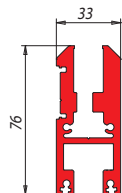

PA-510

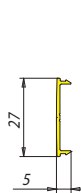

PA-502
standard

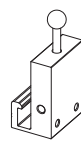

PA-504

a scatto optional 2014
optional clicking latch 2014
optional Riegel mit Feder 2014

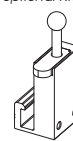

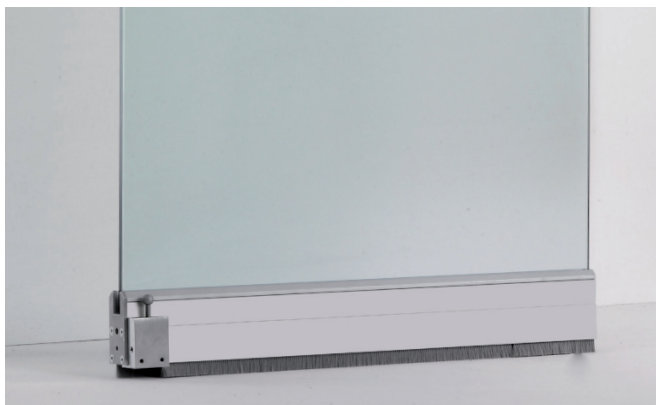

Da tagliare cliente
Adjust the length
Beliebig Kürzbar

PA-530

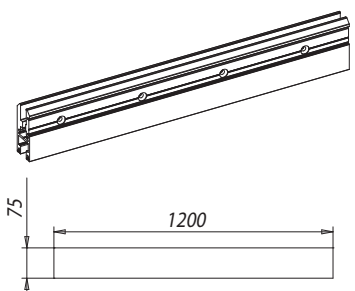
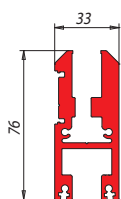

Da tagliare cliente
Adjust the length
Beliebig Kürzbar

PA-507

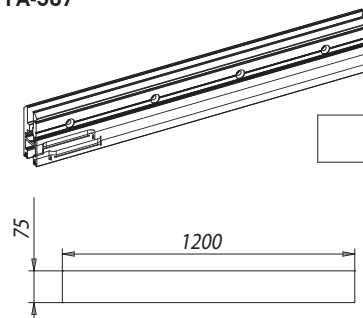
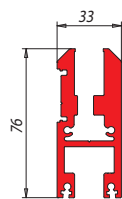

Da tagliare cliente
Adjust the length
Beliebig Kürzbar

PA-508

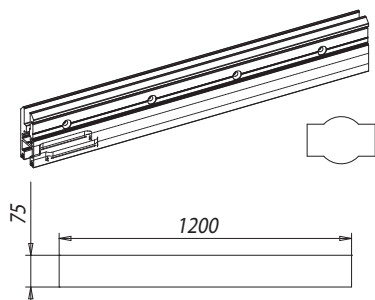
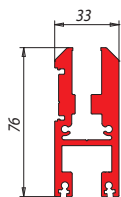

Da tagliare cliente
Adjust the length
Beliebig Kürzbar

PA-532

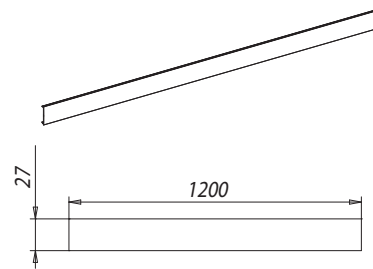
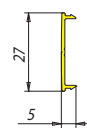

xla 341

Esempi baia parcheggio

Examples parking areas
Beispiele Parksituationen

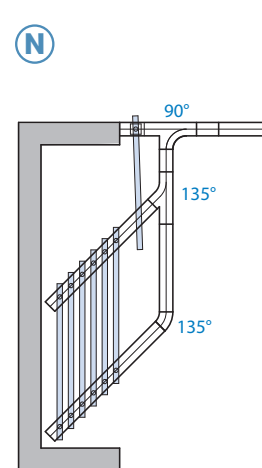
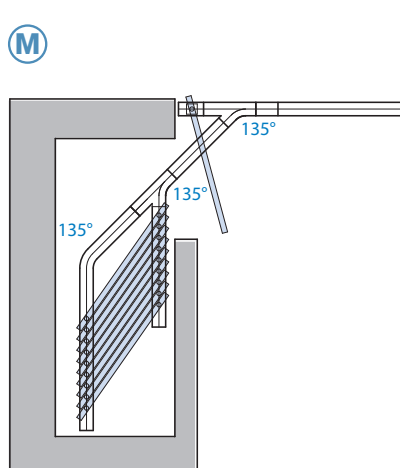
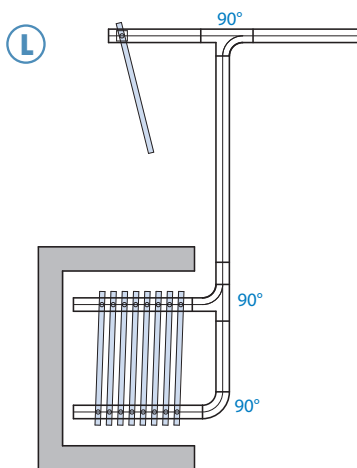
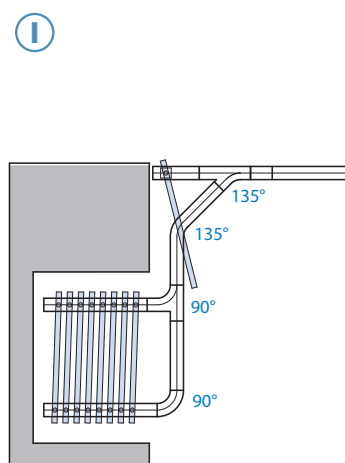
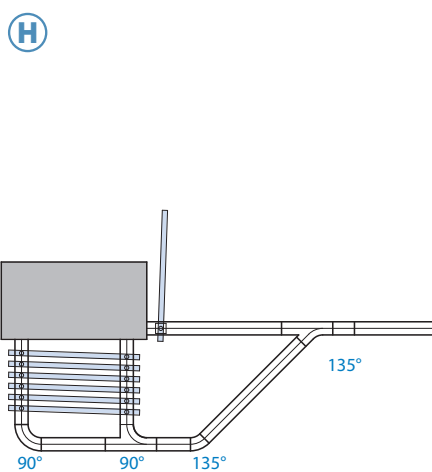
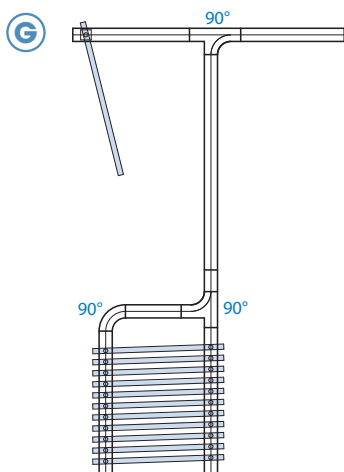
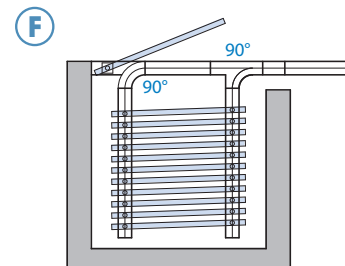
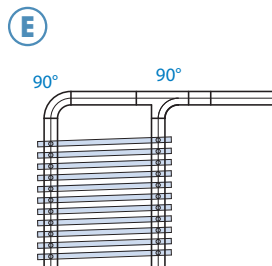
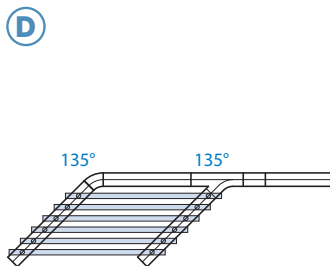
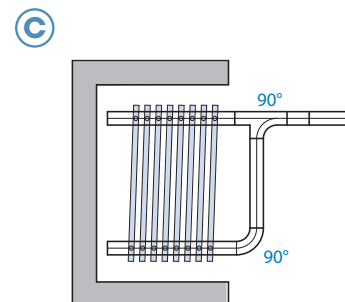
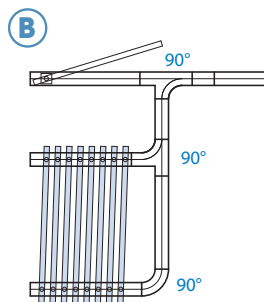
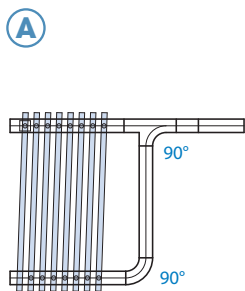

PA-108

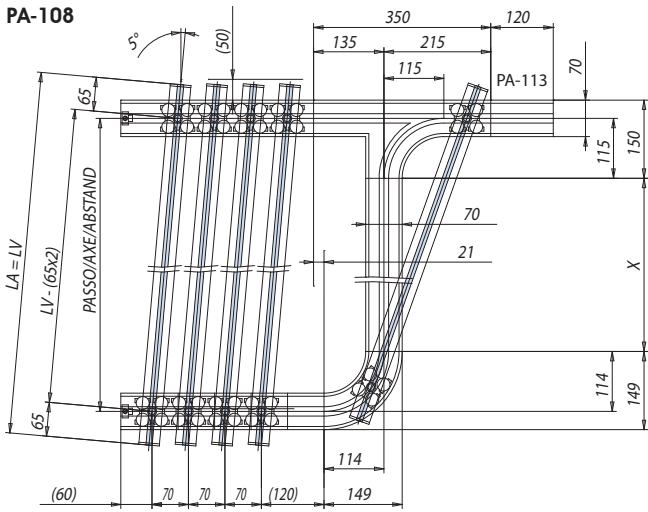

$$\text{Passo} = [LV - (65 \times 2)] \times 0.996$$

$$X = \text{Passo} - 135 - 114$$

NB: C<LA Porta laterale
Lateral door
Dreh - endflügel

Vista dall'alto (da sopra il profilo guida)
View from above the rail
Sicht von oben über der Laufschiene

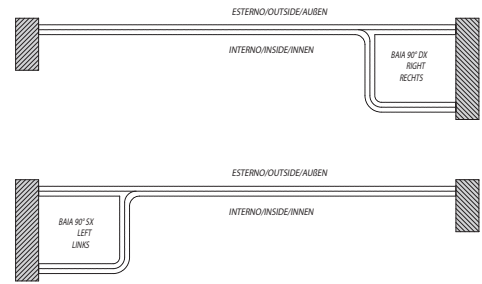

PA-109

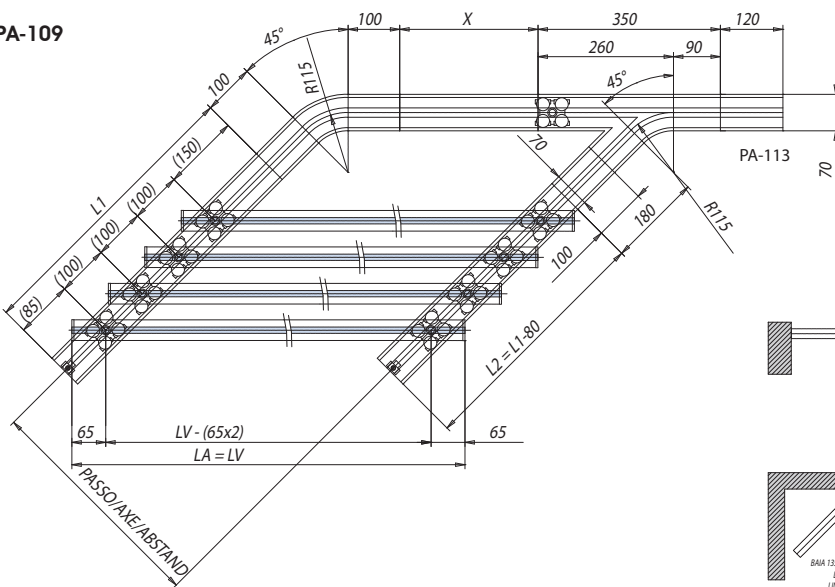

$$\text{Passo} = [LV - (65 \times 2)] \times 0.996$$

$$X = \text{Passo} - 135 - 114$$

NB: C<LA Porta laterale
Lateral door
Dreh - endflügel

Vista dall'alto (da sopra il profilo guida)
View from above the rail
Sicht von oben über der Laufschiene

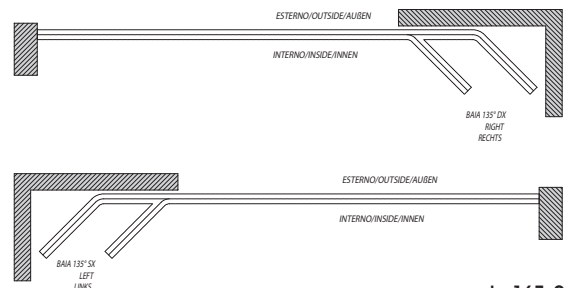

xla 167_0



Passo = Interasse carrelli
Axe
Abstand

LA = LV Larghezza ante = Larghezza vetro
Panel width = Glass width
Flügelbreite = Glasbreite

Baia parcheggio

Parking area
Parksituation

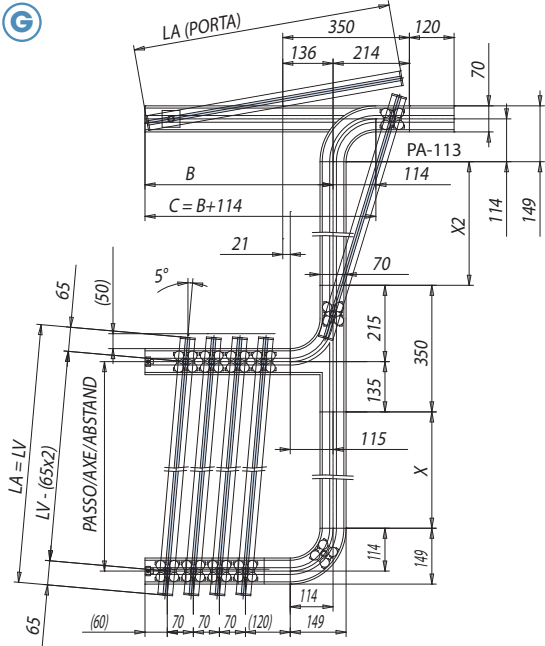

$$\text{Passo} = [LV - (65 \times 2)] \times 0.996$$

$$X = \text{Passo} - 135 - 114$$

NB: $C < LA$ Porta laterale
Lateral door
Dreh - endflügel

Vista dall'alto (da sopra il profilo guida)
View from above the rail
Sicht von oben über der Laufschiene

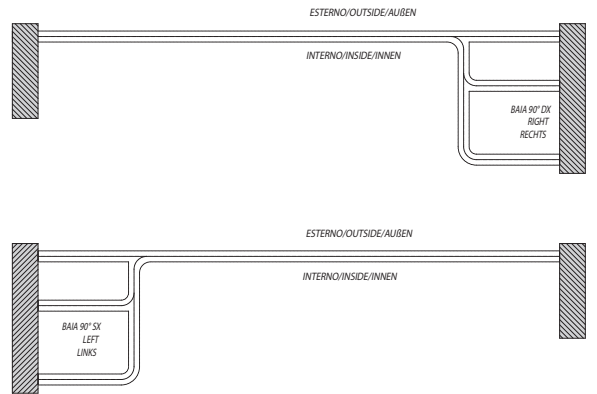

xla167_0

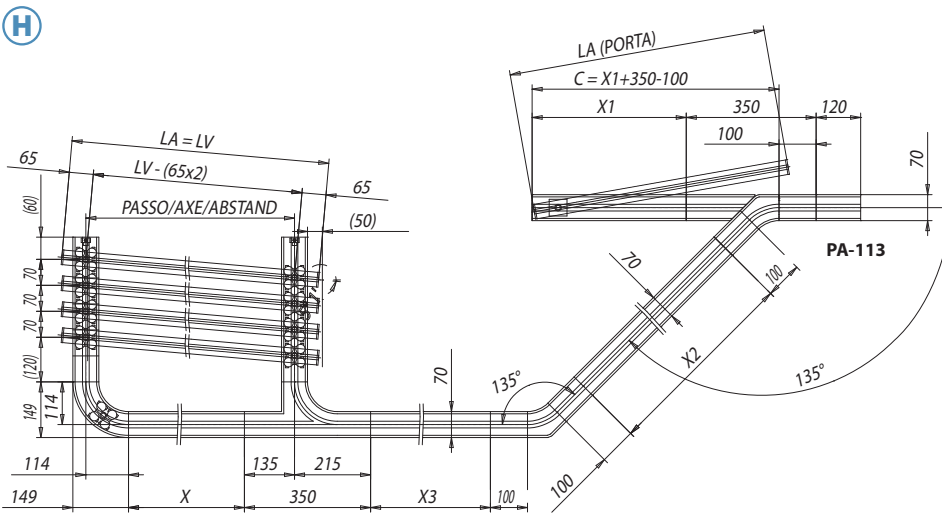

$$\text{Passo} = [LV - (65 \times 2)] \times 0.996$$

$$X = \text{Passo} - 135 - 114$$

NB: $C < LA$ Porta laterale
Lateral door
Dreh - endflügel

Vista dall'alto (da sopra il profilo guida)

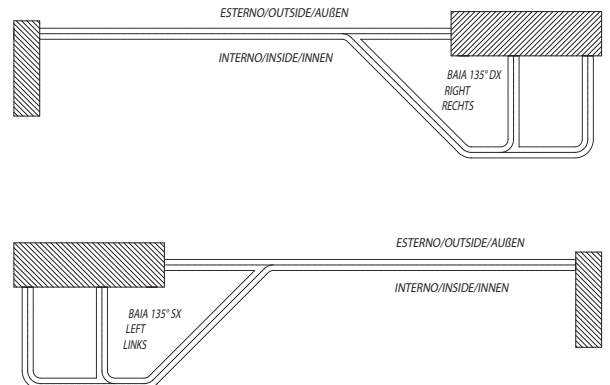

xla167_1

Passo = Interasse carrelli
Axe
Abstand

LA = LV Larghezza ante = Larghezza vetro
Panel width = Glass width
Flügelbreite = Glasbreite

Baia parcheggio

Parking area
Parksituation



Scorrevoli a libro

Con guida a terra
Sliding folding systems with bottom guide channel
Falt-Schiebewandssysteme mit Bodenführung

D

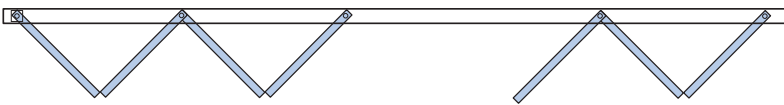

PA-250 Libro folding

(pag. 260)

Sistema scorrevole a parcheggio fornito con profili fermavetro a misure richiesta dal cliente, senza necessità di fori nel vetro.
Sliding folding door system with glass fixing profiles made to measure upon client's request, no need to make holes in the glass.
Falt-Schiebewandssystem, mit kundenspezifischen Glasleistenprofilen, ohne Glasbohrungen

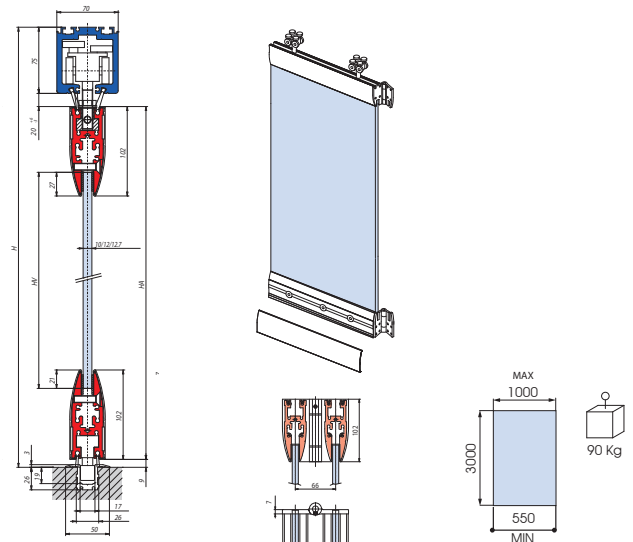

PA-450 Libro folding do-it-yourself

(pag. 264)

Sistema scorrevole modulare a libro con morsetti fermavetro (mm 250) e veletta continua (mm 1200) da tagliare secondo necessità a cura del cliente. Vantaggi di una consegna più veloce e di un unico prodotto a magazzino per tutte le misure fino a 1200 mm.
Sliding folding door system with glass fixing clamps (mm 250) and continuous covers (mm 1200) to be cut on the basis of client's requirements. The advantage of this product is quick delivery and a unique product available in the warehouse for all sizes up to 1200 mm.
Modulares Schiebeyesystem mit Glashalteklammern (250 mm) und kontinuierlicher Verkleidung (1200 mm), kundenspezifisch ablängbar. Vorteile einer raschen Lieferung und eines einzigen lagermäßigen Produktes mit Abmessungen bis 1200 mm.

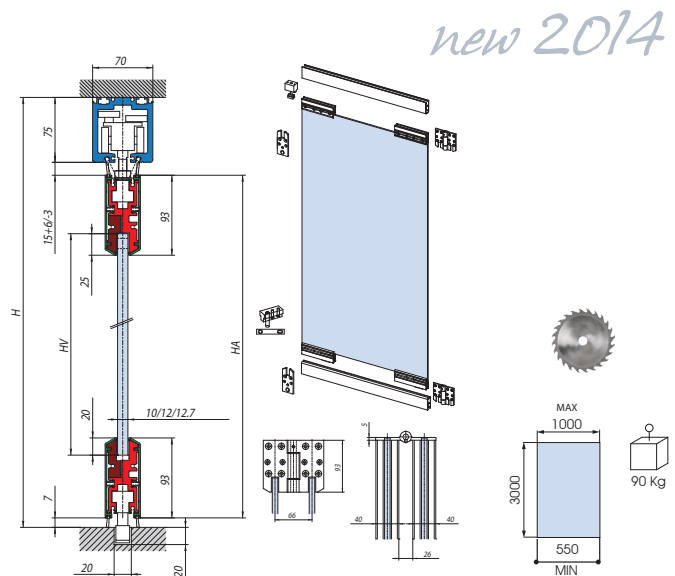

PA-550 Libro folding do-it-yourself

(pag. 268)

Sistema scorrevole a libro con profili fermavetro continui a misura standard (mm 1200) da tagliare secondo necessità a cura del cliente, completi di catenaccioli fermaanta a posizionamento esterno regolabile. Vantaggi di una consegna più veloce e di un unico prodotto a magazzino per tutte le misure fino a 1200 mm.

Sliding folding door system with continuous glass fixing profiles of a standard size (mm 1200) to be cut on the basis of client's requirements comes equipped with an adjustable door holding latch positioned externally. The advantage of this product is quick delivery and a unique product available in the warehouse for all sizes up to 1200 mm.

Schiebesystem mit durchgehenden Glasleistenprofilen in Standardgröße (1200 mm), abhänger, komplett mit äußeren einstellbaren Riegeln zur Flügelfeststellung. Vorteile einer raschen Lieferung und eines einzigen lagermäßigen Produktes mit Abmessungen bis 1200 mm.

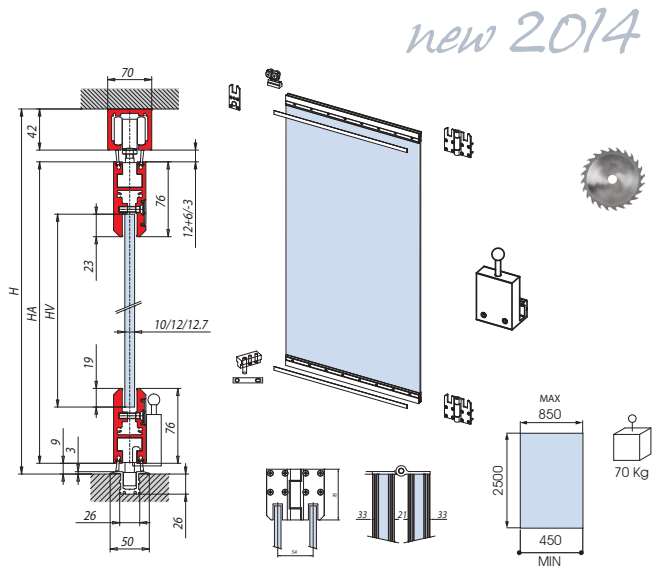

L-1000 Libro folding

(pag. 272)

Sistema scorrevole a libro con cerniere a vista e fori nel vetro, completo di binario standard h=75 mm x L=70 mm e carrello con 8 ruote.

Sliding folding door system with visible hinges and holes in glass, including standard rail h=75 mm x L=70 mm and carriage with 8 wheels

Faltschiebewandssystem mit sichtbaren Bändern und Glasbohrungen, komplett mit Standard-Laufschiene h=75 mm x L=70 mm und Laufwagen mit 8 Rädern

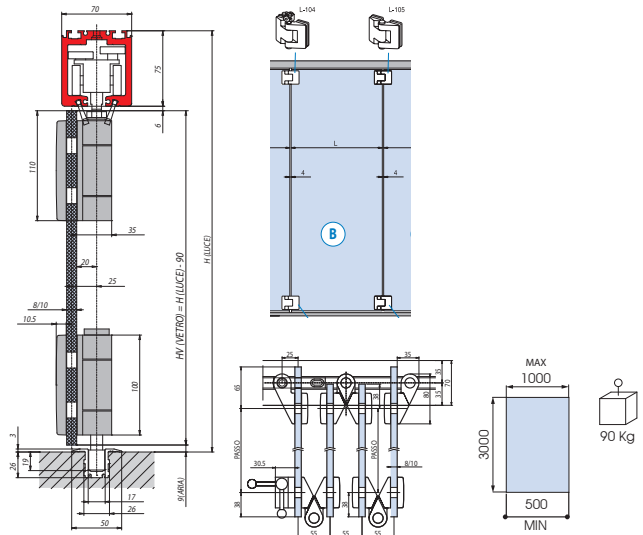

L-1500 Libro folding

(pag. 274)

Sistema scorrevole a libro con cerniere a vista e fori nel vetro, completo di binario standard h=42 mm x L=45 mm e carrello con 4 ruote.

Sliding folding door system with visible hinges and holes in glass, including standard rail h=42 mm x L=45 mm and carriage with 4 wheels

Faltschiebewandssystem mit sichtbaren Bändern und Glasbohrungen, komplett mit Standard-Laufschiene h=42 mm x L=45 mm und Laufwagen mit 4 Rädern

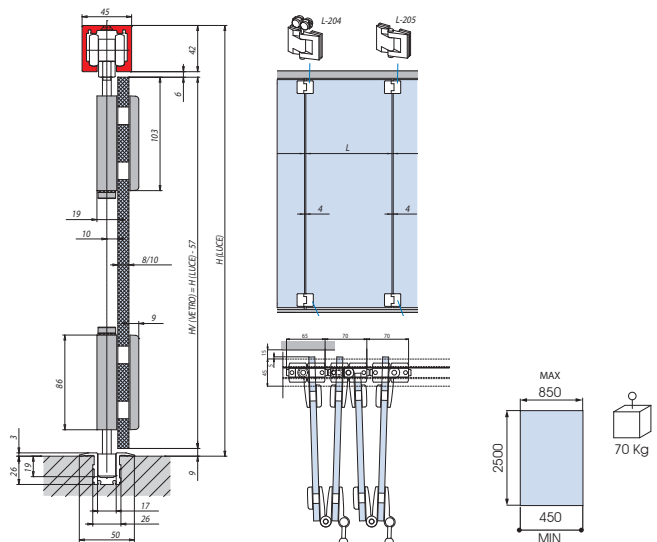

PA-250 Libro Folding

Sistema scorrevole a libro fornito con profili fermavetro a misura richiesta dal cliente, senza necessità di fori nel vetro.

Sliding folding door system with glass fixing profiles made to measure upon client's request, no need to make holes in the glass.

Falt-Schiebewandssystem, mit kundenspezifischen Glasleistenprofilen, ohne Glasbohrungen



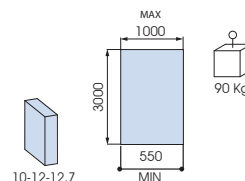
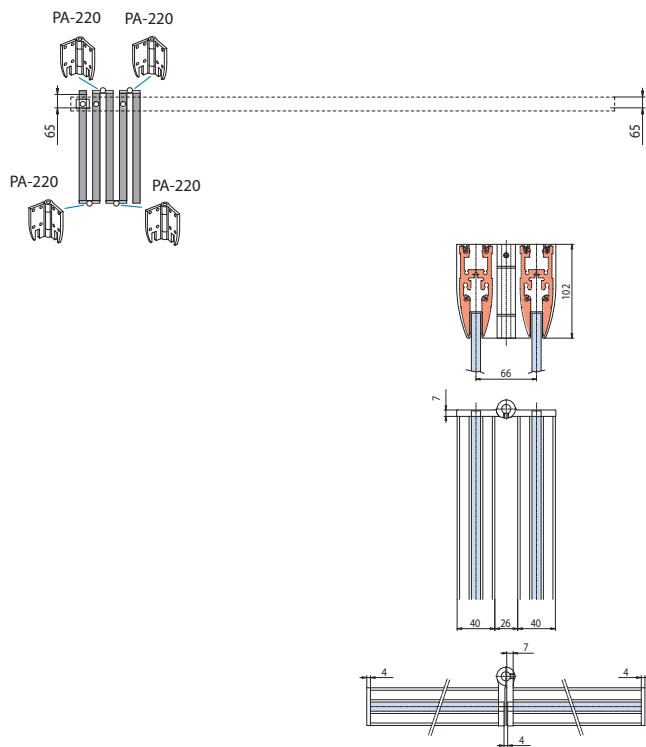
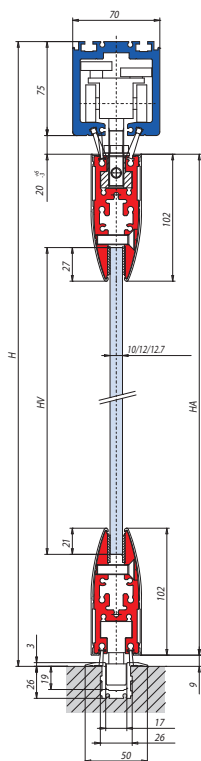

HV = H - 258
HA = H - 102

	PA-250 SET 2
	PA-250 SET 3
	PA-250 SET 4
	PA-250 SET 5
	PA-250 SET 6
	PA-250 SET 7

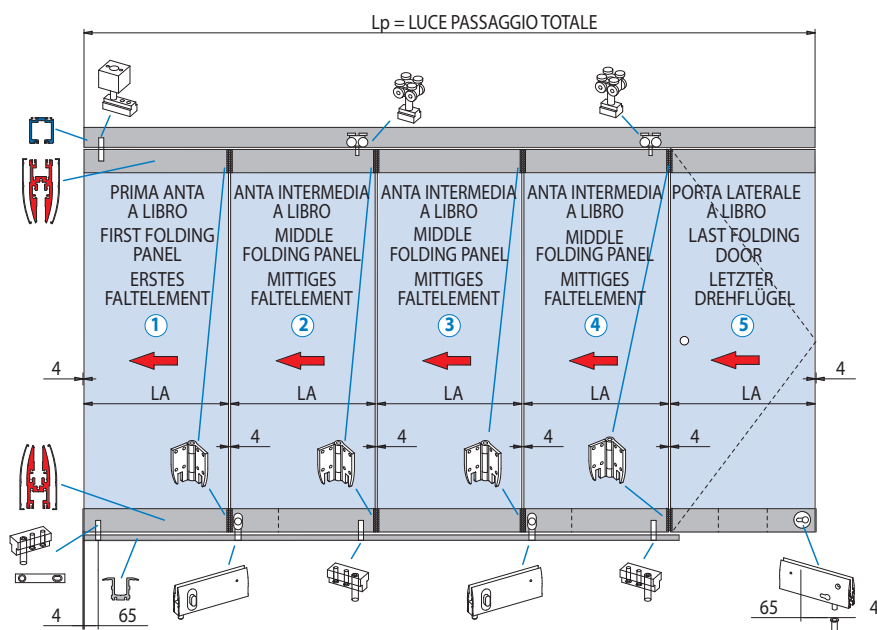

Componenti pag. 262
Components from page 262
Einzelteile Seite 262

Calcolo vetro - Calculation glass - Glasberechnungen
At = 4 x (N + 1)
X = [Luce larghezza totale (Lp) - Arie totali (At)]
X = N x LA
LA = LV x N

sla 170

AN = Alluminio anodizzato
Aluminium anodized
Aluminium Silberfarbig

At = Arie totali
Total clearances
Summe alle Abstände Glas/Wand
N = Numero ante
Numbers panels
Anzahl der Elemente

Lp = Luce larghezza passaggio totale
Clear opening width
Lichte Durchgangsbreite
LA = LV Larghezza ante = Larghezza vetro
Panel width = Glass width
Flügelbreite = Glasbreite

H = Altezza passaggio luce
Clear opening height
Lichte Durchgangshöhe
HV = Altezza vetro
Glass height
Glashöhe

PA-250 Libro Folding

Componenti
Components
Einzelteile

SCORREVOLI A LIBRO
SLIDING FOLDING SYSTEMS



PA-100

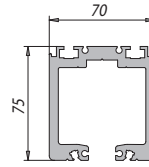

PA-113

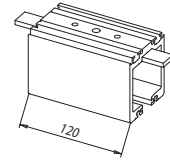

L-113 standard

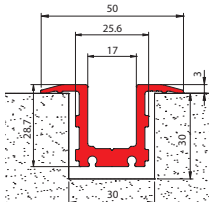

L-110 optional

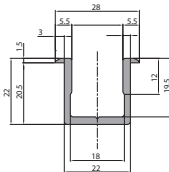

PA-201

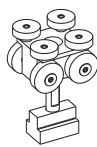

PA-205

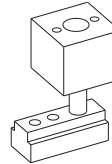

PA-206

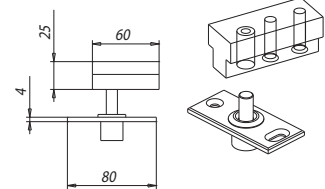

PA-221

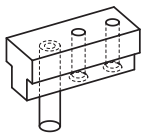

PA-222

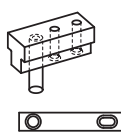

PA-220

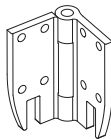

PA-215

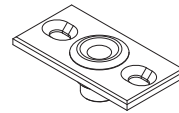

PA-211



PA-212



PA-202

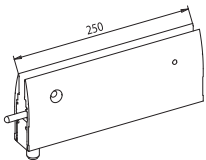

PA-203

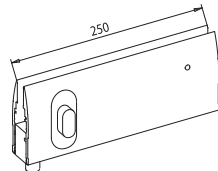

PA-204

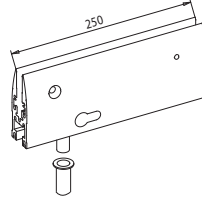

PA-207

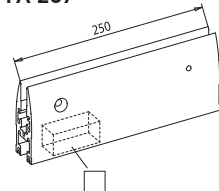

PA-208

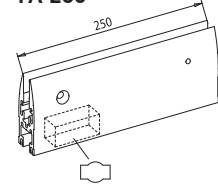

PA-209

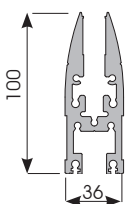

PA-210

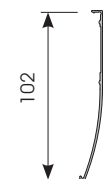



PA-450 Libro Folding do-it-yourself *new 2014*

Sistema scorrevole modulare a libro con morsetti fermavetro (mm 250) e veletta continua (mm 1200) da tagliare secondo necessità a cura del cliente. Vantaggi di una consegna più veloce e di un unico prodotto a magazzino per tutte le misure fino a 1200 mm.

Sliding folding door system with glass fixing clamps (mm 250) and continuous covers (mm 1200) to be cut on the basis of client's requirements. The advantage of this product is quick delivery and a unique product available in the warehouse for all sizes up to 1200 mm.

Modulares Schiebesystem mit Glashalteklammern (250 mm) und kontinuierlicher Verkleidung (1200 mm), kundenspezifisch abklängbar. Vorteile einer raschen Lieferung und eines einzigen lagermäßigen Produktes mit Abmessungen bis 1200 mm.



	PA-450 SET 2 (A E)
	PA-450 SET 3 (A B D)
	PA-450 SET 4 (A B C E)
	PA-450 SET 5 (A B C B D)

	PA-450 SET 6 (A B C B C E)
	PA-450 SET 7 (A B C B C B D)

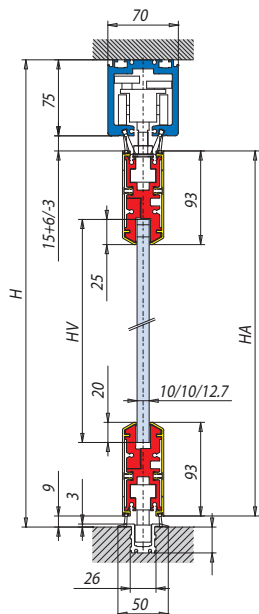

HV = H - 240
HA = H - 100

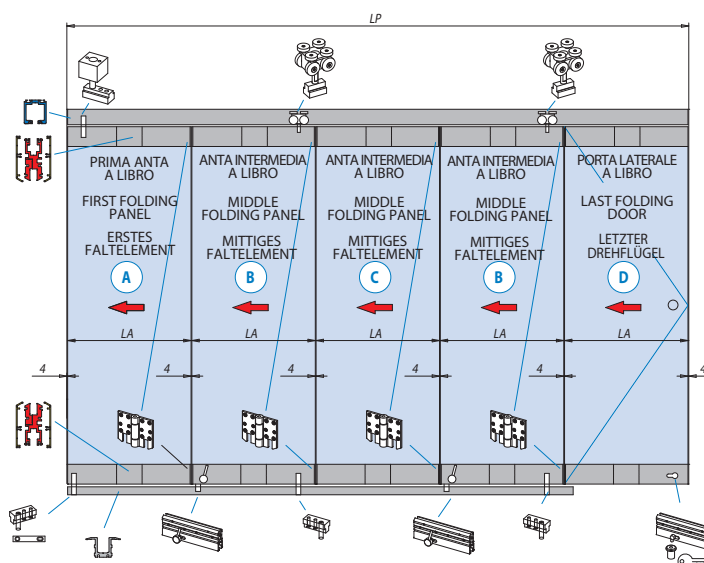
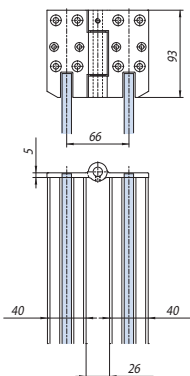

Calcolo vetro - Calculation glass - Glasberechnungen
 $A_t = 4 \times (N + 1)$
 $X = [\text{Luce larghezza totale (Lp) - Arie totali (A_t)}]$
 $X = N \times LA$
 $LA = LV \times X / N$

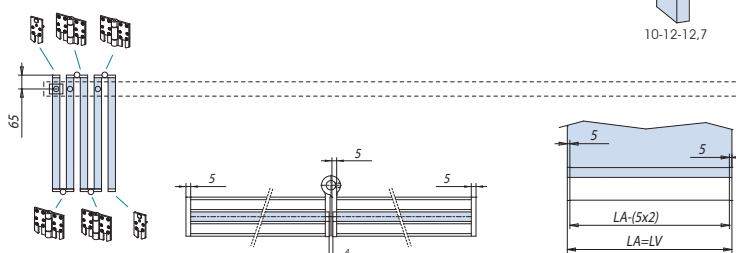
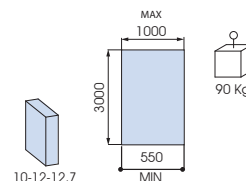

Componenti pag. 266
Components from page 266
Einzelteile Seite 266

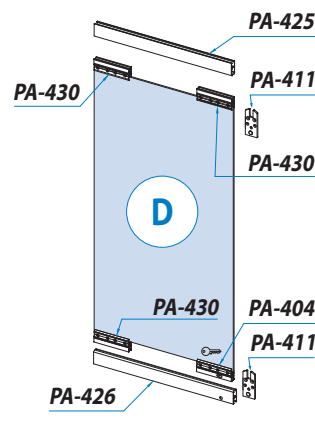
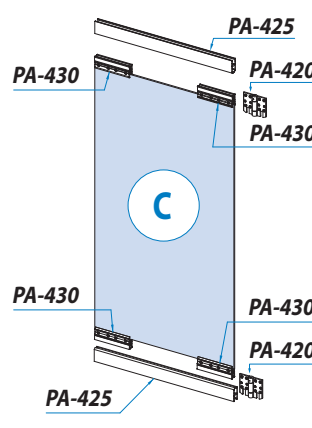
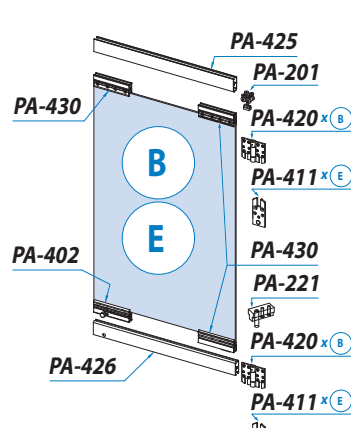
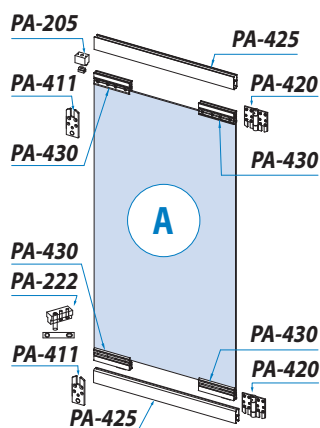

(B) Anta intermedia con catenacciolo
Middle panel with latch
Zwischenflügel mit Riegel

(E) Ultima anta con N° ante pari
Last panel with even no. panels
Letzter Flügel bei gerader Flügelanzahl

(D) Ultima anta a porta battente con n° ante dispari
Last hinged door with odd no. panels
Letzter Drehflügel bei ungerader Flügelanzahl

xla 334c

AN = Alluminio anodizzato
Aluminium anodized
Aluminium Silberfarbig

At = Arie totali
Total clearances
Summe alle Abstände Glas/Wand

N = Numero ante
Numbers panels
Anzahl der Elemente

Lp = Luce larghezza passaggio totale
Clear opening width
Lichte Durchgangsbreite

LA = LV Larghezza ante = Larghezza vetro
Panel width = Glass width
Flügelbreite = Glasbreite

H = Altezza passaggio luce
Clear opening height
Lichte Durchgangshöhe

HV = Altezza vetro
Glass height
Glashöhe

PA-450 Libro Folding do-it-yourself *new 2014*

Componenti
Components
Einzelteile

SCORREVOLI A LIBRO
SLIDING FOLDING SYSTEMS

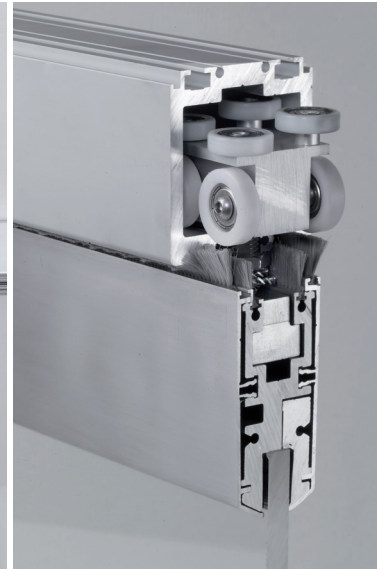
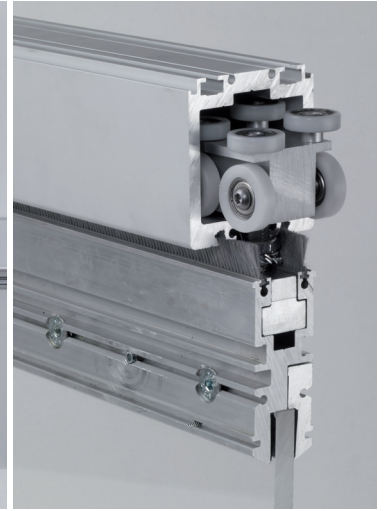
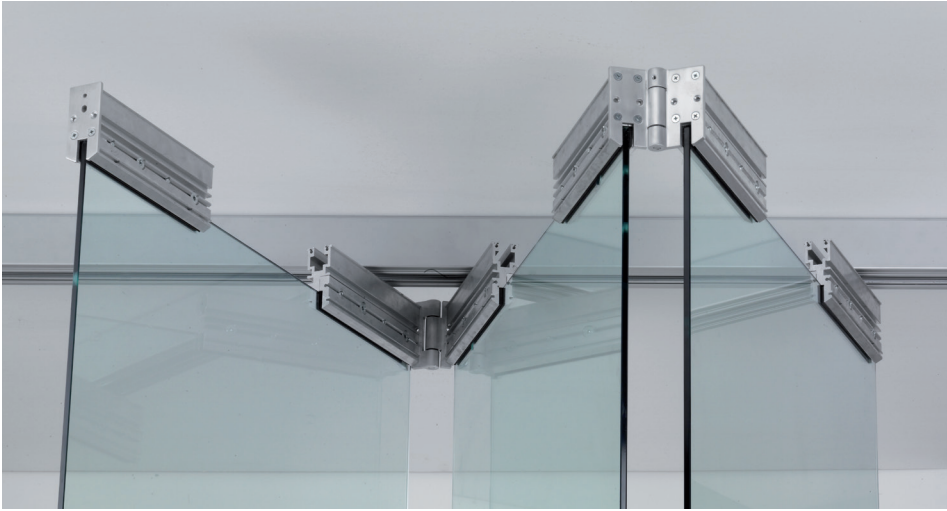

PA-100

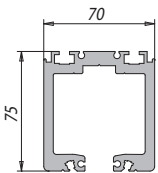

PA-113

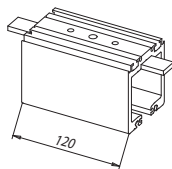

PA-201

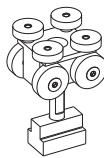

PA-205

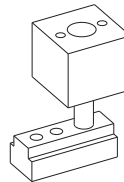

PA-206

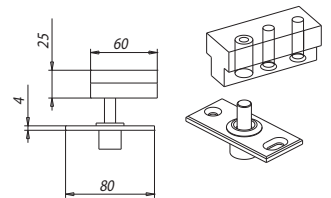

PA-221

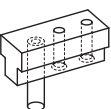

PA-222

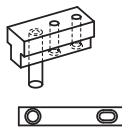

PA-420

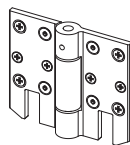

PA-411

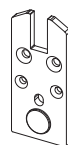

L-113
standard

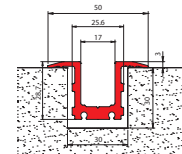

L-110
optional

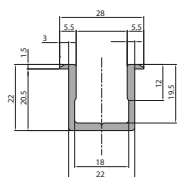

xla 334b



PA-402

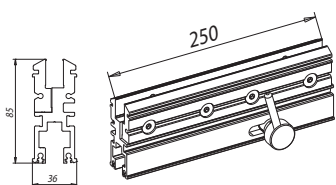

PA-430

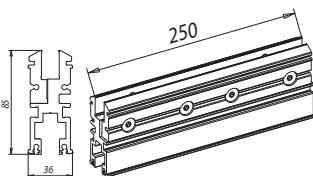

PA-404

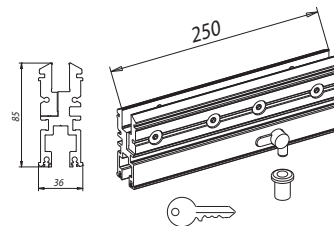

PA-408

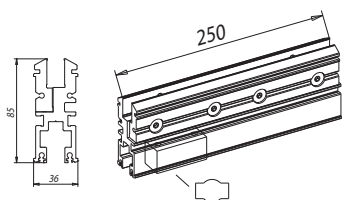

PA-407

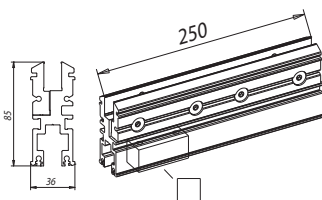

Da tagliare cliente
Adjust the length
Beliebig Kürzbar



Da tagliare cliente
Adjust the length
Beliebig Kürzbar

PA-426

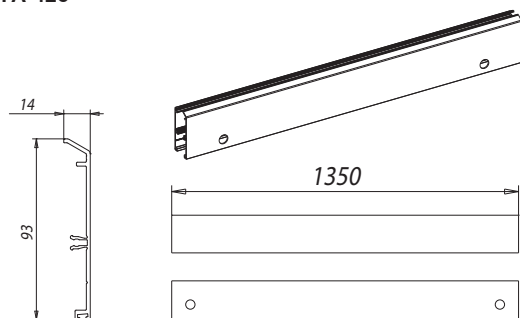

PA-425

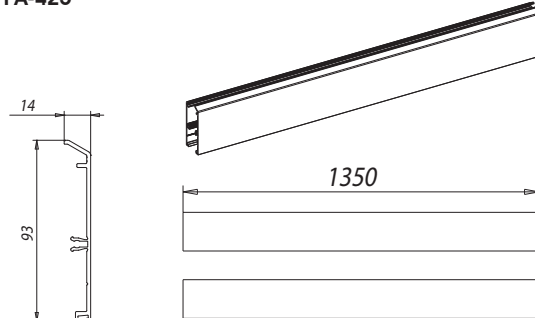

xla 334b

PA-550 Libro Folding do-it-yourself *new 2014*

Sistema scorrevole a libro con profili fermavetro continui a misura standard (mm 1200) da tagliare secondo necessità a cura del cliente, completi di catenaccioli fermaanta a posizionamento esterno regolabile. Vantaggi di una consegna più veloce e di un unico prodotto a magazzino per tutte le misure fino a 1200 mm.

Sliding folding door system with continuous glass fixing profiles of a standard size (mm 1200) to be cut on the basis of client's requirements comes equipped with an adjustable door holding latch positioned externally. The advantage of this product is quick delivery and a unique product available in the warehouse for all sizes up to 1200 mm.

Schiebesystem mit durchgehenden Glasleistenprofilen in Standardgröße (1200 mm), ablängbar, komplett mit äußeren einstellbaren Riegeln zur Flügelfeststellung. Vorteile einer raschen Lieferung und eines einzigen lagermäßigen Produktes mit Abmessungen bis 1200 mm.



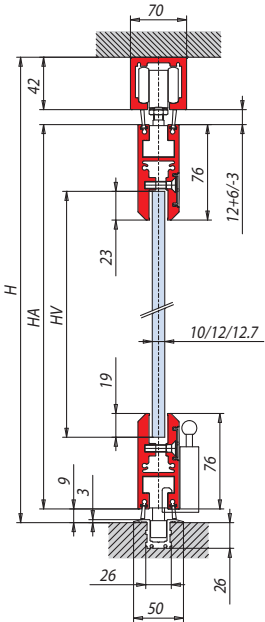
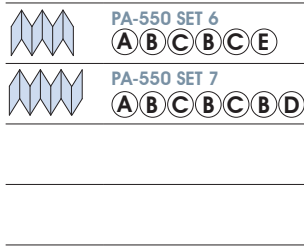
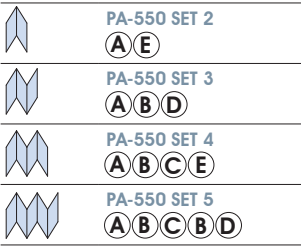

HV = H - 173
HA = H - 63

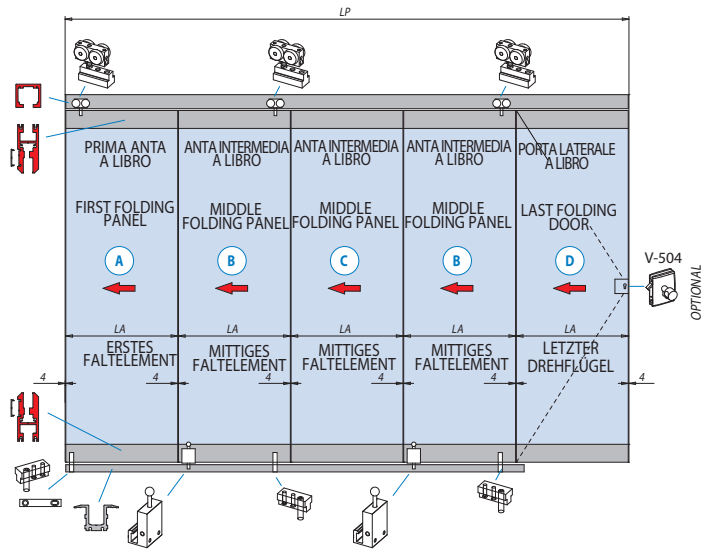

Calcolo vetro - Calculation glass - Glasberechnungen
 $At = 4 \times (N + 1)$
 $X = [\text{Luce larghezza totale (Lp) - Arie totali (At)}]$
 $X = N \times LA$
 $LA = LV = X / N$

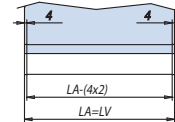
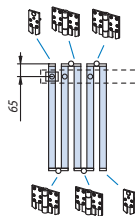
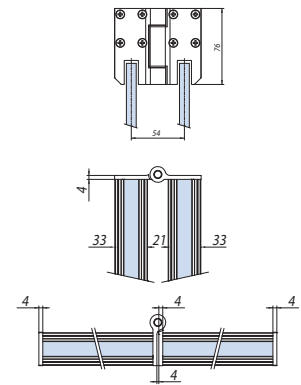
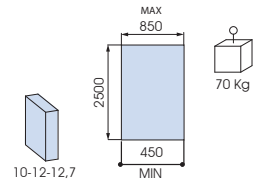

Componenti pag. 270
Components from page 270
Einzelteile Seite 270

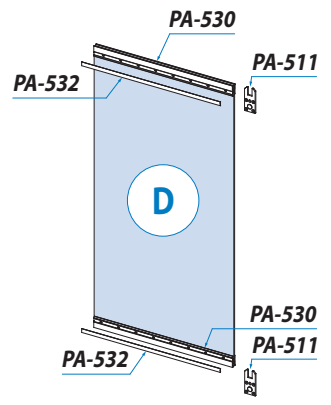
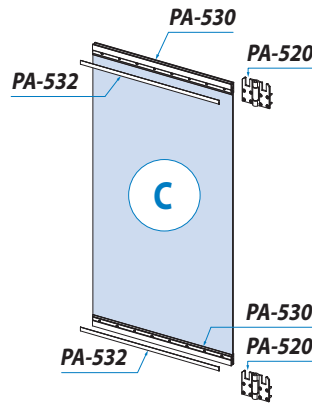
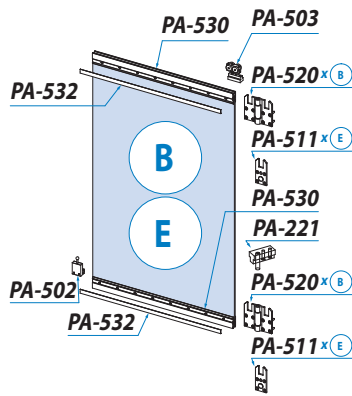
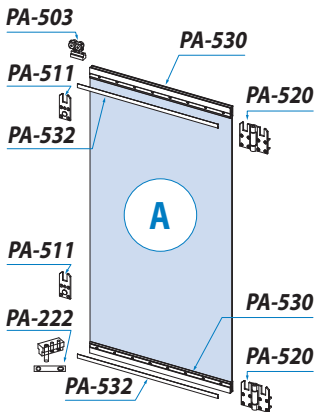

(B) Anta intermedia con catenacciolo
Middle panel with latch
Zwischenflügel mit Riegel

(E) Ultima anta con N° ante pari
Last panel with even no. panels
Letzter Flügel bei gerader Flügelanzahl

(D) Ultima anta a porta battente con n° ante dispari
Last hinged door with odd no. panels
Letzter Drehflügel bei ungerader Flügelanzahl

sla 342c

AN = Alluminio anodizzato
Aluminium anodized
Aluminium Silberfarbig

At = Arie totali
Total clearances
Summe alle Abstände Glas/Wand

N = Numero ante
Numbers panels
Anzahl der Elemente

Lp = Luce larghezza passaggio totale
Clear opening width
Lichte Durchgangsbreite

LA = LV Larghezza ante = Larghezza vetro
Panel width = Glass width
Flügelbreite = Glasbreite

H = Altezza passaggio luce
Clear opening height
Lichte Durchgangshöhe

HV = Altezza vetro
Glass height
Glashöhe

PA-550 Libro Folding do-it-yourself *new 2014*

Componenti
Components
Einzelteile

SCORREVOLI A LIBRO
SLIDING FOLDING SYSTEMS



L-150

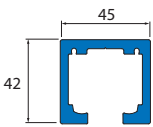

PA-503

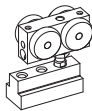

PA-206

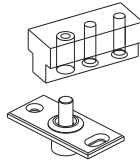
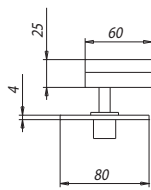

PA-221

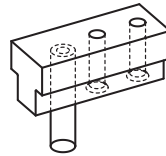

PA-222

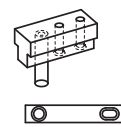

PA-502
standard

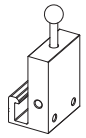

PA-504

A scatto optional 2014
Optional clicking latch 2014
Optional Riegel
mit Feder 2014

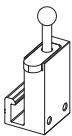

PA-509

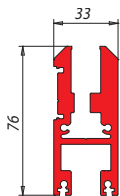

PA-510

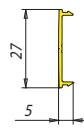

PA-520

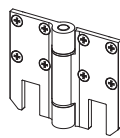

PA-511

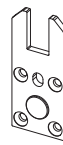

L-113
standard

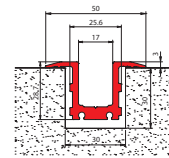

L-110
optional

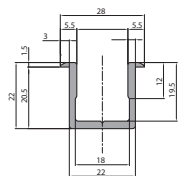



Da tagliare cliente
Adjust the length
Beliebig Kürzbar



Da tagliare cliente
Adjust the length
Beliebig Kürzbar

PA-530

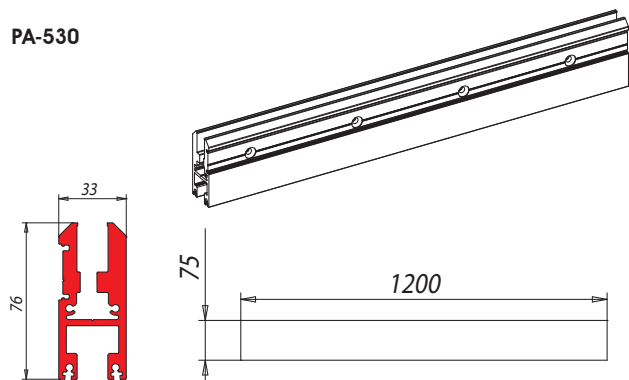

PA-532

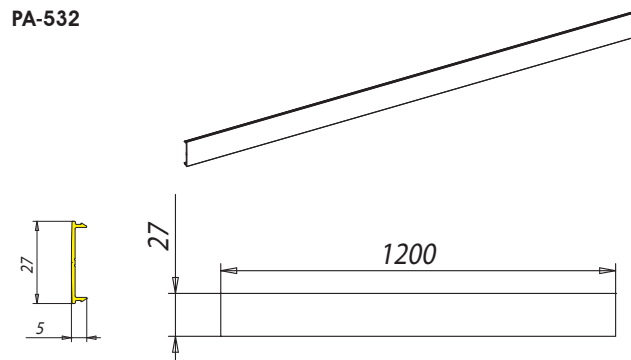

xla 341 / xla 342b

L-1000 Libro Folding

Sistema scorrevole a libro con cerniere a vista e fori nel vetro, completo di binario standard h=75 mm x L=70 mm e carrello con 8 ruote.

Sliding folding door system with visible hinges and holes in glass, including standard rail h=75 mm x L=70 mm and carriage with 8 wheels.

Faltschiebewandssystem mit sichtbaren Bändern und Glasbohrungen, komplett mit Standard-Laufschiene h=75 mm x L=70 mm und Laufwagen mit 8 Rädern.

SCORREVOLI A LIBRO
SLIDING FOLDING SYSTEMS



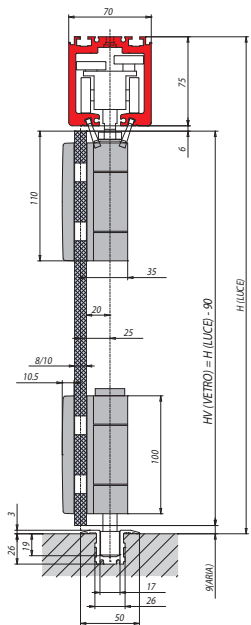

$HV = H - 90$

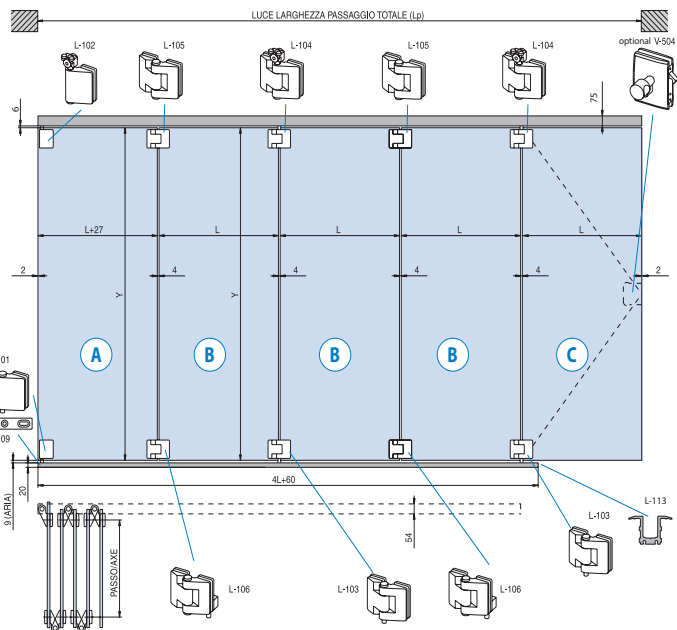
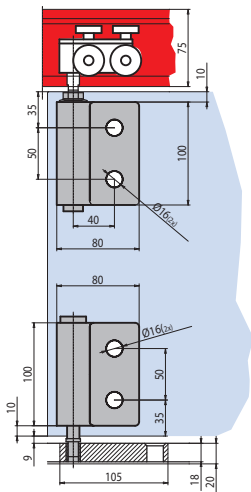

Calcolo vetro - Calculation glass - Glasberechnungen
 N° ANTE PARI - EVEN NO. PANELS - GERADE FLÜGELANZAHL
 $At = 4 \times N$
 $X = LP - At$
 $X = (LxN) + (27x2)$
 $L = (X-54) / N$

N° ANTE DISPARI - ODD NO. PANELS - UNGERADE FLÜGELANZAHL
 $At = 4 \times N$
 $X = LP - At$
 $X = (LxN) + (27x2)$
 $L = (X-27) / N$

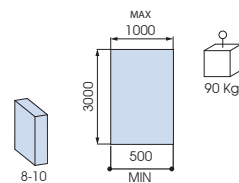
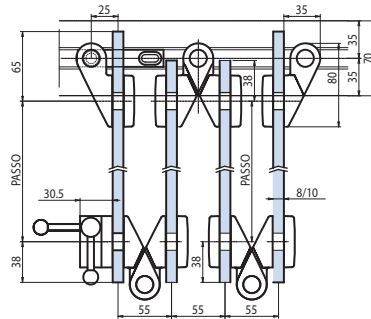

- L-1000 SET 1 (A D)
- L-1000 SET 2 (A B C)
- L-1000 SET 3 (A B B D)
- L-1000 SET 4 (A B B B C)
- L-1000 SET 5 (A B B B B D)

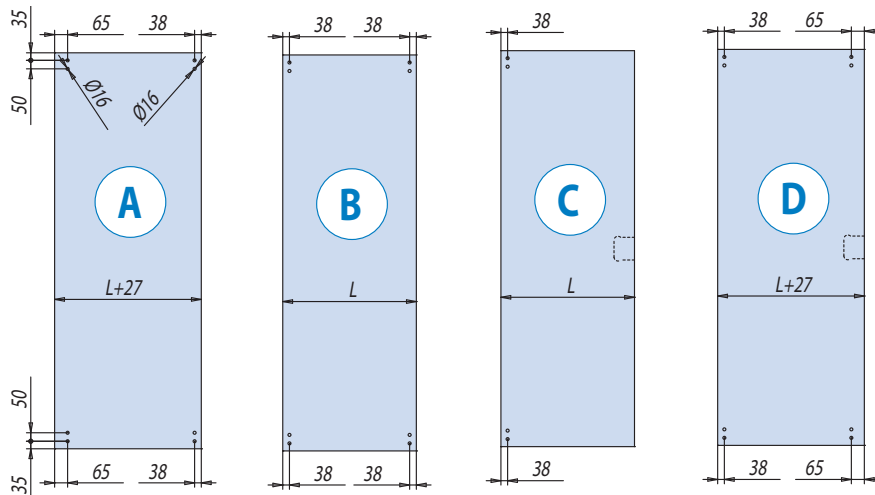

xla 342c

AN = Alluminio anodizzato Aluminium anodized Aluminium Silberfarbig	At = Arie totali Total clearances Summe alle Abstände Glas/Wand	Lp = Luce larghezza passaggio totale Clear opening width Lichte Durchgangsbreite	H = Altezza passaggio luce Clear opening height Lichte Durchgangshöhe
NS = Nichel satinato Satin nickel Ähnlich Edelstahl matt	N = Numero ante Numbers panels Anzahl der Elemente	LA = LV Larghezza ante = Larghezza vetro Panel width = Glass width Flügelbreite = Glasbreite	HV = Altezza vetro Glass height Glashöhe

L-1500 Libro Folding

Sistema scorrevole a libro con cerniere a vista e fori nel vetro, completo di binario standard h=42 mm x L=45 mm e carrello con 4 ruote.

Sliding folding door system with visible hinges and holes in glass, including standard rail h=42 mm x L=45 mm and carriage with 4 wheels.

Faltschiebewandssystem mit sichtbaren Bändern und Glasbohrungen, komplett mit Standard-Laufschiene h=42 mm x L=45 mm und Laufwagen mit 4 Rädern.

SCORREVOLI A LIBRO
SLIDING FOLDING SYSTEMS



Scorrevoli a soffietto

Senza guida a terra

Centre folding sliding systems without floor rail

Falt-Schiebewandsysteme mit mittiger Faltung ohne Bodenführung

SCORREVOLI A LIBRO
SLIDING FOLDING SYSTEMS

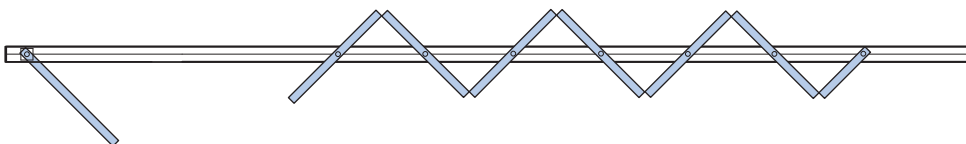

PA-260 Central Folding

(pag. 278)

Sistema a soffietto con impacchettamento centrale fornito con profili a misura richiesta dal cliente, senza fori nel vetro né guida a terra, e completo di binario standard $h=75\text{ mm} \times L=70\text{ mm}$ e carrello con 8 ruote.
Folding door system with central fold with profiles in sizes requested by the client, without holes in the glass and without bottom guide channel, and including rail $h=75\text{ mm} \times L=70\text{ mm}$ and carriage with 8 wheels.
Faltschiebewandsystem mit mittiger Faltung, kundenspezifische Profile, ohne Glasbohrungen und Bodenführung, komplett mit Laufschiene $h=75\text{ mm} \times L=70\text{ mm}$ und Laufwagen mit 8 Rädern

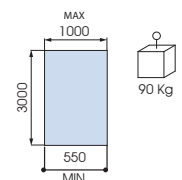
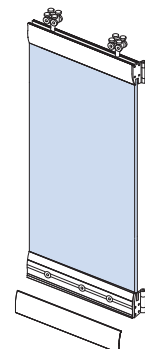
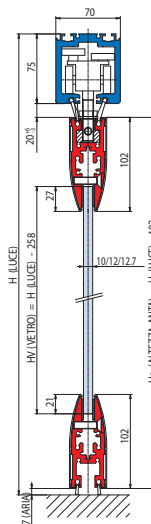

PA-460 Central folding do-it-yourself

(pag. 282)

Sistema modulare a soffietto con impacchettamento centrale completo di morsetti fermavetro (mm 250), veletta continua (mm 1200) da tagliare secondo necessità a cura del cliente, binario standard h=75 mm x L=70 mm e carrello con 8 ruote. Vantaggi di una consegna più veloce e di un unico prodotto a magazzino per tutte le misure fino a 1200 mm.
Folding door system with central fold with glass fixing clamps (mm 250) and continuous covers (mm 1200) to be cut on the basis of client's requirements, and including standard rail standard h=75 mm x L=70 mm and carriage with 8 wheels. The advantage of this product is quick delivery and a unique product available in the warehouse for all sizes up to 1200 mm.
Faltschiebewandssystem mit mittiger Faltung, Glashalteklammern(250 mm), kontinuierlicher Verkleidung (1200 mm) kundenspezifisch ablängbar, Standardlaufschiene h=75 mm x L=70 mm und Laufwagen mit 8 Rädern. Vorteile einer raschen Lieferung und eines einzigen lagermäßigen Produktes mit Abmessungen bis 1200 mm.

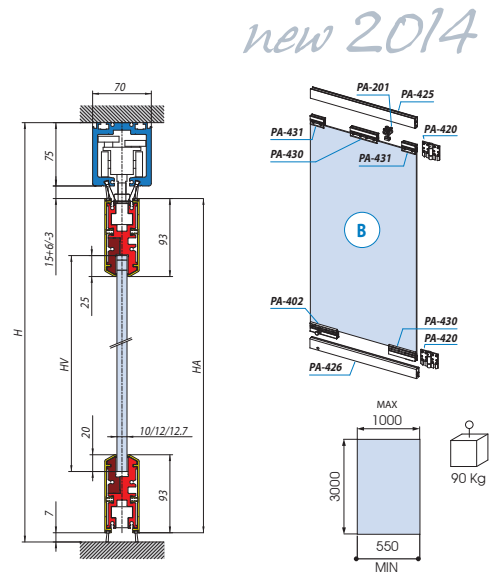

PA-560 Central folding do-it-yourself

(pag. 286)

Sistema a soffietto con profili fermavetro continui a misura standard (mm 1200) da tagliare secondo necessità a cura del cliente, completi di catenaccioli fermaanta a posizionamento esterno regolabile, binario standard h=42 mm x L=45 mm e carrello con 4 ruote. Vantaggi di una consegna più veloce e di un unico prodotto a magazzino per tutte le misure fino a 1200 mm.
Folding door system with central fold, with continuous glass fixing profiles of a standard size (mm 1200) to be cut on the basis of client's requirements, comes equipped with an adjustable door holding latch positioned externally, including standard rail h=42 mm x L=45 mm and carriage with 4 wheels. The advantage of this product is quick delivery and a unique product available in the warehouse for all sizes up to 1200 mm.
Faltschiebewandssystem mit zentraler Faltung mit durchgehenden Glasleistenprofilen in Standardgröße (1200 mm) ablängbar, komplett mit äußeren einstellbaren Riegeln zur Flügel feststellung, Laufschiene h=42 mm x L=45 mm und Laufwagen mit 4 Rädern. Vorteile einer raschen Lieferung und eines einzigen lagermäßigen Produktes mit Abmessungen bis 1200 mm.

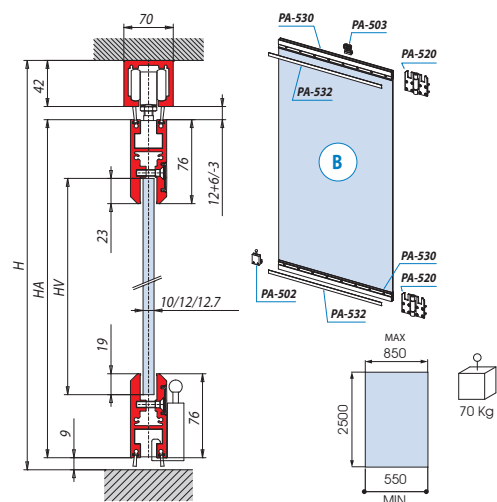

L-2500 Central Folding

(pag. 290)

Sistema a soffietto con impacchettamento centrale, cerniere a vista e fori nel vetro, completo di binario standard h=42 mm x L=45 mm e carrello con 4 r.
Centre folding system, visible hinges and holes in glass, including rail h=42 mm x L=45 mm and carriage with 4 wheels.
Faltschiebewandssystem mit mittiger Faltung, mit sichtbaren Bändern und Glasbohrungen, komplett mit Laufschiene h=42 mm x L=45 mm und Laufwagen mit 4 Rädern.

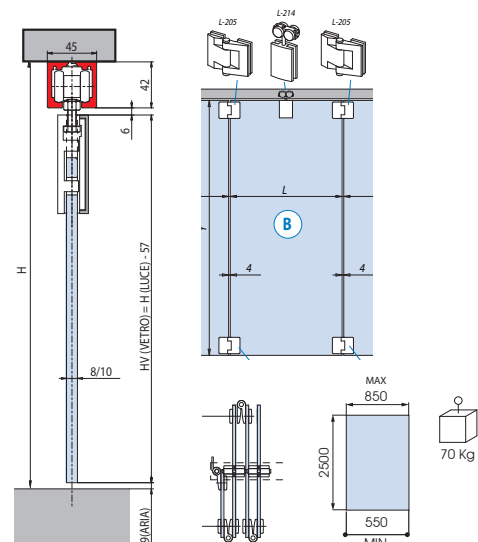
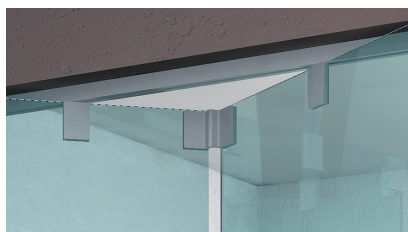







PA-260 Central Folding

Sistema a soffietto con impacchettamento centrale fornito con profili a misura richiesta dal cliente, senza fori nel vetro né guida a terra, e completo di binario standard $h=75\text{ mm} \times L=70\text{ mm}$ e carrello con 8 ruote.

Folding door system with central fold with profiles in sizes requested by the client, without holes in the glass and without bottom guide channel, and including rail $h=75\text{ mm} \times L=70\text{ mm}$ and carriage with 8 wheels.

Faltschiebewandssystem mit mittiger Faltung, kundenspezifische Profile, ohne Glasbohrungen und Bodenführung, komplett mit Laufschiene $h=75\text{ mm} \times L=70\text{ mm}$ und Laufwagen mit 8 Rädern.



	PA-260 SET 2		PA-260 SET 6
	PA-260 SET 3		PA-260 SET 7
	PA-260 SET 4		
	PA-260 SET 5		



SCORREVOLI A LIBRO
SLIDING FOLDING SYSTEMS

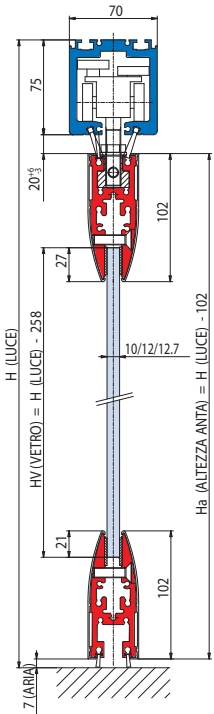

HV = H - 258
HA = H - 102

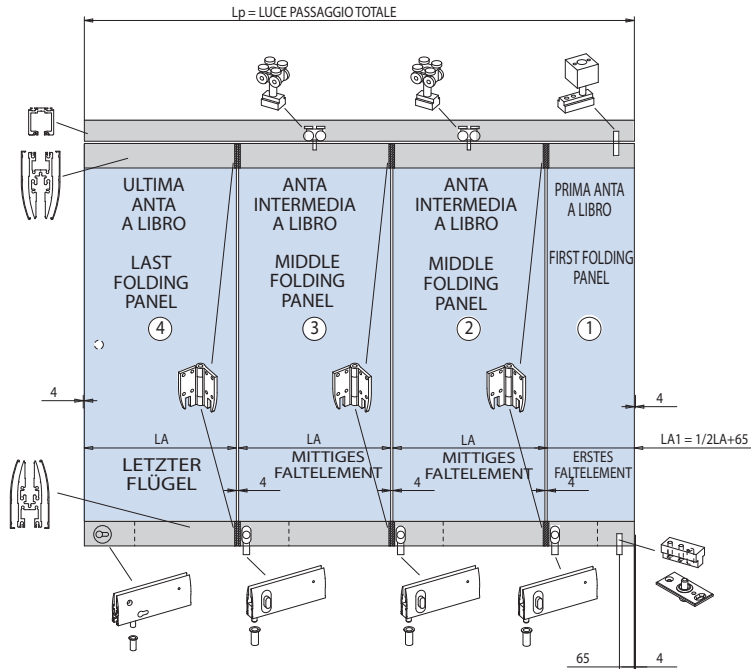

Calcolo vetro - Calculation glass - Glasberechnungen
 $A_t = 4 \times (N + 1)$
 $X = (N - 0,5) \times LA + 65$
 $X = N \times LA$
 $LA = LV = (X - 65) / (N - 0,5)$
 $LA1 = LV1 = \frac{1}{2}LA + 65$

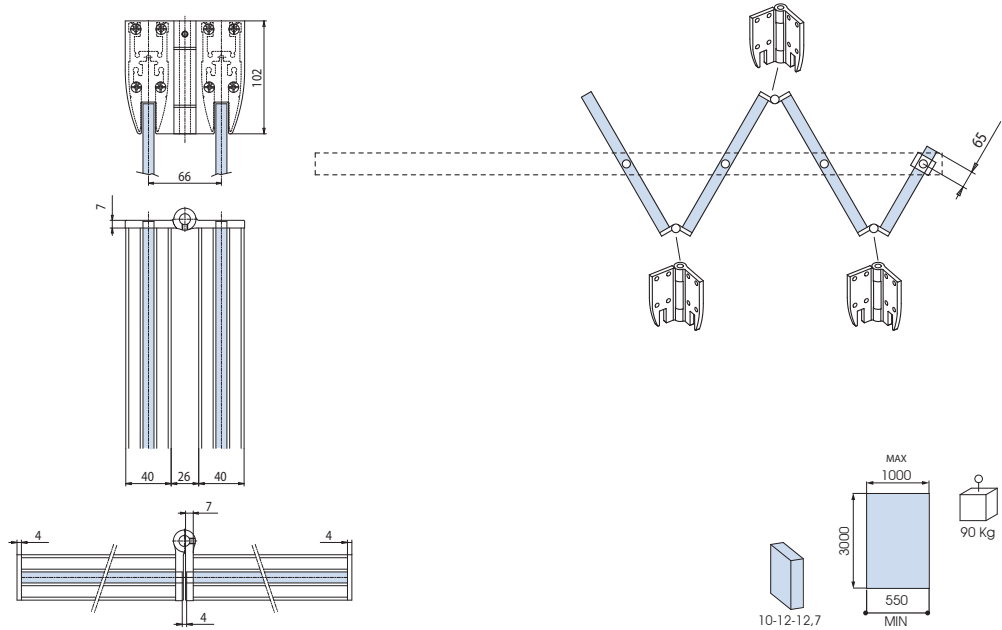

Componenti pag. 280
Components from page 280
Einzelteile Seite 280

xla 172b

AN = Alluminio anodizzato
Aluminium anodized
Aluminium Silberfarbig

At = Arie totali
Total clearances
Summe alle Abstände Glas/Wand
N = Numero ante
Numbers panels
Anzahl der Elemente

Lp = Luce larghezza passaggio totale
Clear opening width
Lichte Durchgangsbreite
LA = LV Larghezza ante = Larghezza vetro
Panel width = Glass width
Flügelbreite = Glasbreite

H = Altezza passaggio luce
Clear opening height
Lichte Durchgangshöhe
HV = Altezza vetro
Glass height
Glashöhe

PA-260 Central Folding

Componenti
Components
Einzelteile

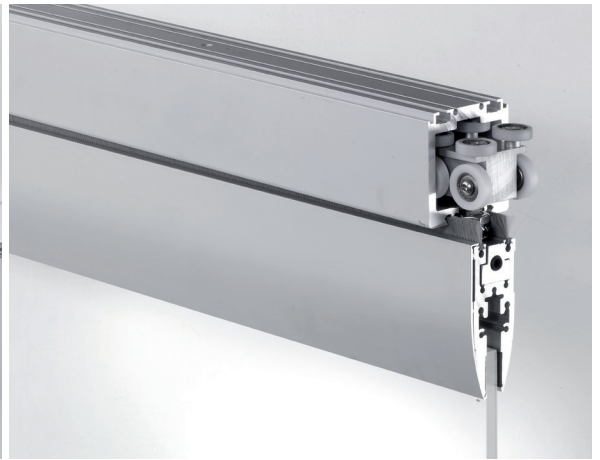

PA-100

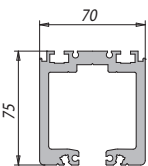

PA-113

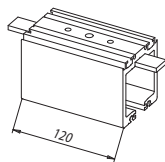

PA-201

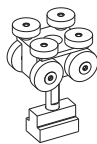

PA-205

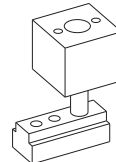

PA-206

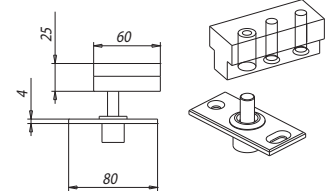

PA-220

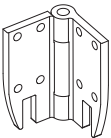

PA-215

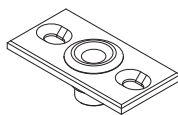

PA-211



PA-212



L-112-PA

Pozzetti non inclusi nel set
Floor sockets not included in set
Bodenbuchse nicht in set enthalten

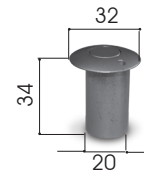

PA-203

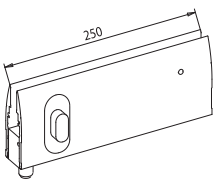

PA-204

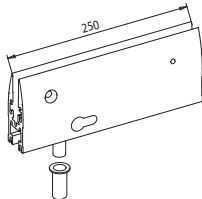

PA-207

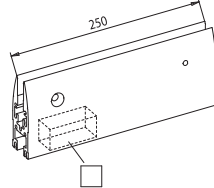

PA-208

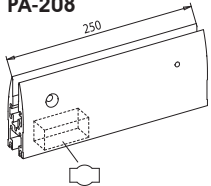

PA-209

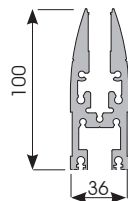

PA-210

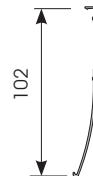

xla 333



PA-460 Central Folding do-it-yourself *new 2014*

Sistema modulare a soffietto con impacchettamento centrale completo di morsetti fermavetro (mm 250), veletta continua (mm 1200) da tagliare secondo necessità a cura del cliente, binario standard h=75 mm x L=70 mm e carrello con 8 ruote. Vantaggi di una consegna più veloce e di un unico prodotto a magazzino per tutte le misure fino a 1200 mm.

Folding door system with central fold with glass fixing clamps (mm 250) and continuous covers (mm 1200) to be cut on the basis of client's requirements, and including standard rail standard h=75 mm x L=70 mm and carriage with 8 wheels. The advantage of this product is quick delivery and a unique product available in the warehouse for all sizes up to 1200 mm.

Faltschiebewandssystem mit mittiger Faltung, Glashalteklammern(250 mm), kontinuierlicher Verkleidung (1200 mm) kundenspezifisch abkläglich, Standardlaufschiene h=75 mm x L=70 mm und Laufwagen mit 8 Rädern. Vorteile einer raschen Lieferung und eines einzigen lagermäßigen Produktes mit Abmessungen bis 1200 mm.





	PA-260 SET 2 (A D)
	PA-260 SET 3 (A B C)
	PA-260 SET 4 (A B B C)
	PA-260 SET 5 (A B B B C)

	PA-460 SET 5 (A B B B B C)
--	--------------------------------------

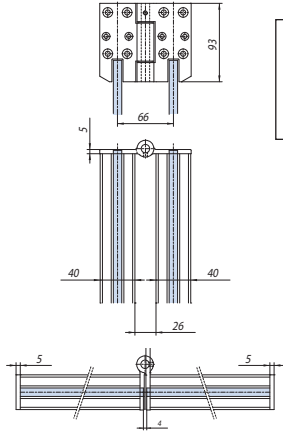
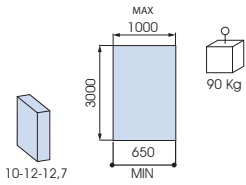
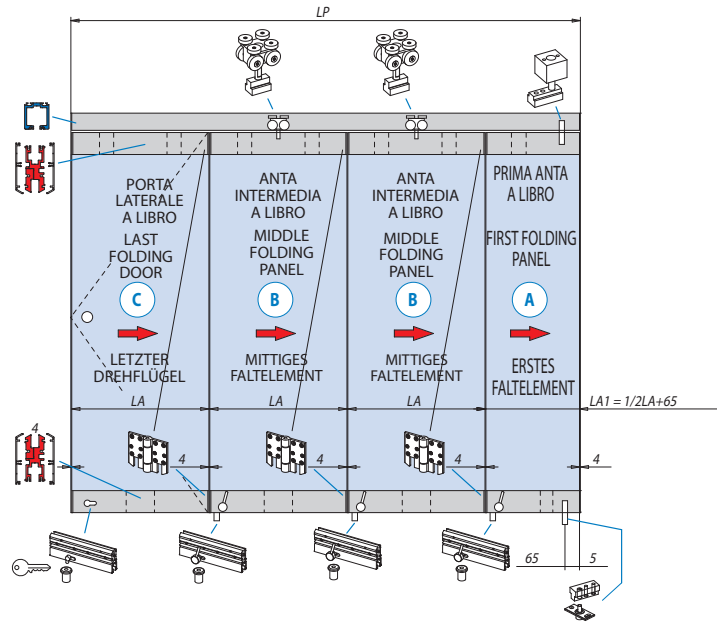
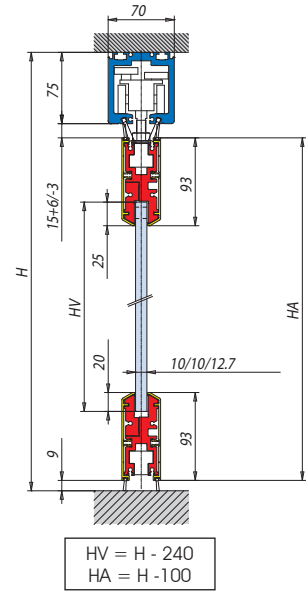

Calcolo vetro - Calculation glass - Glasberechnungen
 $A_t = 4 \times (N + 1)$
 $X = L_p - A_t$
 $X = (N - 0,5) \times LA + 65$
 $LA = LV = (X - 65) / (N - 0,5)$
 $LA1 = LV1 = 1/2LA + 65$

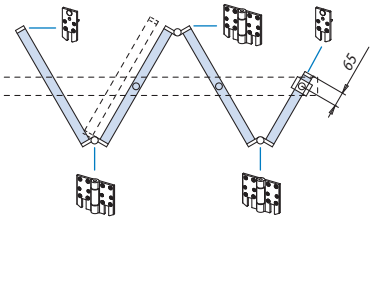

Componenti pag. 284
 Components from page 284
 Einzelteile Seite 284

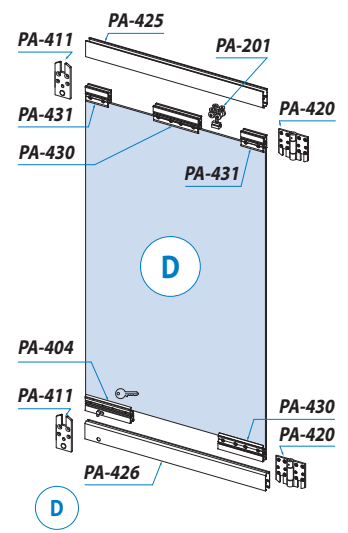
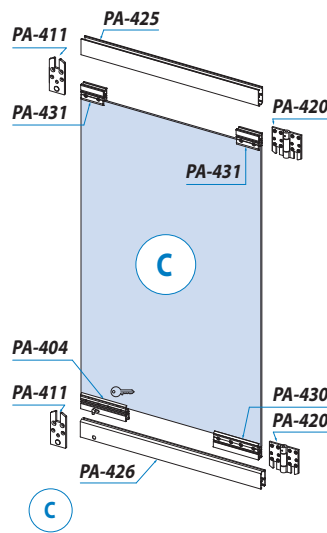
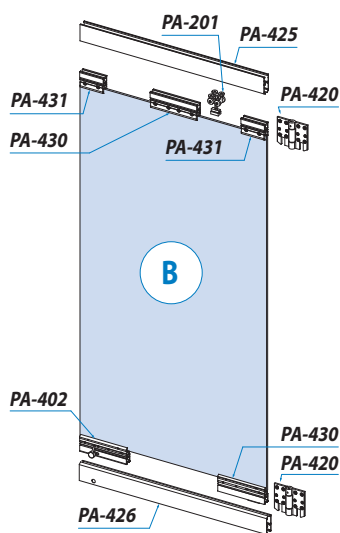
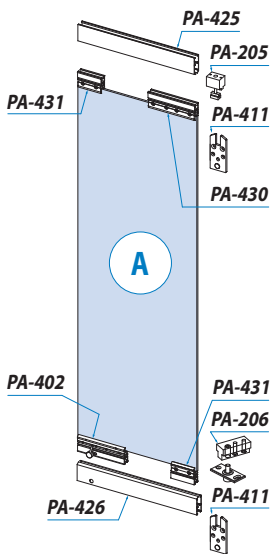

xla 334e

AN = Alluminio anodizzato
 Aluminium anodized
 Aluminium Silberfarbig

A_t = Arie totali
 Total clearances
 Summe alle Abstände Glas/Wand
 N = Numero ante
 Numbers panels
 Anzahl der Elemente

L_p = Luce larghezza passaggio totale
 Clear opening width
 Lichte Durchgangsbreite
 LA = LV Larghezza ante = Larghezza vetro
 Panel width = Glass width
 Flügelbreite = Glasbreite

H = Altezza passaggio luce
 Clear opening height
 Lichte Durchgangshöhe
 HV = Altezza vetro
 Glass height
 Glashöhe

PA-460 Central Folding do-it-yourself *new 2014*

Componenti
Components
Einzelteile

SCORREVOLI A LIBRO
SLIDING FOLDING SYSTEMS

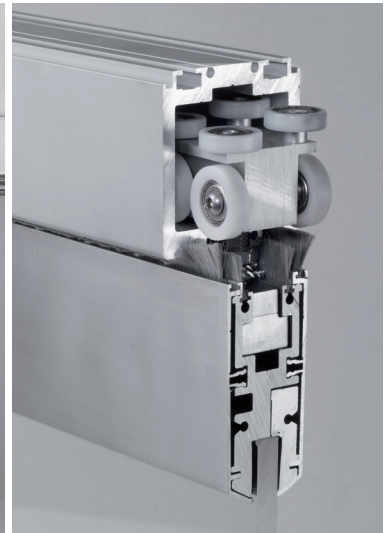
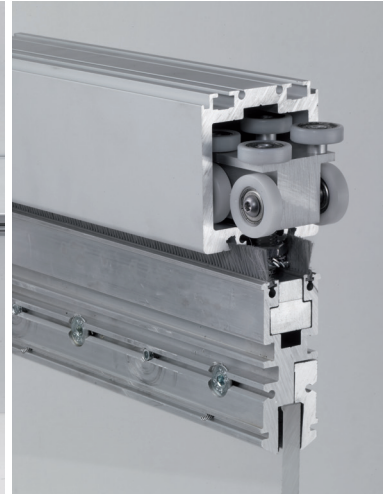
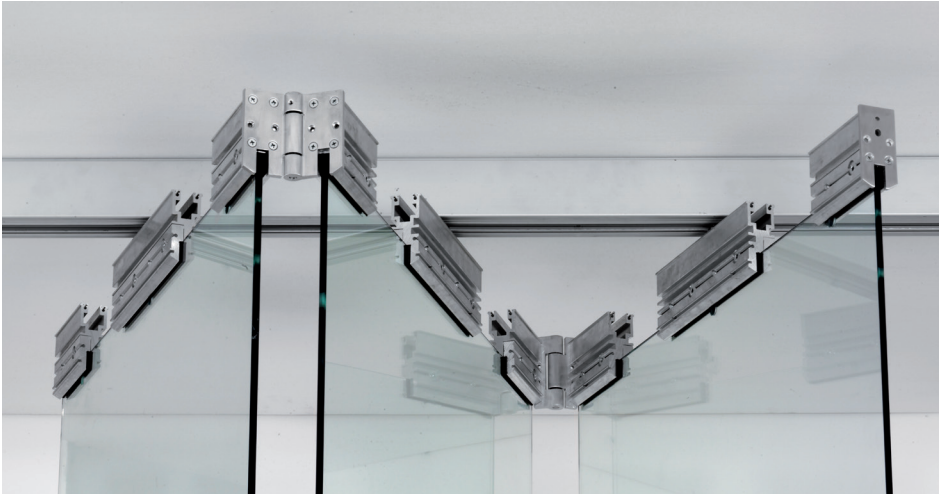

PA-100

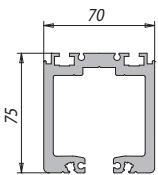

PA-113

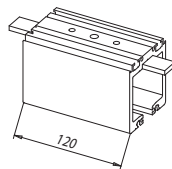

PA-201

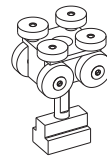

PA-205

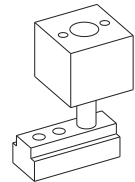

PA-206

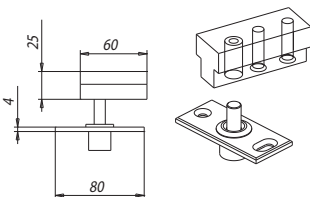

PA-420

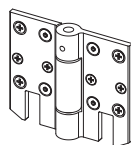

PA-411

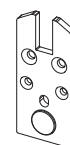

L-112-PA

Pozzetti non inclusi nel set
Floor sockets not included in set
Bodenbuchse nicht in set enthalten

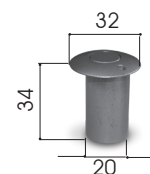



PA-430

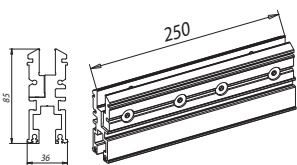

PA-402

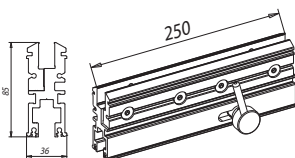

PA-431

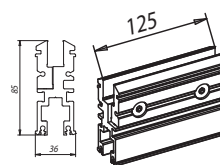

PA-408

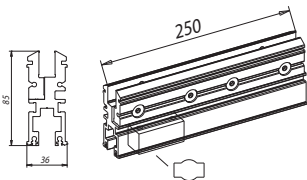

PA-407

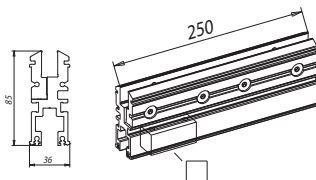

PA-404

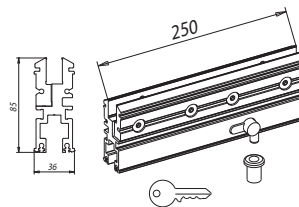

Da tagliare cliente
Adjust the length
Beliebig Kürzbar

PA-425

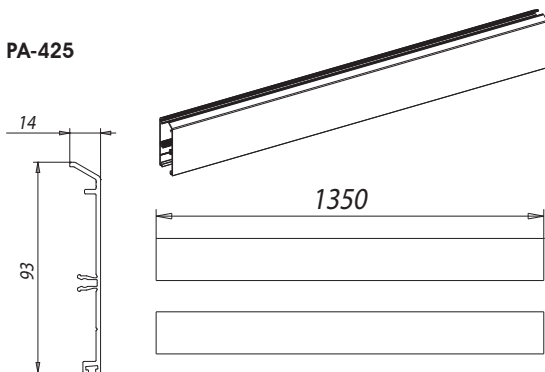

Da tagliare cliente
Adjust the length
Beliebig Kürzbar

PA-426

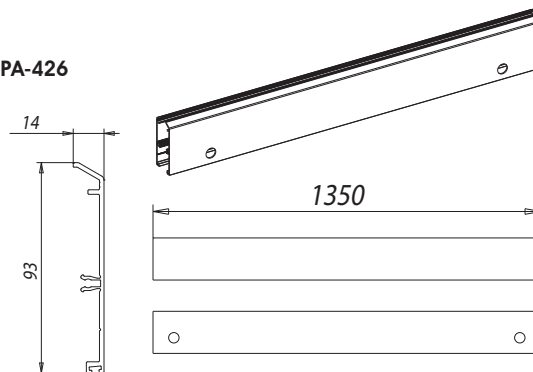

xla 333 / xla 334b

PA-560 Central Folding do-it-yourself *new 2014*

Sistema a soffietto con profili fermavetro continui a misura standard (mm 1200) da tagliare secondo necessità a cura del cliente, completi di catenaccioli fermaanta a posizionamento esterno regolabile, binario h=42 mm x L=45 mm e carrello con 4 ruote. Vantaggi di una consegna più veloce e di un unico prodotto a magazzino per tutte le misure fino a 1200 mm.

Folding door system with central fold, with continuous glass fixing profiles of a standard size (mm 1200) to be cut on the basis of client's requirements, comes equipped with an adjustable door holding latch positioned externally, including rail h=42 mm x L=45 mm and carriage with 4 wheels. The advantage of this product is quick delivery and a unique product available in the warehouse for all sizes up to 1200 mm.

Faltschiebewandssystem mit zentraler Faltung mit durchgehenden Glasleistenprofilen in Standardgröße (1200 mm) ablingbar, komplett mit äußeren einstellbaren Riegeln zur Flügelfeststellung, Laufschiene h=42 mm x L=45 mm und Laufwagen mit 4 Rädern. Vorteile einer raschen Lieferung und eines einzigen lagermäßigen Produktes mit Abmessungen bis 1200 mm.





	PA-560 SET 1 (A D)
	PA-560 SET 2 (A B C)
	PA-560 SET 3 (A B B C)
	PA-560 SET 4 (A B B B C)

	PA-560 SET 5 (A B B B B C)
--	--------------------------------------

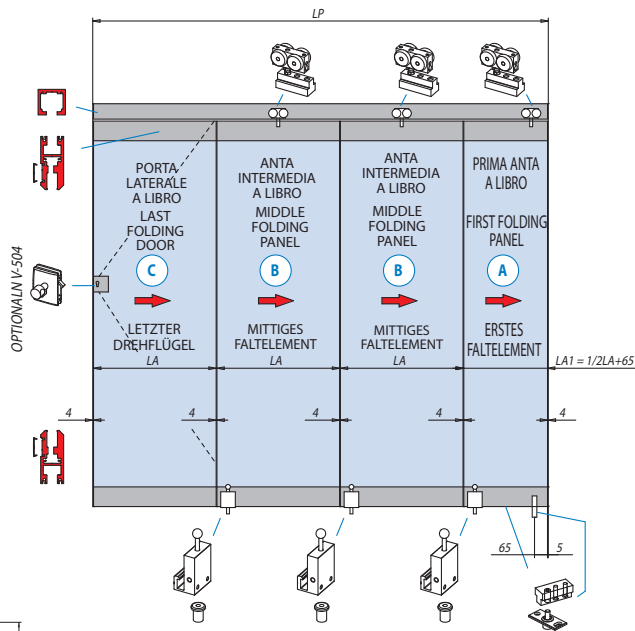
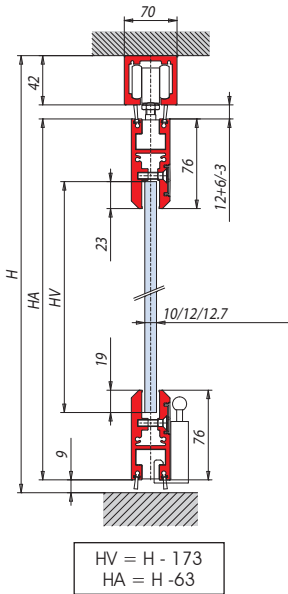

Calcolo vetro - Calculation glass - Glasberechnungen
 $At = 4 \times (N + 1)$
 $X = Lp - At$
 $X = (N - 0,5) \times LA + 65$
 $LA = LV \times (X - 65) / (N - 0,5)$
 $LA1 = LV1 = 1/2LA + 65$

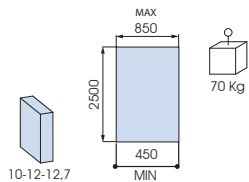

Componenti pag. 288
 Components from page 288
 Einzelteile Seite 288

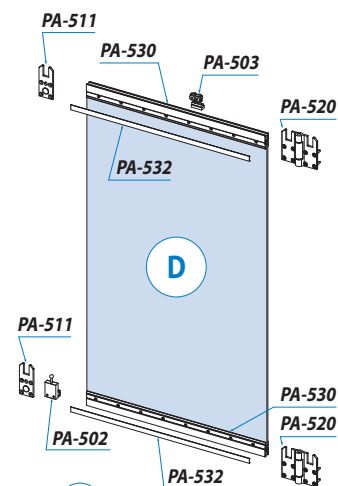
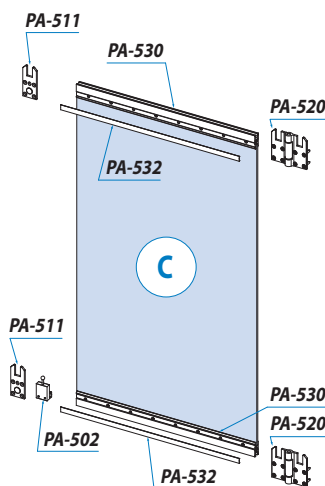
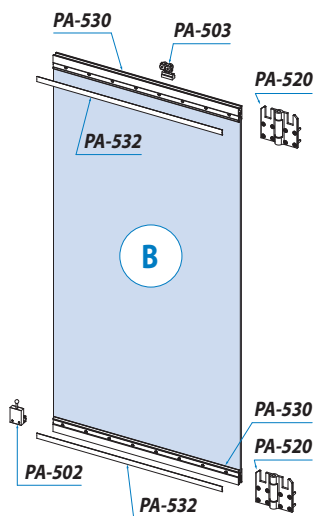
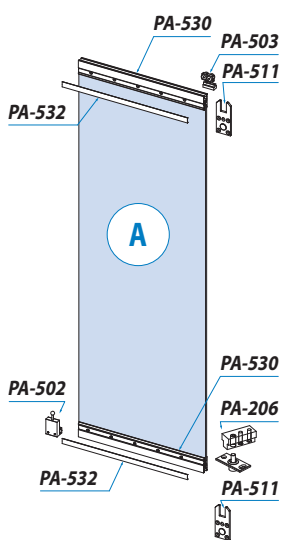
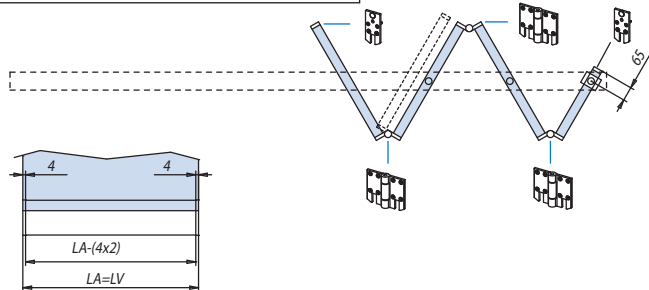
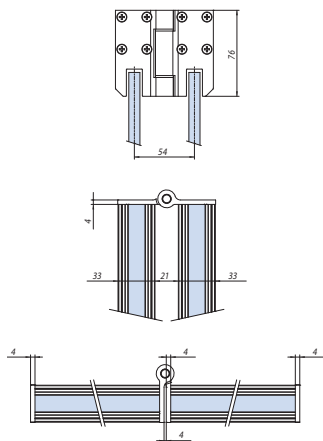

C Ultima ante a porta battente
 Last folding swing door
 Letzter Flügel als Dreh-/Fallflügel

D Ultima ante a libro
 Last folding panel
 Letzter Flügel als Fallflügel

xla 342f

AN = Alluminio anodizzato
 Aluminium anodized
 Aluminium Silberfarbig

At = Arie totali
 Total clearances
 Summe alle Abstände Glas/Wand
 N = Numero ante
 Numbers panels
 Anzahl der Elemente

Lp = Luce larghezza passaggio totale
 Clear opening width
 Lichte Durchgangsbreite
 LA = LV Larghezza ante = Larghezza vetro
 Panel width = Glass width
 Flügelbreite = Glasbreite

H = Altezza passaggio luce
 Clear opening height
 Lichte Durchgangshöhe
 HV = Altezza vetro
 Glass height
 Glashöhe

PA-560 Central Folding do-it-yourself *new 2014*

Componenti
Components
Einzelteile

SCORREVOLI A LIBRO
SLIDING FOLDING SYSTEMS

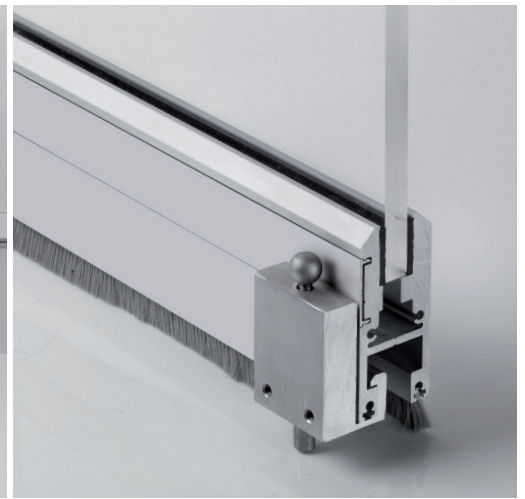

L-150

PA-503

PA-206

PA-502
standard

PA-504

A scatto optional 2014
Optional clicking latch 2014
Optional Riegel
mit Feder 2014

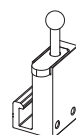
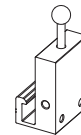
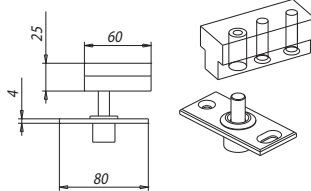
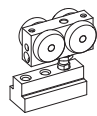
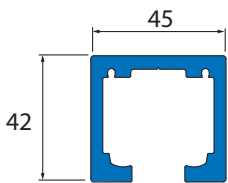

PA-509

PA-510

PA-520

PA-511

L-512-PA

Pozzetti non inclusi nel set
Floor sockets not included in set
Bodenbuchse nicht in set
enthalten

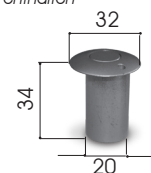
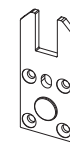
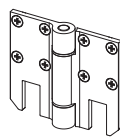
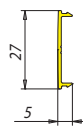
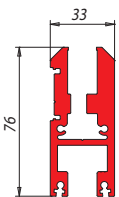



Da tagliare cliente
Adjust the length
Beliebig Kürzbar

PA-530

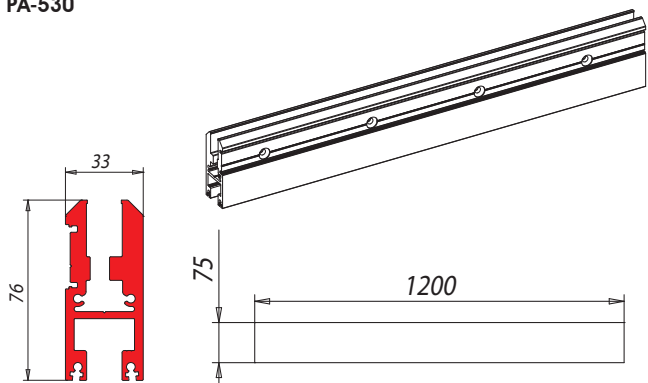

Da tagliare cliente
Adjust the length
Beliebig Kürzbar

PA-532

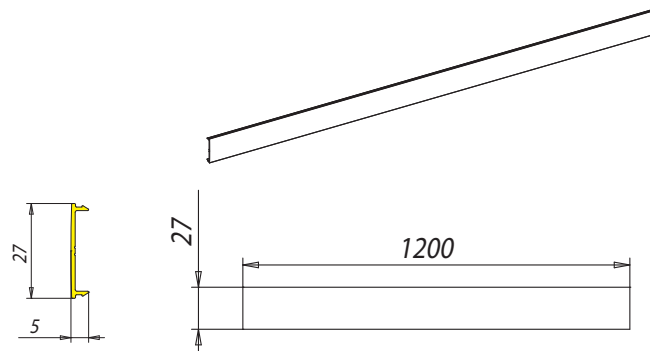

xla 341 / xla 342