



# MANUFAKTUR

Qualität aus Leidenschaft · Quality built on Passion



TÜRSYSTEME · DOOR SYSTEMS

 **MWE**<sup>®</sup>  
Edelstahlmanufaktur GmbH

EDITION IX

Klassik Seite/page 6    Supra S./p 6    ProTec S./p 7    Spider S./p 8    Chronos S./p 9    Duplex S./p 10



Duplex S S./p 10    Vario S./p 12    Twin S./p 14    Akzent R S./p 16    Purist S./p 17



Terra S./p 18    Terra H S./p 18    Terra Akzent S./p 19    Terra M S./p 20    Terra M XL S./p 21



Akzent S./p 22    Akzent R S./p 23    Akzent R S./p 23    Agitus S./p 24



Langstangen- & Kurzstangenset Long rod and short rod    Drückergarnitur Opener hardware    Schlosskasten | Lock case    Pendeltürband | Helical hinge

Stiletgriffe | Stiletto handles S./p 25    Türgriffe | Door handles S./p 26



Zubehör | Accessories S./p 30



**Credits**  
 Product design: Mario Wille, MWE Edelstahlmanufaktur GmbH  
 Catalogue layout/realization: Thilo Schulz  
 MWE Edelstahlmanufaktur GmbH, 2013. All rights reserved.  
 Product design and texts are protected by European copyright laws.  
 Any reproduction or use of these texts or parts thereof requires the express written permission of MWE Edelstahlmanufaktur GmbH.

**Kurzbeschreibung Symbole**  
 Description of symbols

Mit Hilfe der Symbole bekommen Sie eine schnelle Übersicht über die Zusatzfunktionen und Einsatzmöglichkeiten der einzelnen Türsysteme. The symbols give you a quick overview of the extra features and application options for each door system.



Mögliches Material und Stärke des Türblatts  
 Possible door material and thickness

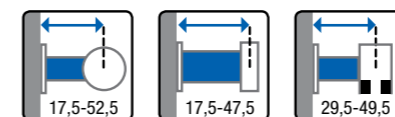

Variable Wandabstände der Schiebetüren  
 Variable wall clearances for sliding doors

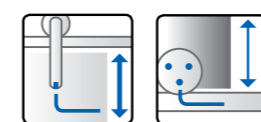

Höhenverstellung der Tür nach Montage möglich  
 Height adjustable after mounting



Mit MWE-Soft-Stop-Technik lieferbar  
 MWE soft stop technology available

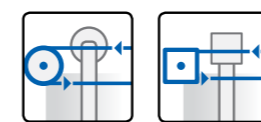

Lieferbar mit Synchronsteuertechnik  
 Synchronous technology available



Maximales Türblattgewicht  
 Maximum door weight

**Impressum**  
 Produktdesign: Mario Wille, MWE Edelstahlmanufaktur GmbH  
 MWE Edelstahlmanufaktur GmbH, 2013. Alle Rechte vorbehalten.  
 Produktdesign, Bilder und Texte sind urheberrechtlich geschützt.  
 Jede Verwendung der Bilder, Texte oder Teile derselben bedarf der ausdrücklichen schriftlichen Genehmigung der MWE Edelstahlmanufaktur GmbH.

Schiebetürsysteme Rollwagen oben  
 Sliding Door Systems Top Roller

Klassik	6
Supra	6
ProTec	7
Spider	8
Chronos	9
Duplex	10
Duplex S	10
Vario	12
Twin	14
Akzent R	16
Purist	17

Schiebetürsysteme Rollwagen unten  
 Sliding Door Systems Bottom Roller

Terra	18
Terra H	18
Terra Akzent	19
Terra M	20
Terra M XL	21

Drehtürbeschläge | Pivoting Doors

Akzent Lang- und Kurzstange   Akzent long and short rod	22
Drückergarnitur Akzent R   Akzent R opener hardware	23
Schlosskasten Akzent R   Akzent R lock case	23
Pendeltürband Agitus   Agitus helical hinge	24

Türgriffe | Door handles

Stiletgriffe   Stiletto handles	25
Stangengriffe   Straight door handles	26
Griffmuscheln   Flush pulls	29

Zubehör | Accessories

MWE-Soft-Stop-Technik   MWE soft stop technology	30
Synchronsteuertechnik   Synchronous technology	31
Zubehör   Accessories	32
Die Manufaktur   Manufactory	34

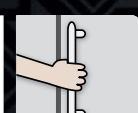
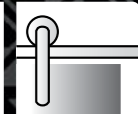



TOP ROLLER  
**ROLLWAGEN OBEN**

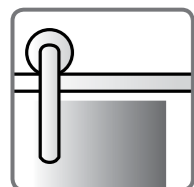

MWE bietet 11 klassische Schiebetürsysteme mit oben laufenden Rollwagen an. Die Laufschiene wird hierbei an einer Wand oder Decke befestigt. Auf dem Boden befindet sich lediglich eine kurze Bodenführung, welche das Türblatt bei der Bewegung lotrecht eng an der Wand führt.

MWE offers 11 classic sliding door systems with top rollers. The runner rail is attached to either the wall or ceiling. On the floor is only a short floor guide that keeps the door leaf plumb and steers it closely along the wall.



BOTTOM ROLLER  
**ROLLWAGEN UNTEN**

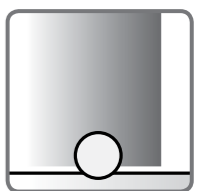

Die 5 wählbaren Terra-Systeme übertragen das Gewicht der Schiebetür direkt auf den Boden. Am oberen Ende der Tür wird die Anlage über ein durchgehendes Führungsprofil sicher in der Spur gehalten.

The 5 available Terra systems transfer the weight of the sliding door directly to the floor. A continuous guide profile keeps the upper edge of the door securely on track.

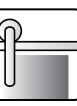

## KLASSIK ST.1000.KL

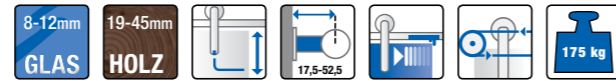

+ Einfache Wartung und Montage durch umfangreiche Einstellmöglichkeiten + Hervorragende Laufeigenschaften durch Laufschiene aus Vollmaterial + Geeignet für Türblätter aus Glas, Holz, Metall und Kunststoff + Hohe Objektauglichkeit durch drei Punkthalter + Lieferbar mit **MWE-Soft-Stop-Technik** und Synchrontechnik + Türblattgewicht bis 175 kg

+ Easy maintenance and installation thanks to extensive adjustment options + Runs smoothly thanks to rail of solid material + Suitable for glass, wood, metal or plastic door leaves + Available with **MWE soft stop technology** and synchronous technology + Door leaf weight up to 175 kg

## PROTEC ST.1016.PR

+ Einfache Wartung und Montage durch umfangreiche Einstellmöglichkeiten + Hervorragende Laufeigenschaften durch Laufschiene aus Vollmaterial + Geeignet für Türblätter aus Glas, Holz, Metall und Kunststoff + Lieferbar mit **MWE-Soft-Stop-Technik** und Synchrontechnik + Türblattgewicht bis 105 kg

+ Easy maintenance and installation thanks to extensive adjustment options + Runs smoothly thanks to rail of solid material + Suitable for door leaves of glass, wood, metal or plastic + Available with **MWE soft stop technology** and synchronous technology + Door leaf weight up to 105 kg

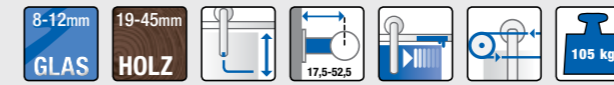

## SUPRA ST.1009.SU

+ Geeignet für Holz- oder Spiegeltüren + Befestigung auf Türblattoberkante + Für Türblattstärken zwischen 19 und 90 mm + Lieferbar mit **MWE-Soft-Stop-Technik** und Synchrontechnik + Türblattgewicht bis 135 kg

+ Suitable for wood or mirrored doors + Rollers fixed to the top edge of door leaf + For door thicknesses between 19 and 90 mm + Available with **MWE soft stop technology** and synchronous technology + Door leaf weight up to 135 kg



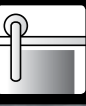

*Premium Edition*

## SPIDER ST.1033.SP

+ Hervorragende Laufeigenschaften durch Laufschiene aus Vollmaterial + Geeignet für Türblätter aus Glas, Holz, Metall und Kunststoff + Hohe Objekttauglichkeit durch drei Punkthalter + Lieferbar mit **MWE-Soft-Stop-Technik** und Synchron-technik + Türblattgewicht bis 205 kg

+ Runs smoothly thanks to rail of solid material + Suitable for glass, wood, metal or plastic door leaves + Ideal stability for public areas due to three point holders + Available with **MWE soft stop technology** and synchronous technology + Door leaf weight up to 205 kg

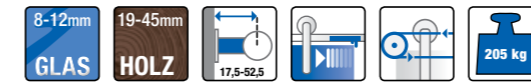
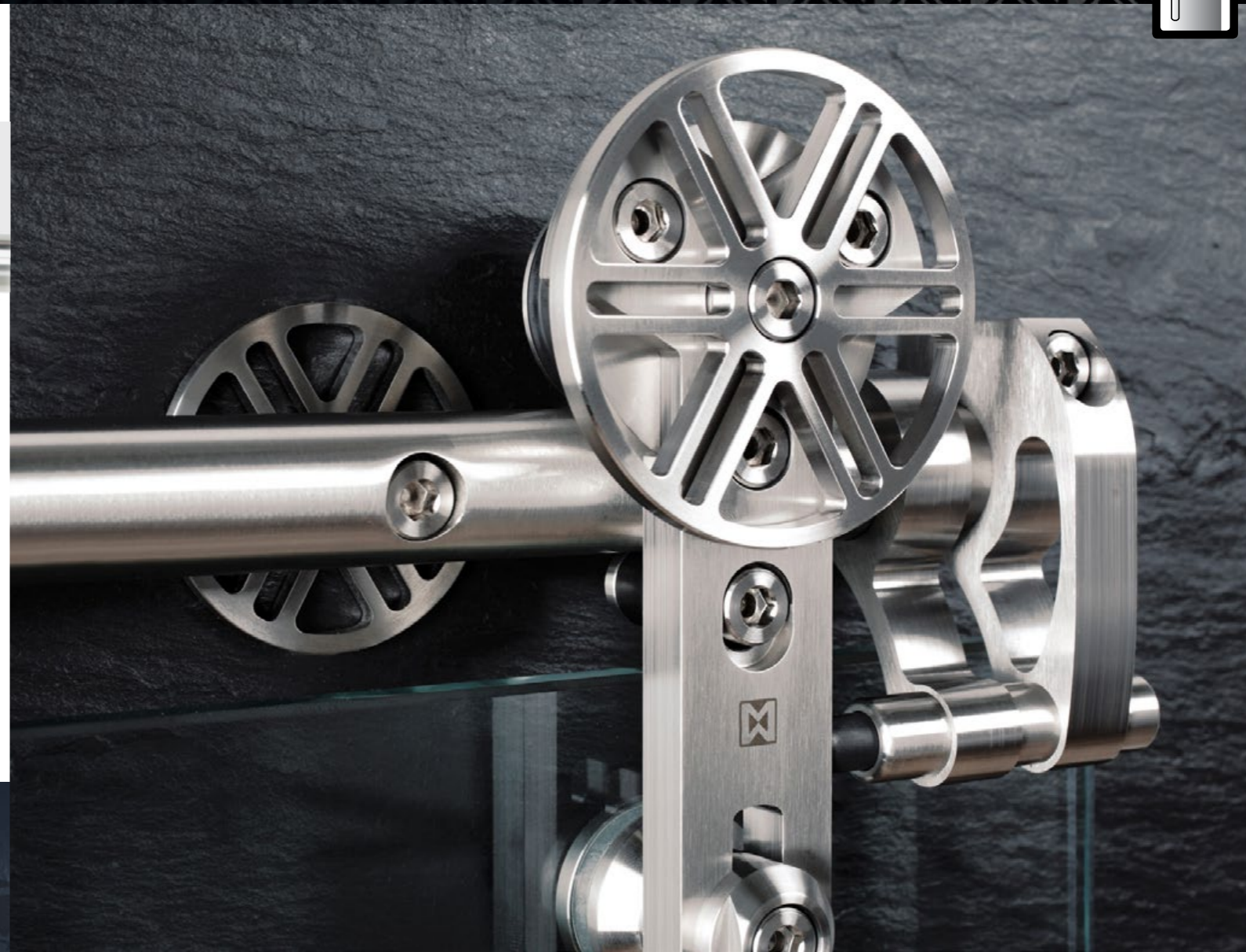
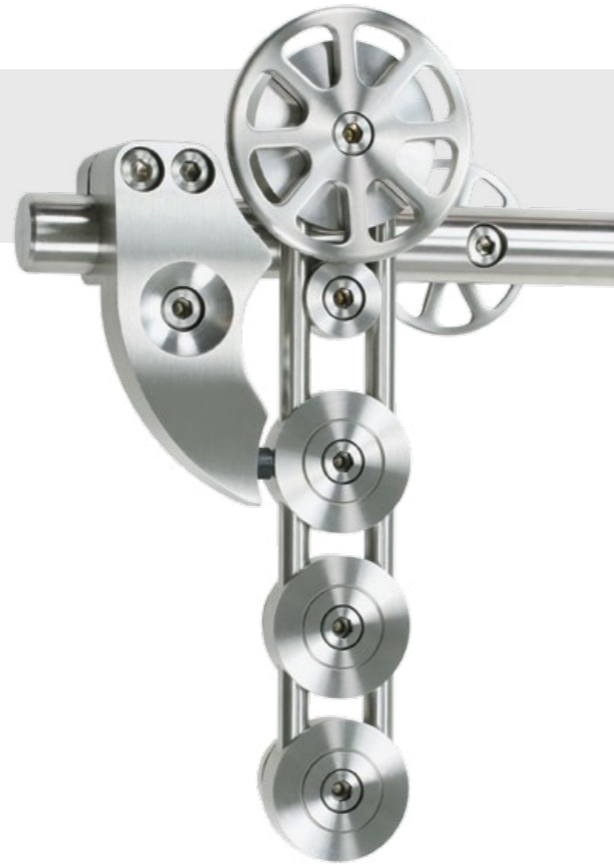
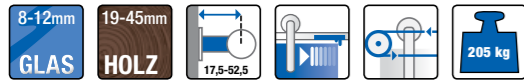

*Premium Edition*

## CHRONOS ST.1030.CH

+ Hervorragende Laufeigenschaften durch Laufschiene aus Vollmaterial + Geeignet für Türblätter aus Glas, Holz, Metall und Kunststoff + Hohe Objekttauglichkeit durch drei Punkthalter + Lieferbar mit **MWE-Soft-Stop-Technik** und Synchron-technik + Türblattgewicht bis 205 kg

+ Runs smoothly thanks to rail of solid material + Suitable for glass, wood, metal or plastic door leaves + Ideal stability for public areas due to three point holders + Available with **MWE soft stop technology** and synchronous technology + Door leaf weight up to 205 kg

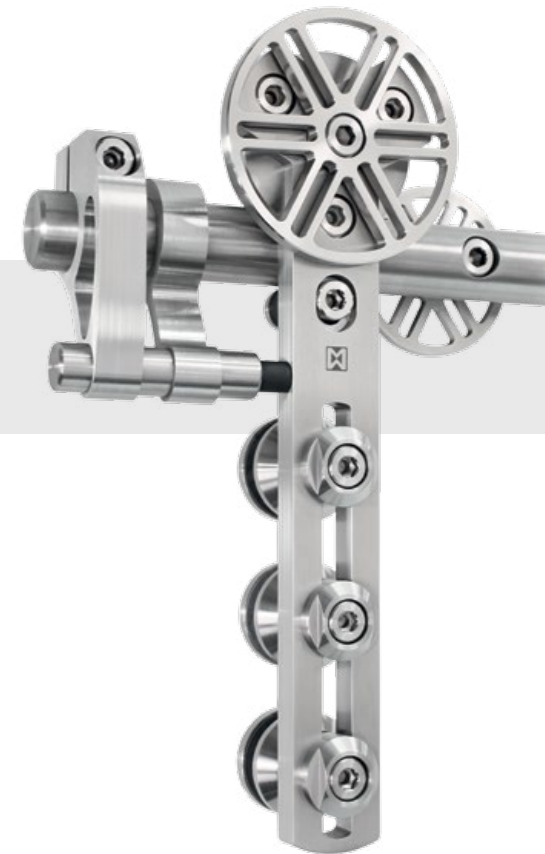

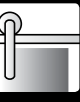

# DUPLEX ST.1007.DU

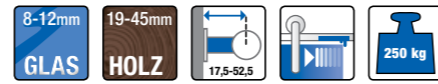

## *Premium Edition*

+ System speziell für schwere und große Türblätter + Hervorragende Laufeigenschaften durch Laufschiene aus Vollmaterial + Geeignet für Türblätter aus Glas, Holz, Metall und Kunststoff + Hohe Objekttauglichkeit durch große Punkthalter + Lieferbar mit **MWE-Soft-Stop-Technik** + Türblattgewicht bis 250 kg

+ System specially designed for large and heavy door leaves + Runs smoothly thanks to rail of solid material + Suitable for glass, wood, metal or plastic door leaves + Ideal stability for public areas due to large point holders + Available with **MWE soft stop technology** + Door leaf weight up to 250 kg



Bild zeigt hochglanzpolierte Ausführung  
Picture shows mirror-finished version

# DUPLEX S ST.1017.DS *Premium Edition*

+ Geeignet für besonders schwere Holztüren + Befestigung auf/in der Türblattoberkante + Türblattstärke zwischen 19 und 90 mm + **MWE-Soft-Stop-Technik** + Türblattgewicht bis 190 kg

+ Suitable for very heavy wood doors + Attached to or countersunk in the top edge of the door leaf + Door leaf thickness between 19 and 90 mm + **MWE soft stop technology** + Door leaf weight up to 190 kg



Bild zeigt hochglanzpolierte Ausführung  
Picture shows mirror-finished version

# DUPLEX ST.1007.DU

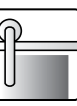

VARIO ST.1005.VA

+ Einmalige Lösung für das Bewegen von geraden Türblättern an gebogenen Wänden + System auch für gebogene Türblätter geeignet (Variante ST.1005.VAR/Radius bis min. 750 mm) + Individuelle Planung der kompletten Anlage durch MWE + Hervorragende Laufeigenschaften durch Laufschiene aus Vollmaterial + Geeignet für Türblätter aus Glas, Holz, Metall und Kunststoff + Türblattgewicht bis 135 kg

+ One-of-a-kind solution for sliding straight doors along curved walls + System also suitable for curved door leaves (variant ST.1005.VAR/ radius up to min. 750 mm) + Custom planning of the complete system by MWE + Runs smoothly thanks to rail of solid material + Suitable for glass, wood, metal or plastic door leaves + Door leaf weight up to 135 kg



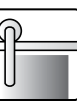

## TWIN ST.1011.TW

+ System speziell für raumhohe Türelemente + verschiedene Deckenhalter lieferbar + Auch für Montage an Wand geeignet + Hervorragende Laufeigenschaften durch Laufschiene aus Vollmaterial + Geeignet für Türblätter aus Glas, Holz, Metall und Kunststoff + Türblattgewicht bis 135 kg

+ System specially designed for floor-to-ceiling door panels + Various ceiling holders available + Also suitable for wall mounting + Runs smoothly thanks to rail of solid material + Suitable for glass, wood, metal or plastic door leaves + Door leaf weight up to 135 kg



Bild zeigt hochglanzpolierte Ausführung  
Picture shows mirror-finished version



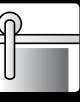

PURIST ST.1055.PU *Premium Edition*

+ System komplett ohne sichtbare Verschraubungen (Senkpunkthalter/magnetische Abdeckungen) + Besonders leichte Reinigung der Beschläge (Ideal für z.B. Krankenhäuser, Arztpraxen, usw.) + Laufschiene und Zubehörteile komplett aus massivem Flachprofil gefertigt + Lieferbar mit **MWE-Soft-Stop-Technik** + Kann für alternative Glasstärken mit normalen Glaspunkthaltern bestellt werden (Standard sind Senkpunkthalter) + Geeignet für Türblätter aus Glas, Holz, Metall und Kunststoff + Türblattgewicht bis 135 kg

+ System without visible screw connections (countersunk point holders/ magnetic covers) + Hardware especially easy to clean (ideal for e.g. hospitals, medical practices, etc.) + Runner rail and hardware made completely of solid, flat-profile material + Available with **MWE soft stop technology** + Also available with normal glass point holders for alternative glass thicknesses (countersunk point holders are standard) + Suitable for glass, wood, metal or plastic door leaves + Door leaf weight up to 135 kg



AKZENT R ST.1043.AR

+ Rollwagen, Laufschiene und Zubehörteile komplett aus massivem Flachprofil gefertigt + Lieferbar mit **MWE-Soft-Stop-Technik** und Synchronsteuertechnik + Geeignet für Türblätter aus Glas, Holz, Metall und Kunststoff + Türblattgewicht bis 135 kg

+ Roller carriage, runner rail and fittings all made of solid, flat-profile material + Available with **MWE soft stop technology** and synchronous technology + Suitable for glass, wood, metal or plastic door leaves + Door leaf weight up to 135 kg

*Premium Edition*

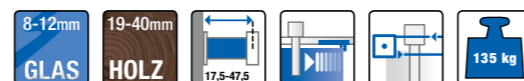



# TERRA ST.1060.TE

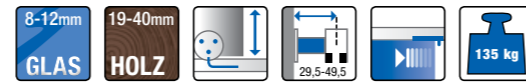

+ System mit Bodenlaufschiene + Gewicht des Türblatts wird direkt auf den Boden übertragen + Verschraubte, geklebte oder eingelassene Bodenlaufschiene lieferbar + Lieferbar mit **MWE-Soft-Stop-Technik** + Türblattgewicht bis 135 kg

+ System with floor track + Weight of door leaf is transmitted directly to the floor + Bolted, glued or flush-mounted floor track available + Available with **MWE soft stop technology** + Door leaf weight up to 135 kg



# TERRA H ST.1061.TH

+ Rollwagen zum Einlassen speziell für Holztürblätter + System mit Bodenlaufschiene + Gewicht des Türblatts wird direkt auf den Boden übertragen + Verschraubte, geklebte oder eingelassene Bodenlaufschiene lieferbar + Lieferbar mit **MWE-Soft-Stop-Technik** + Türblattgewicht bis 135 kg

+ Countersunk rollers specially designed for wood door leaves + System with floor track + Weight of door leaf is transmitted directly to the floor + Bolted, glued or flush-mounted floor track available + Available with **MWE soft stop technology** + Door leaf weight up to 135 kg

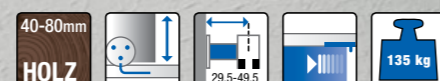

# TERRA AKZENT ST.1064.TA

+ System mit Bodenlaufschiene + Gewicht des Türblatts wird direkt auf den Boden übertragen + Durch magnetische Abdeckungen keine sichtbaren Verschraubungen + Geklebte, verschraubte oder eingelassene Bodenlaufschiene lieferbar + Geringe Spaltmaße zwischen Türblatt und Wandelement durch mittig unter der Glastür angeordnete Rollwagen + Lieferbar mit **MWE-Soft-Stop-Technik** + Türblattgewicht bis 80 kg

+ System with floor track + Weight of door leaf is transmitted directly to the floor + Magnetic covers conceal the screw connections + Glued, bolted or flush-mounted floor track available + Low clearance between door leaf and wall element due to rollers set in the middle under the glass door + Available with **MWE soft stop technology** + Door leaf weight up to 80 kg

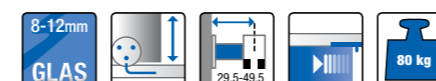

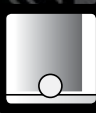

## TERRA M XL ST.1063.TXL

*Premium Edition*

+ Für extrem große und schwere **Türblätter bis zu 400 kg** + System mit Bodenlaufschiene + Gewicht des Türblatts wird direkt auf den Boden übertragen  
 + Rückseitig keine sichtbaren Verschraubungen (Rollwagen wahlweise drehbar) + Geklebte, verschraubte oder eingelassene Bodenlaufschiene lieferbar

+ For extremely large and heavy **door leaves up to 400 kg** + System with floor track + Weight of door leaf is transmitted directly to the floor  
 + No visible screw connections on the reverse (rollers can be mounted on either side) + Glued, bolted or flush-mounted floor track available

**bis 400 kg!**

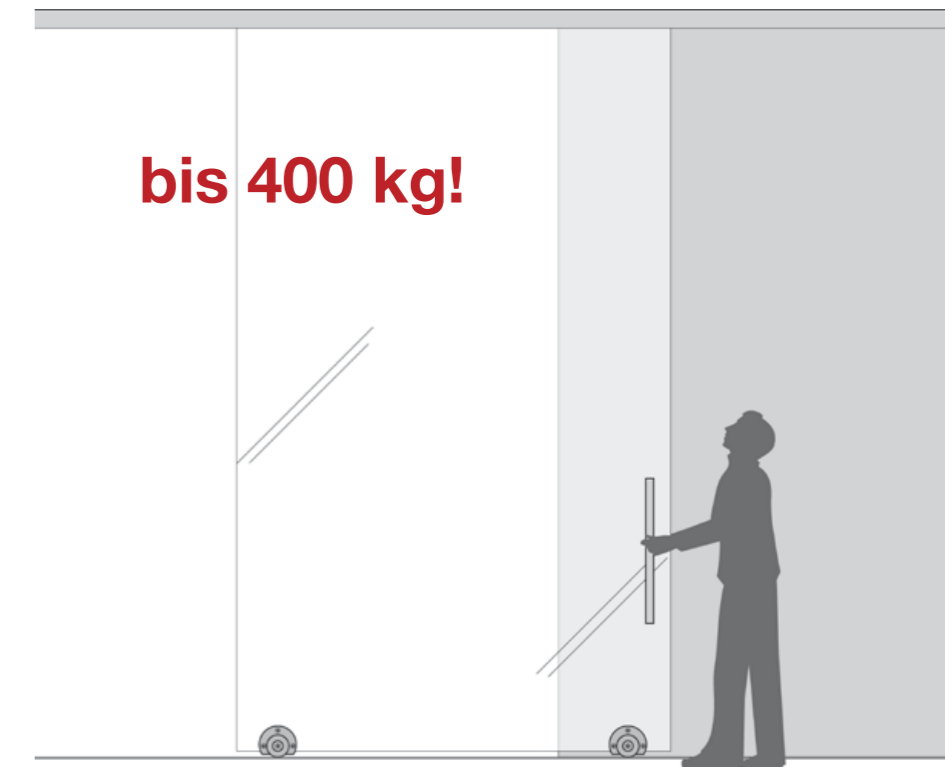

## TERRA M ST.1062.TM

*Premium Edition*

+ System mit Bodenlaufschiene + Gewicht des Türblatts wird direkt auf den Boden übertragen + Rückseitig keine sichtbaren Verschraubungen (Rollwagen wahlweise drehbar) + Geklebte, verschraubte oder eingelassene Bodenlaufschiene lieferbar + Geringe Spaltmaße zwischen Türblatt und Wandelement durch mittig unter der Glastür angeordnete Rollwagen + Lieferbar mit **MWE-Soft-Stop-Technik** + Türblattgewicht bis 155 kg

+ System with floor track + Weight of door leaf is transmitted directly to the floor + No visible screw connections on the reverse (rollers can be mounted on either side) + Glued, bolted or flush-mounted floor track available + Low clearance between door leaf and wall element due to rollers set in the middle under the glass door + Available with **MWE-soft-stop-technology** + Door leaf weight up to 155 kg

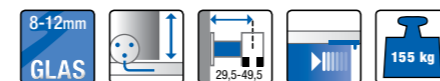

## Terra M XL

Bild zeigt hochglanzpolierte Ausführungen  
 Picture shows mirror-finished versions



Ø 178,5 mm  
 bis 400 kg Türblattgewicht  
 door weight up to 400 kg

## Terra M



Ø 119 mm  
 bis 155 kg Türblattgewicht  
 door weight up to 155 kg

Der Einsatz von Drehtüren mit individuellem Akzent gewinnt in der modernen Architektur immer mehr an Bedeutung. Mit den Drehtürbeschlägen von MWE setzen Sie klare gestalterische Zeichen. Herausragende Funktionalität und perfekte Verarbeitung halten, was das außergewöhnliche Design verspricht.

Pivoting doors with an individual touch are becoming more and more en vogue in contemporary interior design. Doors in MWE's Akzent series are a highlight in any setting. The striking design is perfectly matched by outstanding functionality and the unparalleled quality of the craftsmanship.



Bild zeigt hochglanzpolierte Ausführung  
Picture shows mirror-finished version



Drehtürsystem Akzent -  
Langstange | Akzent Pivoting  
Door System long rod  
DT.8510.AR



Drehtürsystem Akzent -  
Kurzstange | Akzent Pivoting Door  
System short rod  
DT.8560.AR

Bild zeigt hochglanzpolierte Ausführung  
Picture shows mirror-finished version

Drehtürstangen | Pivoting Door Rod Systems  
**AKZENT**



Bilder zeigen hochglanzpolierte Ausführung



Pictures shows mirror-finished version

Drückergarnitur | Opener hardware  
**AKZENT R STUDIO**



Türdrücker Akzent R Studio  
Akzent R door opener  
TD.8650.AR.L/R+TD.1400

Türband Akzent R Studio  
Akzent R door hinge  
TB.8600.AR.L/R

Ausführung mit WC-Verriegelung: TD.8650.AR.WC.L/R  
Version with bathroom lock: TD.8650.AR.WC.L/R



Bild zeigt hochglanzpolierte Ausführung  
Picture shows mirror-finished version



Schlosskasten | Lockcase  
**AKZENT R ALTUS**  
TD.2010.L/R



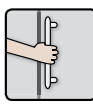

Pendeltürband | Pivot door hinge

# AGITUS



PT.7114.G  
Glasanbindung 180°  
180° glass-mounted



PT.7110.G  
Beidseitige Wandanbindung  
Two-sided wall-mounted



PT.7112.G  
Einseitige Wandanbindung  
One-sided wall-mounted

+ Alle Verschraubungen liegen elegant verdeckt hinter magnetischen Abdeckungen + Kompletter Beschlag aus Vollmaterial gefertigt + Sehr kompakte Abmaße durch elegante Slim-Line-Optik + Einfache Reinigung durch minimale Spaltmaße + Wand- und Glasanbindung lieferbar + Türblattgewicht bis 75 kg

+ All screw connections are elegantly concealed behind magnetic covers + All hardware made of solid material + Very compact dimensions with elegant slim-line look + Easy cleaning thanks to minimal clearance + Wall and glass connection available + Door leaf weight up to 75 kg.



Stiletto Griff mit Profilzylinder | Stiletto handle with profile cylinder



TG.1150.PZ

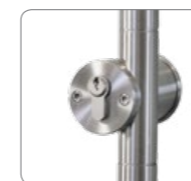

Mit durchgehendem Profilzylinder  
With continuous profile cylinder



TG.1150



Einseitig, rein mechanische Verriegelung  
Lockable from one side with mechanical lock



TG.1150.S/AK



Einseitig mit Zylinderschloss verriegelbar, viereckiges Profil  
Lockable from one side, rectangular profile

TG.1150.PZ/WC



Durchgehender Profilzylinder mit WC-Verriegelung  
Continuous profile cylinder with bathroom lock

TG.1150.S



Einseitig mit Zylinderschloss verriegelbar  
Lockable from one side with cylinder lock

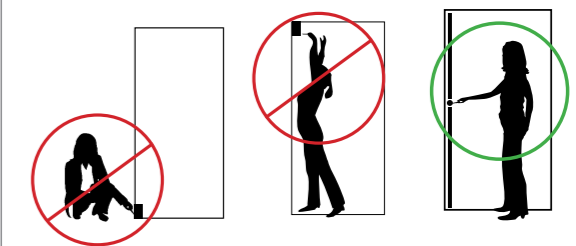
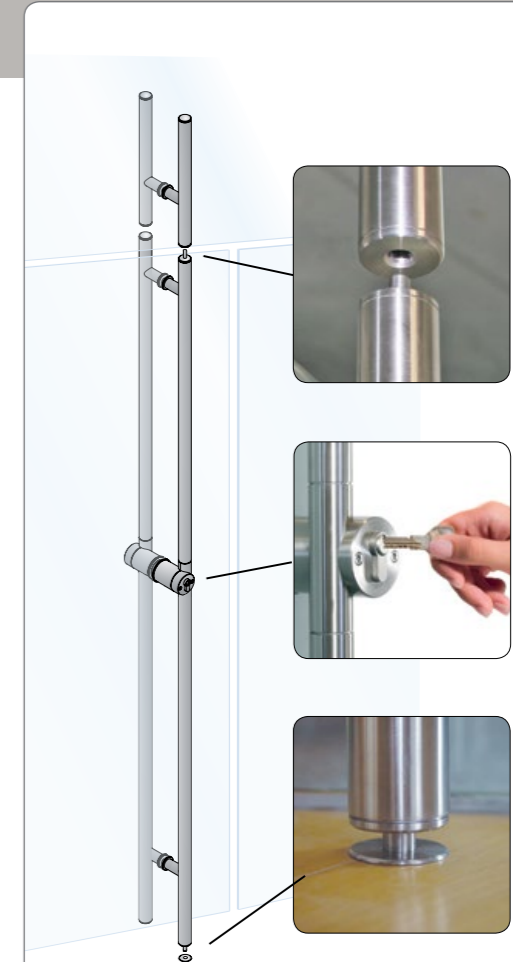

Weder Strecken noch Bücken – einfaches Verschieben in Griffhöhe! Perfekte Funktion und höchste Langlebigkeit zeichnen alle Stiletto Griffmodelle mit bodenschließbarem oder nach unten und oben (TG.1150.PZ/XL) verriegelndem Mechanismus aus.

No stretching, no bending down – just easy locking at handle height! All stiletto handles with floor locking or with top and bottom locking mechanism (TG.1150.PZ/XL) are characterized by perfect functionality and high longevity.



Bild zeigt hochglanzpolierte Ausführung  
Picture shows mirror-finished version



Balea TG.1140



Protec TG.1016



Klassik TG.1101



ProTec TG.1016



Unix TG.1007



Spider TG.1513



Luna TG.1511



Linea TG.1524



Solaris TG.1527



Planus TG.1038



Akzent TG.1039



Akzent R TG.1143



Bild zeigt hochglanzpolierte Ausführung  
Picture shows mirror-finished version

## MANUFAKTURGRIFFE

Im Bereich der Türgrifftechnik bietet Ihnen die MWE Edelstahlmanufaktur eine breite Produktpalette in allen erdenklichen Formen und Materialkombinationen.

Selbst die Fertigung von Sondergriffen nach Kundenwünschen ist – dank der hauseigenen und kompetenten Sonderkonstruktion – für MWE eine leicht umsetzbare Aufgabe. Mit Türgriffen von MWE setzen Sie klare gestalterische Akzente. Herausragende Funktionalität und perfekte Verarbeitung halten, was das außergewöhnliche Design verspricht.

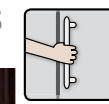
MWE Edelstahlmanufaktur offers a wide range of door handles in every conceivable form and combination of materials.

Even the production of custom handles is a welcome challenge thanks to our in-house design experts. MWE door handles set distinctive accents in any setting. Outstanding functionality and meticulous workmanship live up to the promise of the extraordinary design.

Bild zeigt hochglanzpolierte Ausführung  
Picture shows mirror-finished version



Griffmuschel | Flush pull  
GR.5941

Linea TG.1524

## GRIFFMUSCHELN



Griffmuschel | Flush pull  
GR.5948



Griffmuschel | Flush pull  
GR.6605/.H



Griffmuschel | Flush pull  
GR.6090



Griffmuschel | Flush pull  
GR.5941



Griffmuschel | Flush pull  
GR.5908



Griffmuschel | Flush pull  
GR.5905



Griffmuschel | Flush pull  
GR.6600



Griffmuschel | Flush pull  
GR.8030



Griffmuschel Rückseite  
Flush pull rear GR.8030

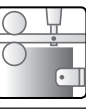

Die MWE-Soft-Stop-Technik sorgt für eine besonders komfortable Bedienung von MWE-Schiebetürsystemen. Kurz vor der Endposition übernimmt die Technik automatisch die Bewegung des Türblatts und sorgt für ein sanftes Öffnen und Schließen der Tür.

MWE soft stop technology ensures especially comfortable operation of MWE sliding door systems. Shortly before the door reaches its end position, the technology automatically stops the door leaf, ensuring gentle opening and closing.

### Rolle oben | Above-door roller

Automatik übernimmt | Öffnen und Schließen per Hand | Automatik übernimmt

Automation takes over | Opening and closing by hand | Automation takes over

Beispiel für Flachprofilaufschiene | System Akzent R  
Example: Akzent flat-profile rail | System Akzent R

### Rolle unten | Floor rollers

Automatik übernimmt | Öffnen und Schließen per Hand | Automatik übernimmt

Automation takes over | Opening and closing by hand | Automation takes over

Beispiel System Terra M  
Example: Terra M system



Detailansicht MWE-Soft-Stop-Technik im Flachprofil  
Detail of MWE soft stop technology with flat-profile rail



Detailansicht MWE-Soft-Stop-Technik im Deckenprofil  
Detail of MWE soft stop technology in ceiling track

## NEU! | NEW!

Beispiel für Rundprofilssystem  
Example: for round rails

### NEUE TECHNIK IM RUNDPROFIL

- Einfacher Austausch der Dämpfer – ohne Demontage der Tür!
- Getestet mit über 100.000 Zyklen
- Deutlich geringere Aufzugskraft – dadurch Verwendung von Griffmuscheln möglich!
- Langfristige Ersatzteilversorgung garantiert
- 5 Jahre Garantie



Detailansicht MWE-Soft-Stop-Technik im Rundprofil  
Detail of MWE soft stop technology for round rails

### NEW ROUND-PROFILE TECHNOLOGY

- Easy replacement of dampers – without disassembling the door!
- Tested in over 100,000 cycles
- Significantly less force needed to open door, making the use of flush pulls possible!
- Guaranteed long-term supply of spare parts
- 5-year warranty

Die MWE-Soft-Stop-Technik ist erhältlich für die Systeme | MWE soft stop technology is available for:  
Protec, Klassik, Supra, Chronos, Spider, Duplex, Duplex S (100 kg max. Türblattgewicht | max. door weight)  
Purist, Akzent R, Terra, Terra H, Terra M, Terra M XL, Terra Akzent (75 kg max. Türblattgewicht | max. door weight)

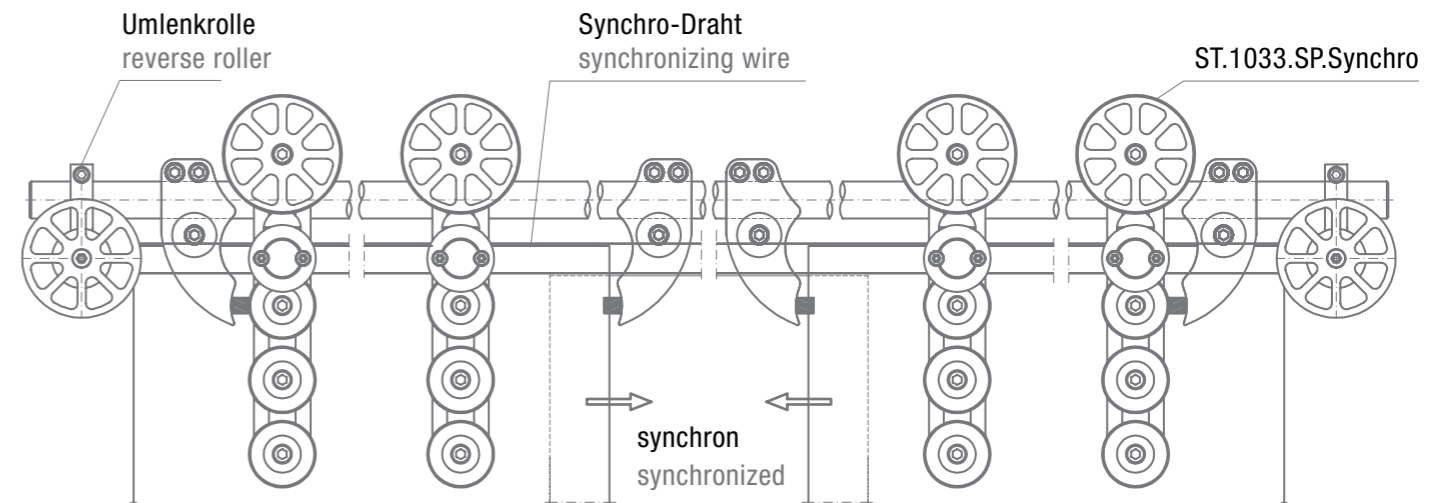

## Zweiflügelige Schiebetüren mit einer Hand öffnen ...

Bei der Synchrontechnik ermöglicht eine Drahtseil-Verbindung das gegenläufige Öffnen zweier Türflügel. Neben der ausgefeilten Technik besticht vor allem das anspruchsvolle Design der Synchronbeschläge, das eine komplexe Mechanik bewusst zur Schau stellt. Erhältlich ist die Synchrontechnik für die Schiebetürsysteme Klassik, Spider, Chronos, ProTec, Supra und Akzent zur Verwendung mit synchronegekoppelten, gegeneinander laufenden Glas- oder Holzschiebetüren.

## Double sliding doors that can be opened with one hand ...

Our synchronous technology uses a wire connection to enable the simultaneous opening of double doors in opposite directions. This sophisticated engineering is matched by the appealing design of the synchronous hardware, which deliberately showcases the complex mechanism. Synchronous technology is available for the Klassik, Spider, Chronos, ProTec, Supra and Akzent sliding door systems, to enable the synchronous opening of double glass or wood sliding doors.



### Doppelflügelige Schiebetür Double leaf sliding door system

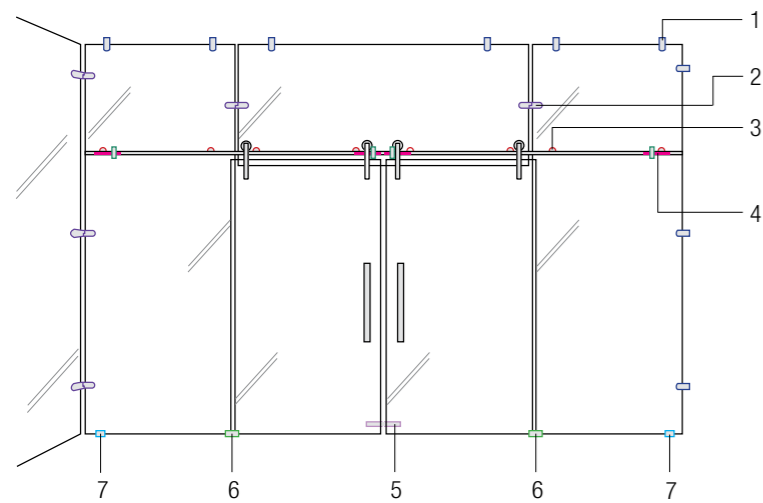

- 1 Glas-Boden-Deckenhalter  
Glass-floor-ceiling connector/adjustable
- 2 Glas-Glas-Eckverbinder  
Glass-glass corner connector
- 3 Glasbefestigungen für Laufschiene  
Glass fastener for round rails
- 4 Als Zubehör erhältlich **MWE-Soft-Stop-Technik**  
Accessorie: **MWE soft stop technology** (S./p 30)
- 5 Türblattstopper | Door leaf stop
- 6 Bodenführung | Floor guide

### Deckenhohe Schiebetür Floor-to-ceiling sliding doors

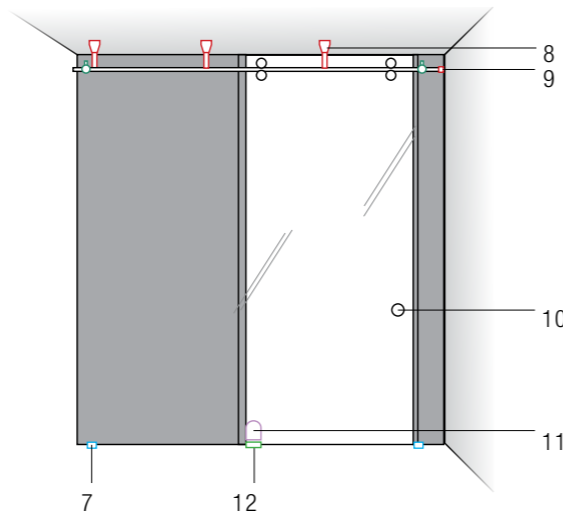

- 7 Bodenendstopper  
Floor-end-stop
- 8 Deckenhalter für Laufschiene  
Ceiling mount for rails
- 9 Stirnseitenbefestigung  
Front side fastener for rails
- 10 Griffmuschel | Flush pull (S./p 29)
- 11 Bodenschloss | Floor lock
- 12 Bodenführung für Bodenschloss  
Floor guide for floor lock

### Schiebetüren mit Bodenlaufschiene Sliding door with floor track

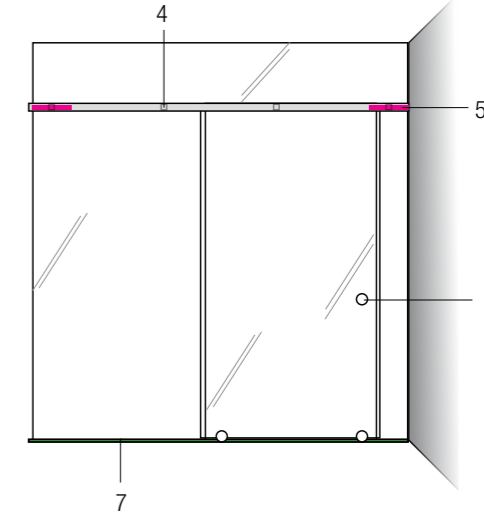
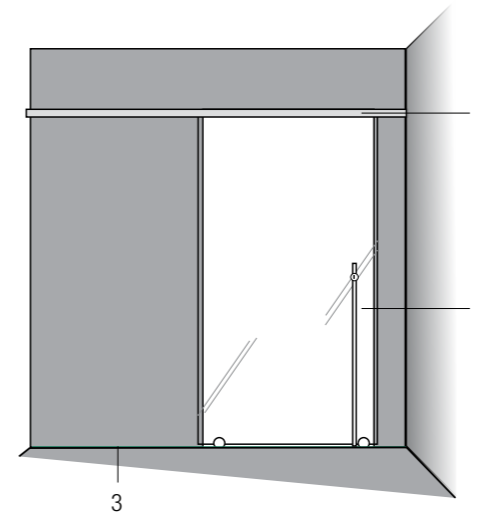

- 1 Führungsprofil Wand-Decke | Wall/Ceiling guide
- 2 PZ-Stilettgriff (alternativ) | Stiletto handle with profile cylinder
- 3 Eingelassene Bodenlaufschiene | Flush-mounted floor track
- 4 Glasbefestigung für Führungsprofil | Glass fastening for guide profile
- 5 **MWE-Soft-Stop-Technik** | **MWE soft stop technology** (S./p 30)
- 6 Griffmuschel | Flush pull (S./p 29)
- 7 Aufgeklebte Bodenlaufschiene | Glued floor track



ST.7001.V  
Glas-Boden-Deckenhalter/höhenverstellbar | Glass-floor-ceiling connector/adjustable



ST.7004.V  
Glas-Glas-Eckverbinder/winkelverstellbar | Glass-glass corner connector



ST.2170  
Glasbefestigung für Rundlaufschiene | Glass fastener for round rails

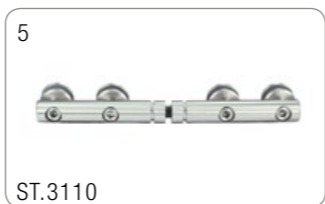

ST.3110  
Türblattstopper | Door leaf stop



ST.4008.8/10/12  
Bodenführung für Glas | Floor guide for glass



ST.4508.8/10/12  
Bodenendstopper (rechts/links einsetzbar) | Floor end stopper (right/left)



ST.5001  
Deckenhalter für Laufschiene | Ceiling fastener, adjustable



ST.5035  
Stirnseitenbefestigung für Rundlaufschiene | Front side fastener for rails



GR.5905  
Griffmuschel | Flush pull



ST.4100.SR  
Bodenschloss, gewölbt | Floor lock, round



ST.4008.SR-ST.4012.SR  
Bodenführung für gewölbt Bodenschloss | Floor guide for round floor lock

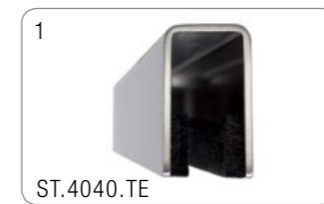

ST.4040.TE  
Führungsprofil Wand-Decke | Wall/Ceiling guide profile

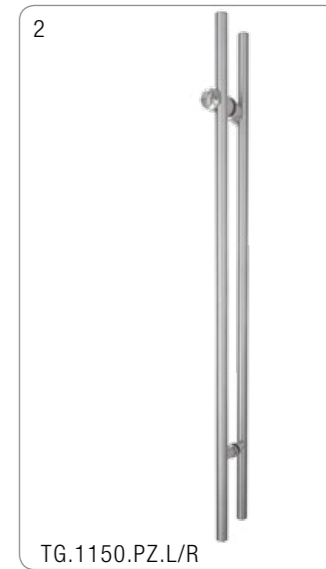

TG.1150.PZ.L/R  
Stilettgriffpaar PZ.L/R | Stiletto handle with profile cylinder

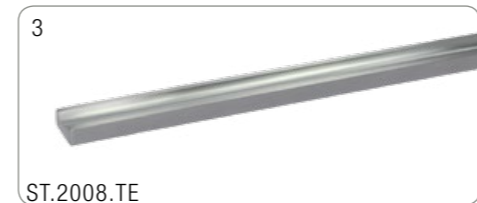

ST.2008.TE  
Bodenlaufschiene zum Einlassen (alternativ) | Floor track for flush mounting (alternative)

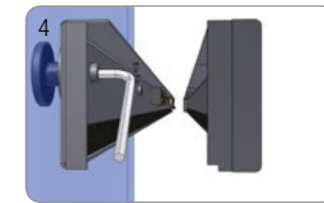

Glasbefestigung für 2-tlg. Führungsprofil | Glass fastener for 2-part guide profile



GR.5941.8/10/12  
Griffmuschel | Flush pull



ST.2000.TE  
Bodenlaufschiene für Terra-Schiebetürsysteme | Floor track for Terra sliding door system



Lange Bodenlaufschiene können durch Stecksysteme verbunden werden. | Long floor tracks can be connected with a seamless connector

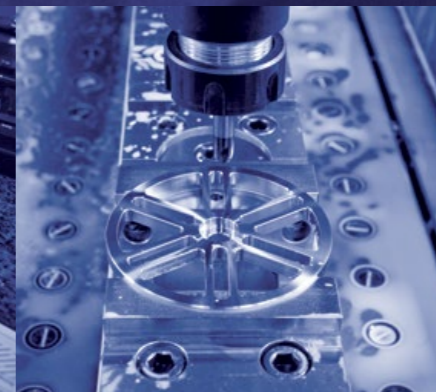

# DIE MANUFAKTUR

MWE steht für maximale Verarbeitungsqualität und große Liebe zum Detail. Es ist unsere Philosophie und Aufgabe, Produkte zu entwickeln, die in jeder Hinsicht dem Zeitgeist entsprechen. Was für alle MWE-Mitarbeiter bedeutet, jederzeit den höchsten Anforderungen hinsichtlich Design, Verarbeitungsqualität und Funktionalität gerecht zu werden. MWE-Spitzentechnologie gepaart mit einer vorbildlichen Kundenkommunikation, das ergibt „Qualität aus Leidenschaft“!

# MANUFACTORY

MWE stands for the best in product quality and attention to every last detail. It is our philosophy and our mission to develop products that are in step with the times in every way. All of us at MWE are committed to satisfying the highest demands in terms of design, workmanship and functionality. Cutting-edge MWE technology combined with exemplary customer communication – that’s what we mean by “quality built on passion.”



Türen | Doors



Leitern | Ladders



Duschen | Showers



Türgriffe | Door Handles

Übersicht Produktkataloge | Overview catalogues:



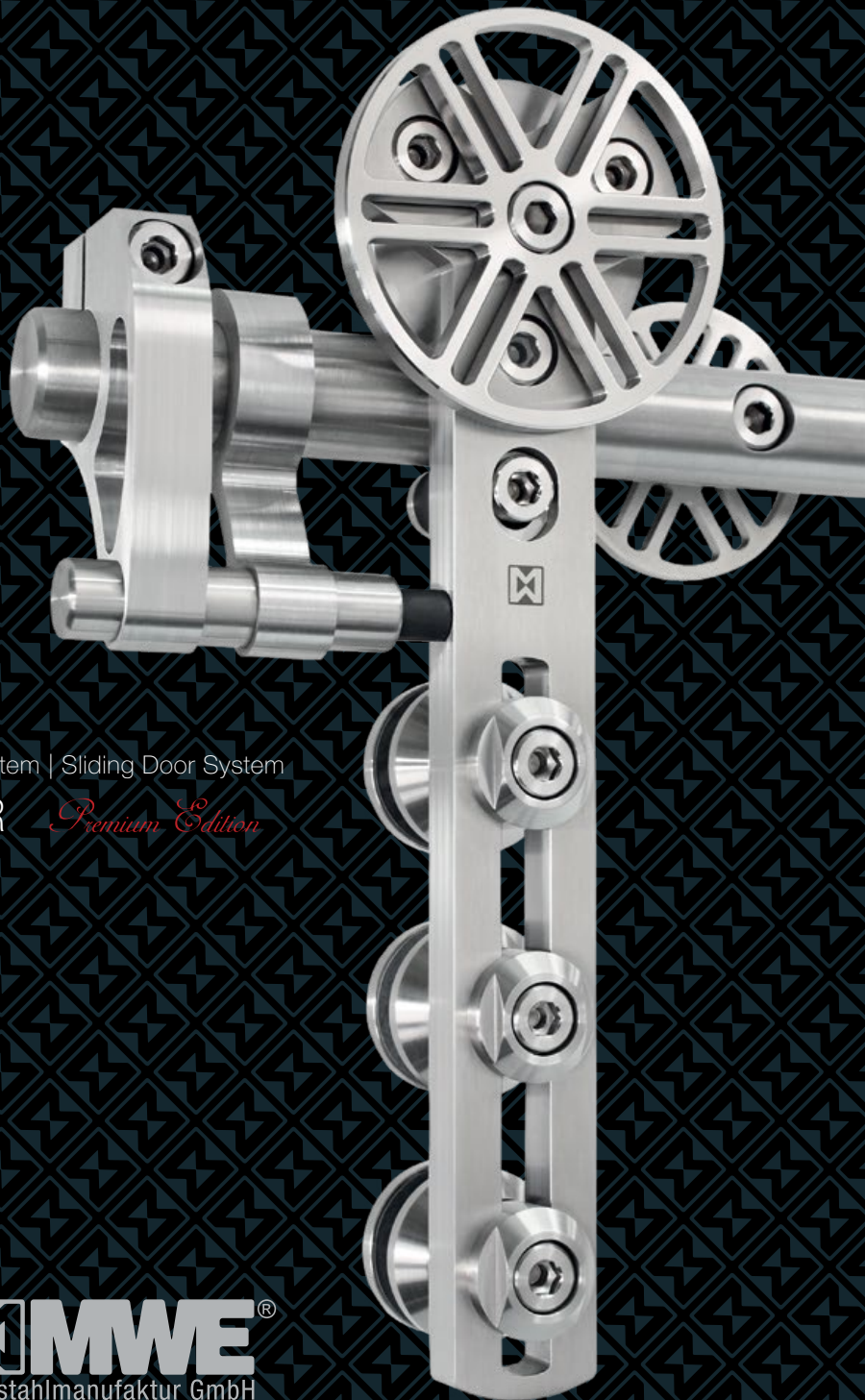

Schiebetürsystem | Sliding Door System

SPIDER *Premium Edition*

**MWE**<sup>®</sup>  
Edelstahlmanufaktur GmbH

Fachhändler-Distributor:

[www.mwe.de](http://www.mwe.de)